

PEÇAS NUMERADAS / NUMBERED PARTS /
PIEZAS NUMERADAS

EX: 1915X-X 10 (peça/ piece/ pieza number)

DIMENSÕES DO PRODUTO / PRODUCT DIMENSIONS / DIMENSIONS PRODUCT - WxDxH / LxPxA - 1800 X 468 X 2050 MM

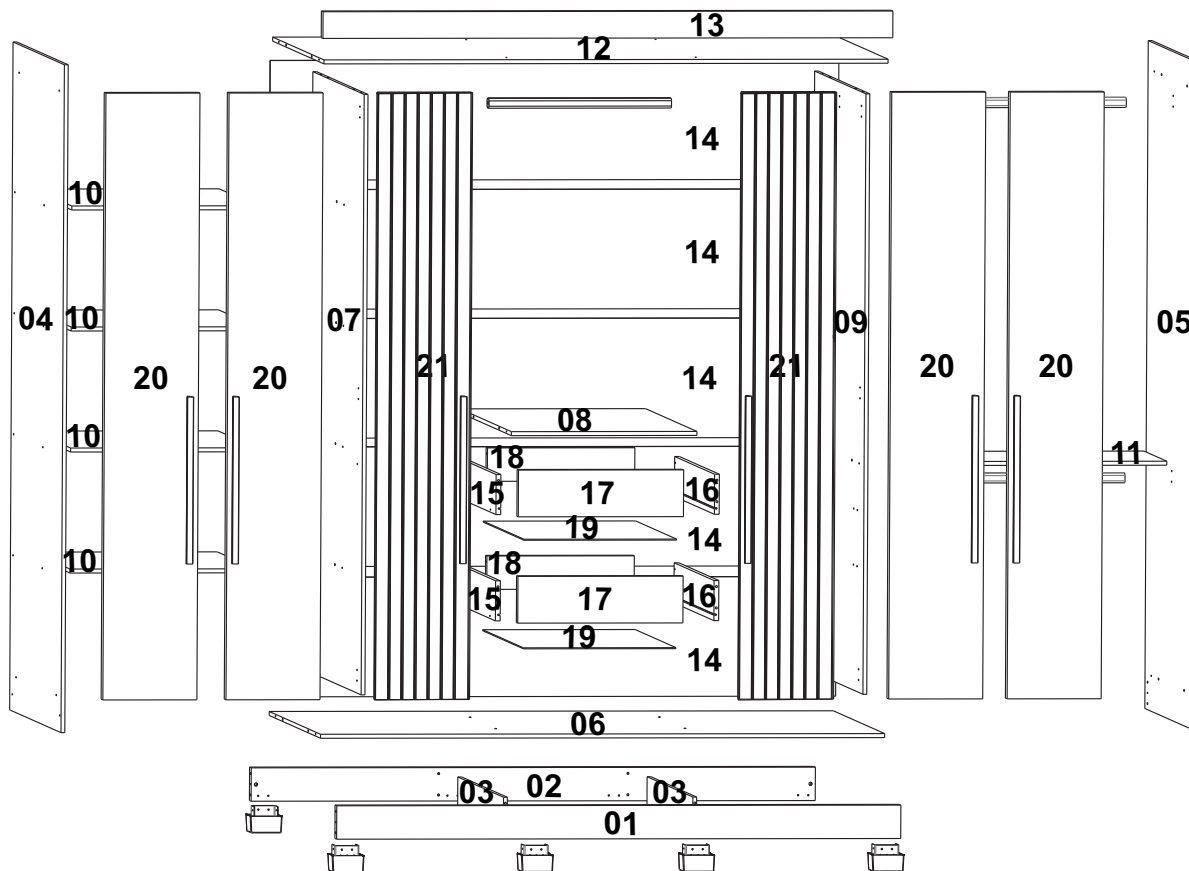
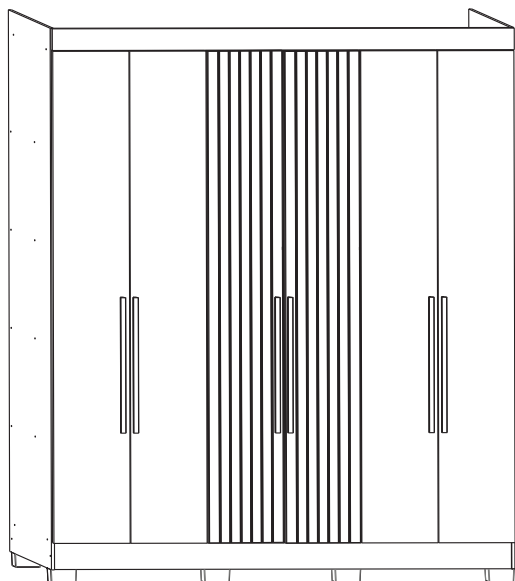

ATENÇÃO / ATTENTION / ATENCION

Nunca utilizar óleos, lustra móveis, produtos abrasivos, saponáceos, esponja de aço e outros.

Never use oils, furniture polish, abrasive products, soaps, steel sponge and others.

Nunca use aceites, pulimentos, abrasivos, jabones, esponja de acero y otros.

CUIDADOS ESPECIAIS/ SPECIAL CARE/ CUIDADOS ESPECIALES

- Evitar expor o móvel ao sol, e em lugares úmidos.
- Limpar com flanela seca ou com pano levemente umedecido em água.
- Avoid exposing the furniture to the sun, and in damp places.
- Clean with dry flannel or lightly cloth moistened with water.
- Evite exponer los muebles al sol y en lugares húmedos.
- Limpiar con flanela seca o un paño ligero, humedecido con agua.

MONTAR O PRODUTO SOBRE A EMBALAGEM, EVITANDO DANOS NA PINTURA. ACONSELHAMOS QUE A MONTAGEM DO PRODUTO SEJA POR UM PROFISSIONAL.

SETUP THE PRODUCT ON TOP OF THE PACKAGING, AVOIDING DAMAGE TO THE PAINT. WE RECOMMEND THAT THE INSTALLATION IS DONE BY A PROFESSIONAL.

MONTAR EL PRODUCTO EN EL PAQUETE, EVITAR LESIONES EN PINTURA. AVISAMOS QUE EL MONTAJE DEL PRODUCTO SEA UN PROFESIONAL.

Ferramentas necessárias / Necessary tools / Herramientas Necesarias (não fornecidas) (not provided) (No proporcionadas)

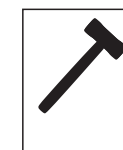
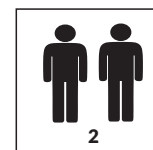

MEDIDA UTILIZADA EM MM / UNIT MEASURE USED IS MILLIMETERS (MM)

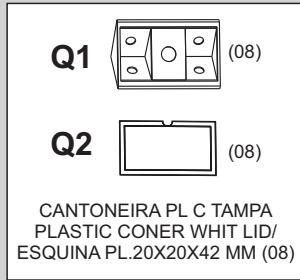
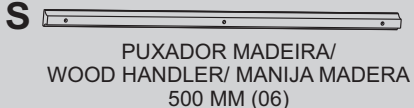
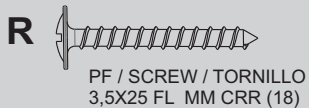
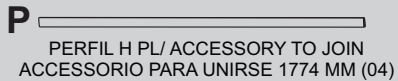
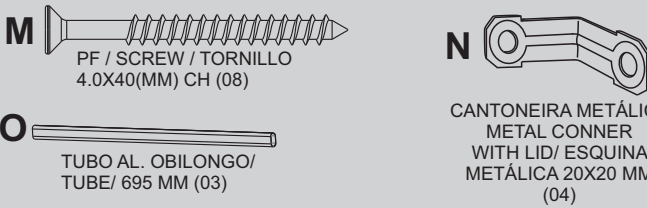
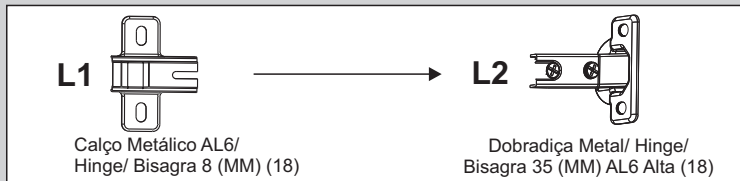
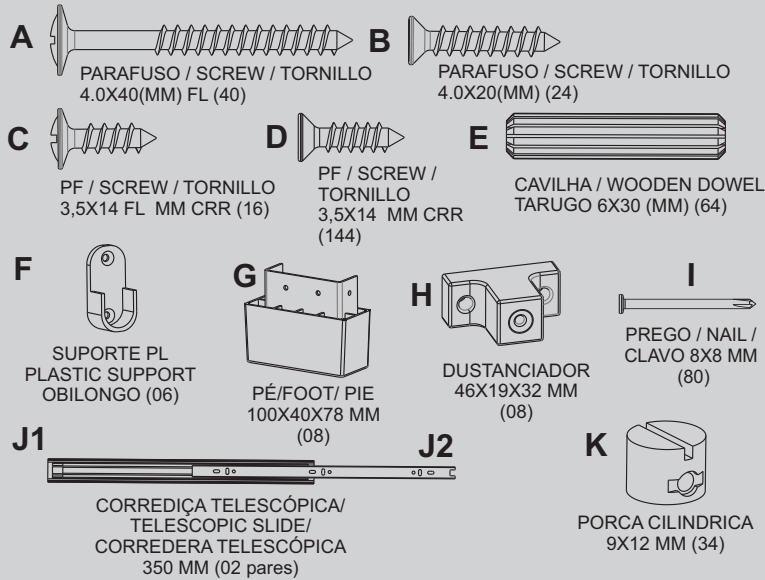

ITEM		DESCRIÇÃO DA PEÇAS / DESCRIPTION OF PARTS / UNIT MEASURE USED IS MILLIMETERS (MM)				CORES DO PRODUTO / PRODUCT COLORS / COLORES DEL PRODUCTO			
COD. CODE	Nº	NOME/NAME/NOMBRE	MEDIDAS / MEASURES (MM)	TIPO TYPE	QUANT AMOUNT CANTIDAD	OFF WHITE	PRETO BLACK NEGRO	FREIJÓ / OFF WHITE	FREIJÓ / OFF WHITE
18490	1	RODAPÉ FRONT/	1776X100X15	MDP	01	01/06	01/07	01/18	01/18
18491	2	RODAPÉ TRÁS/	1776X100X15	MDP	01				
18492	3	RODAPÉ CENTRAL/	401X100X12	MDP	02	03/06	03/07	03/18	03/18
18493	4	LATERAL ESQUERDA/ LEFT SIDE/ LADO IZQUIERDO	2000X450X12	MDP	01	04/06	04/07	04/18	04/18
18494	5	LATERAL DIREITA/ RIGHT SIDE/ LADO DERECHO	2000X450X12	MDP	01	05/06	05/07	05/18	05/18
18495	6	BASE	1776X450X12	MDP	01	06/06	06/07	06/18	06/18
18496	7	DIVISOR ESQ /LEFT DIVIDER	1798X450X12	MDP	01	07/06	07/07	07/18	07/18
18497	8	PRATELEIRA CENTRAL/ CENTRAL SHELF/ ESTANTE CENTRAL	584X450X12	MDP	01	08/06	08/07	08/18	08/18
18498	9	DIVISOR DIR/	1798X450X12	MDP	01	09/06	09/07	09/18	09/18
18499	10	PRATELEIRA ESQ /LEFT SHELF/ ESTANTE IZQUIERDO	584X335X12	MDP	04	10/06	10/07	10/18	10/18
18500	11	PRATELEIRA DIR /RIGHT SHELF/ ESTANTE DERECHA	584X200X12	MDP	01	11/06	11/07	11/18	11/18
18501	12	TAMPO/ TOP	1776X450X12	MDP	01	12/06	12/07	12/18	12/18
18502	13	VISTA SUPERIOR/	1794X80X15	MDP	01	13/06	13/07	13/18	13/18
18503	14	FUNDO TRÁS/ BACK / TRASEIRO	1790X358X3	MDF	05	14/06	14/07	14/18	14/18
18504	15	LATERAL GAV. ESQ/ LEFT DRAWER SIDE/ LADO CAJÓN IZQUIERDO	350X120X15	MDP	02	15/06	15/07	15/18	15/18
18505	16	LATERAL GAV. DIR/ RIGHT DRAWER SIDE/ LADO CAJÓN DERECHO	350X120X15	MDP	02	16/06	16/07	16/18	16/18
18506	17	FRENTE GAVETA/ DRAWER FRONT/ CÁJÓN DELANTERO	520X140X12	MDP	02	17/06	17/07	17/18	17/18
18507	18	CONTRA FRENTE/ AGAINST DRAWER FRONT/CONTRA EL FRENTE DEL CAJÓN	464X100X12	MDP	02	18/06	18/07	18/18	18/18
18508	19	FUNDO GAVETA/ DRAWER BACK/ FONDO DEL CAJÓN	480X358X3	MDF	02	19/06	19/07	19/18	19/18
18509	20	PORTA / DOOR/ PUERTA	1817X296X15	MDP	04	20/06	20/07		
18510	21	PORTA C/ FRISOS/ DOOR/ PUERTA	1817X296X15	MDP	02	21/06	21/07		21/18
439	A	Parafuso / Screw / Tornillo 4,0x40 (MM) FL			40				
433	B	Parafuso / Screw / Tornillo 4,0x20 (MM) CH			24				
950	C	Parafuso / Screw / Tornillo 3,5x14 (MM) FL			16				
986	D	Parafuso / Screw / Tornillo 3,5x14 (MM) CH			156				
16545	E	Cavilha / Wooden Dowel / Tarugo 6x30 (MM)			64				
341	F	Suporte PL Obilongo/ Obolongo PL Support			06	CINZA		CINZA	CINZA
18567	G	Pés/ Foot/ Pies- 100x40x78 (MM)			08		PRETO		
18400	H	Distanciador 46x19x32 (MM)			08	CINZA		CINZA	CINZA
152	I	Prego / Nail / Clavo 8x8 (MM)			80				
13495	J1/ J2	Corred./Metallic Slid/ Corredera/ 350 MM (02 PAIR)			04				
18368	K	Porca Cilíndrica 9x12 (MM)			34				
18029	L1/ J2	Dobradiça Metálica/ Hinge/ Bisagra 35 (MM) AL6 ALTA			18				
438	M	Parafuso / Screw / Tornillo 4,0x40 (MM) CH			08				
132	N	Cantoneira Metal/ Angle Metal/ Esquina Metálica 20x20 mm			04				
11137	O	Tubo AL obilongo/ Tube 695X14 (MM)			03				
18568	P	Perfil H PL/ Accessory To Join/ Accessorio P. Unirse 1774X20X4 (MM)			04		PRETO		
18401	Q1/ Q2	Cantoneira PL/Plast. corner with lid / Esquina PL. 20X20X42(MM)			08	BRANCO		MARROM	MARROM
15175	R	Puxador Metálico/ Metal Handler/ Manija Metalico 170 (MM)			06	CINZA	CINZA	CINZA	CINZA
18588	S	Certif. de Garant. / Warranty Certif.			01	BRONZE	BRONZE	BRONZE	BRONZE

PREPARAÇÃO DE PEÇAS/ PARTS PREPARATION / PREPARACION DE PIEZAS

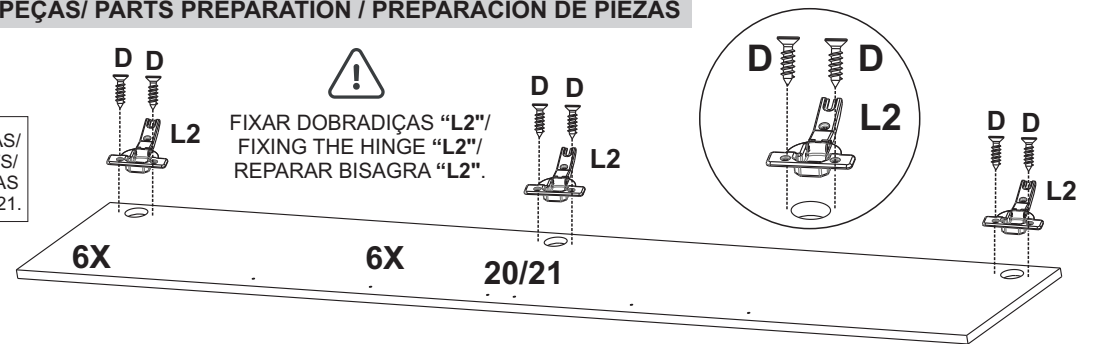
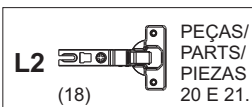
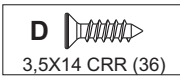

• Parafusar nos furos oblongos / Screw into oblongs roles / Atornillar en agujeros oblongos

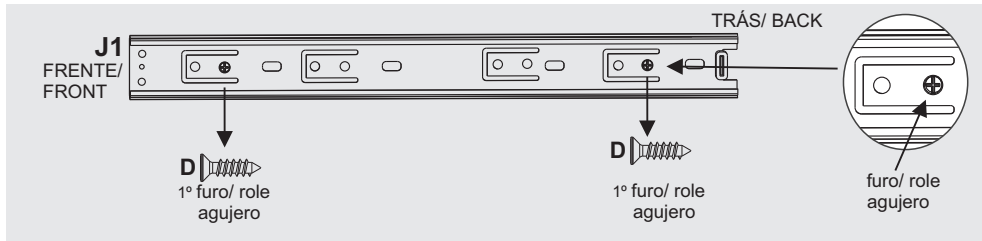

• Fixação da Corrediça / Slide Fixation / Fijación de Corredera

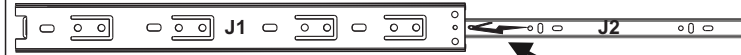

- Vire a corrediça e puxe a peça J2 até o final do seu curso, aperte a trava para soltá-la, retire e parafuse J1 nas peças 07 e 09.
- Turn the slide and pull the J2 piece to the end of its course, tighten the lock to release it, remove and screw J1 on parts 07 and 09.
- Gire la corredera y tire de la pieza J2 hasta el final de su recorrido, apriete el bloqueo para liberato, retire y atornille J1 las piezas 07 y 09.

Empurre a trava para cima/
Push the latch up/
Empujar el pestillo hacia arriba

PREPARAÇÃO DE PEÇAS/ PARTS PREPARATION / PREPARACION DE PIEZAS

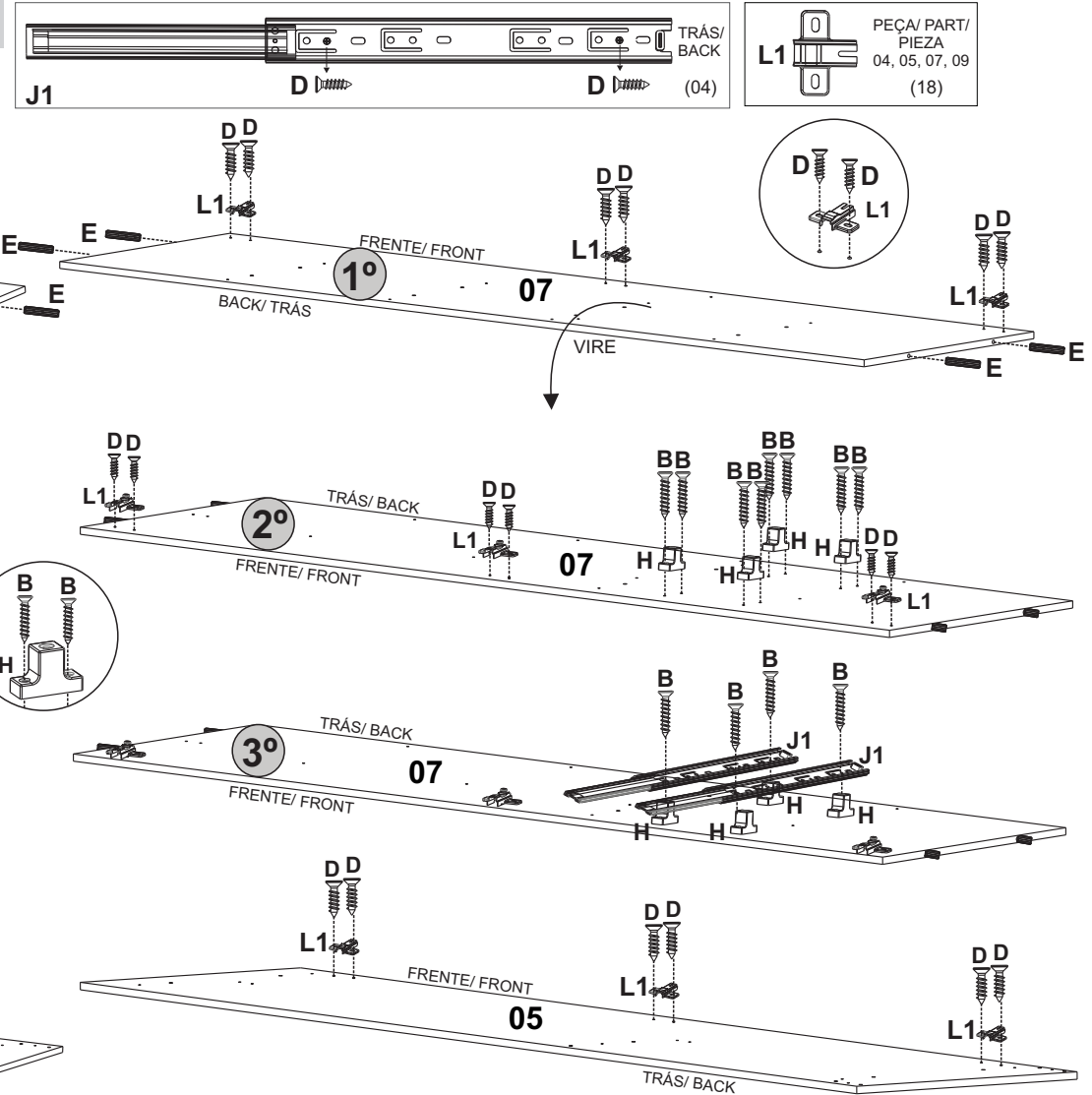
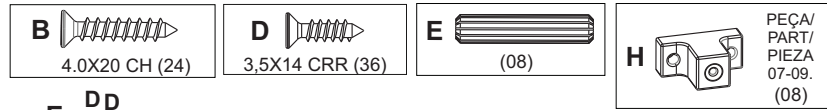

PREPARAÇÃO DE PEÇAS / PARTS PREPARATION / PREPARACION DE PIEZAS

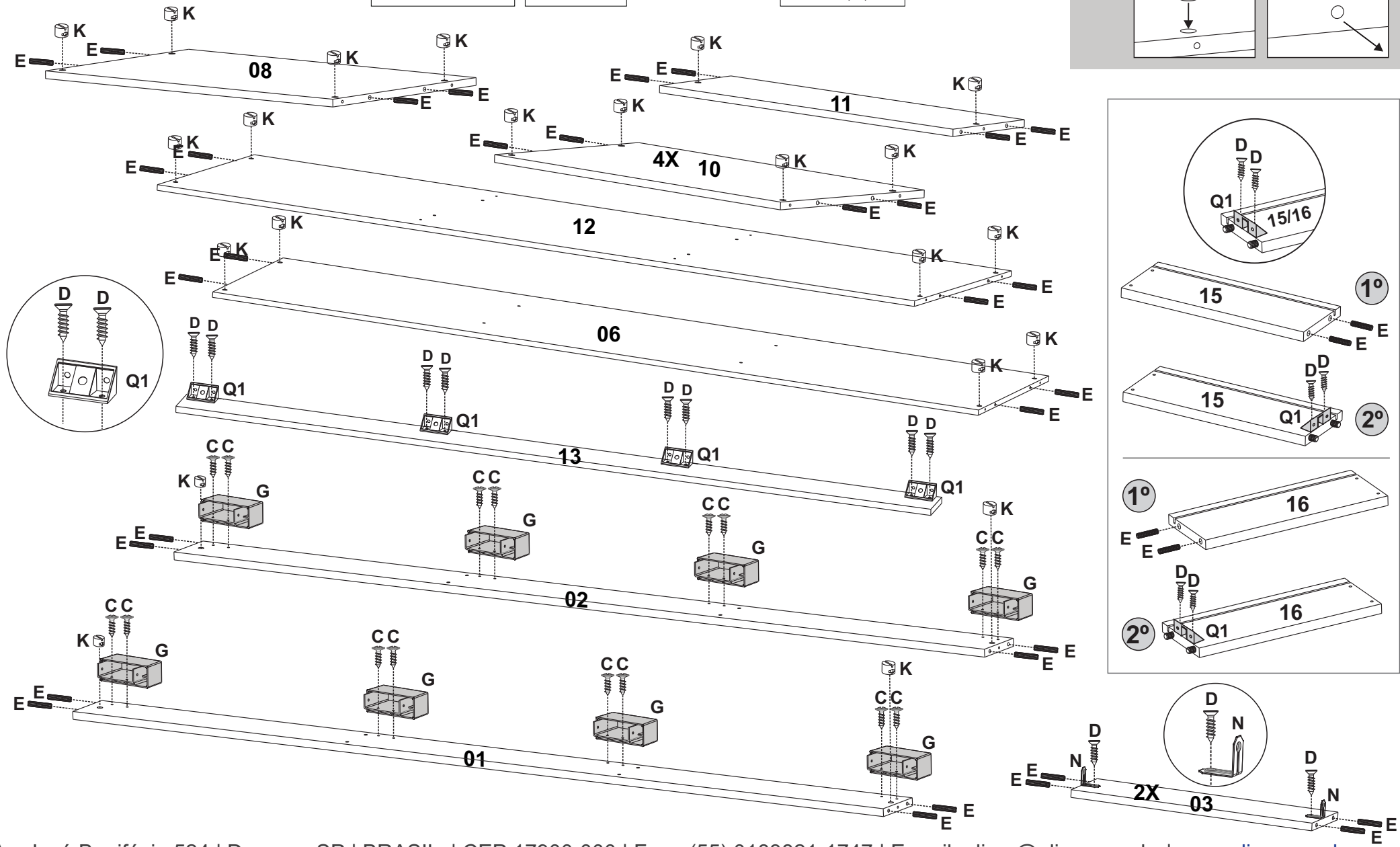
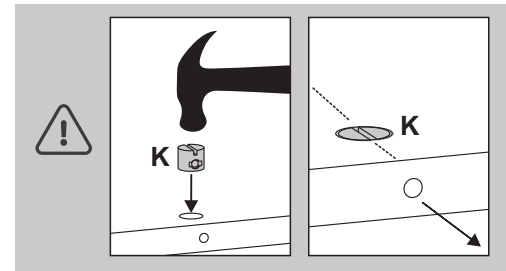
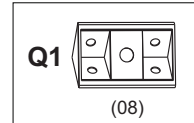
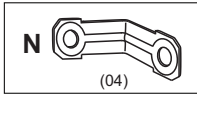
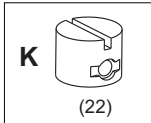
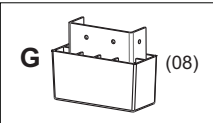
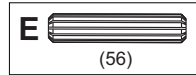
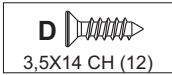
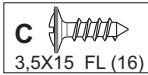

1 Obs: As peças pintadas nos passos são apenas ilustrativas.
The parts painted in the steps are illustrative only.
Las partes pintadas en los pasos son solo ilustrativas.

D=04

D 3,5X14 CRR (04)

2

1º **2º**

A **D**

A=04
D=08

A **D**

A

Parafusar Pé/ Screw Foot
Atornillar Pies
Peças/ Parts/ Piezas
03 / 04 / 05.

3

A=10

A 4.0X40 FL

4

A=04

A 4.0X40 FL

5

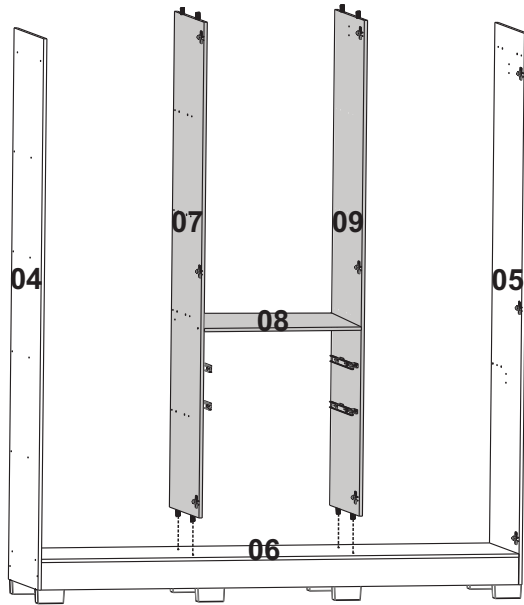

FRENTE/ FRONT

6

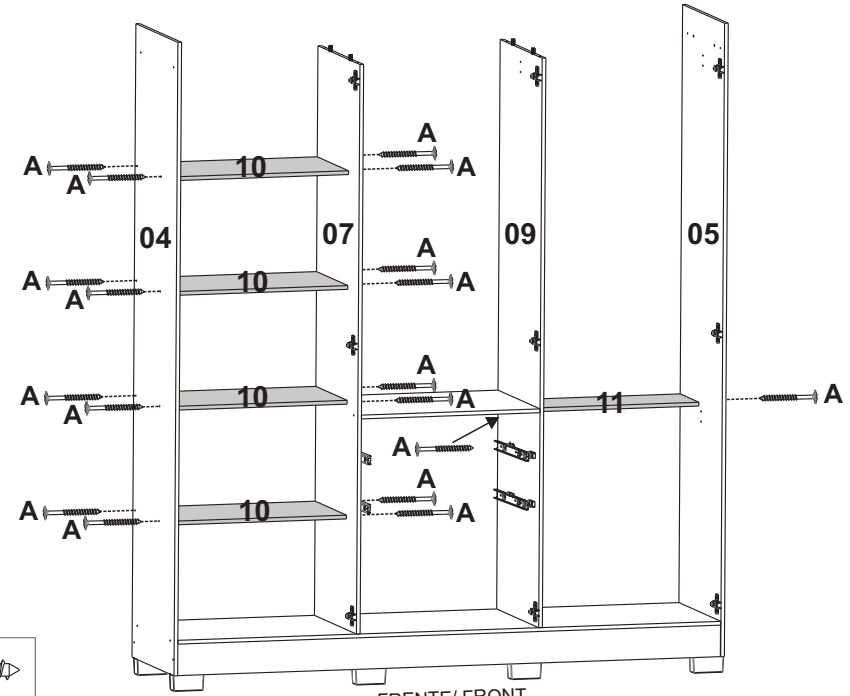
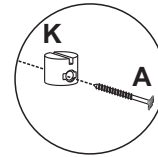
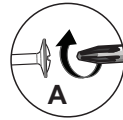

FRENTE/ FRONT

A=18

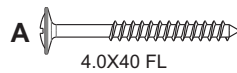

7

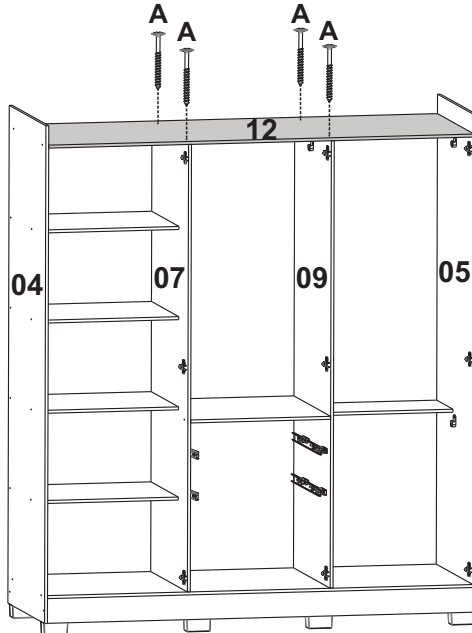
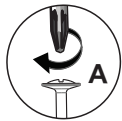

FRENTE/ FRONT

A=04

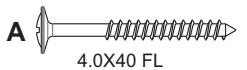

8

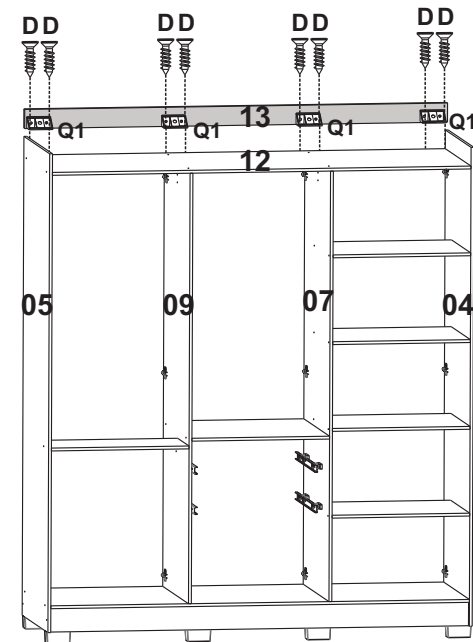

TRÁS/ BACK

D=08

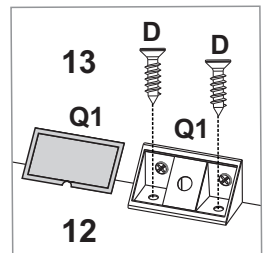
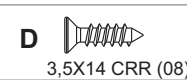

9

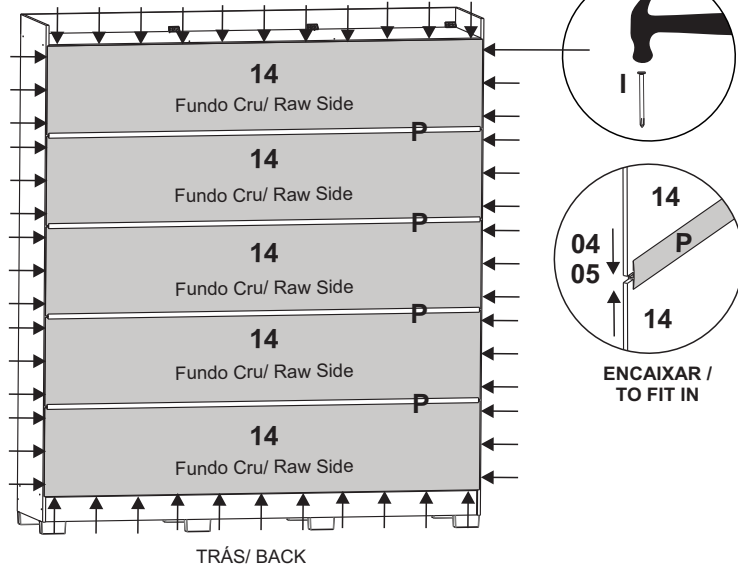

I=80
P=04

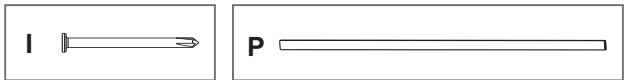

10

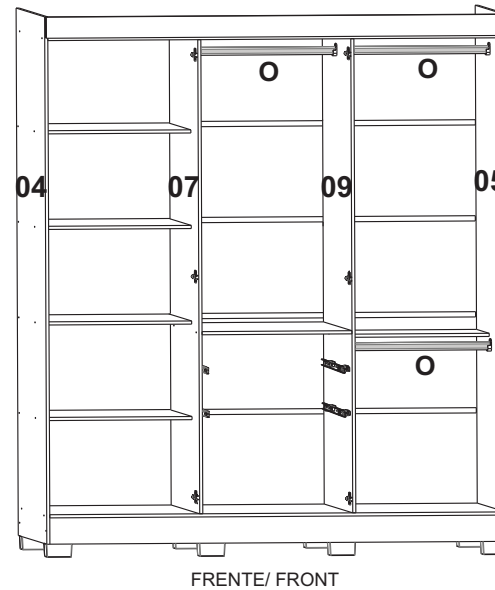

⚠
ATENÇÃO/ ATTENTION /
ATENCION

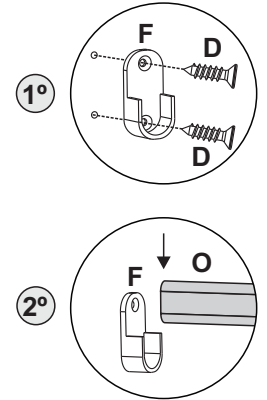

D=12
F=06
O=03

D
3,5X14 CRR



11

MONTAGEM GAVETA / ASSEMBLY OF THE DRAWER / MONTAJE LE CÁJON

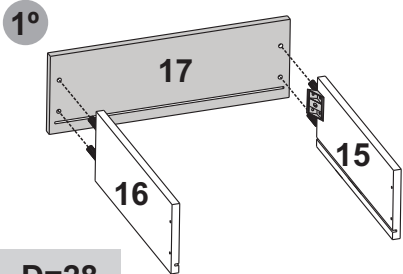

D=28
J2=04
M=08
Q2=04

D
3,5X14 CRR

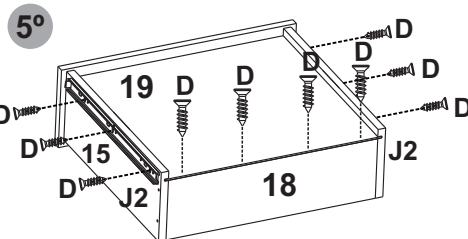
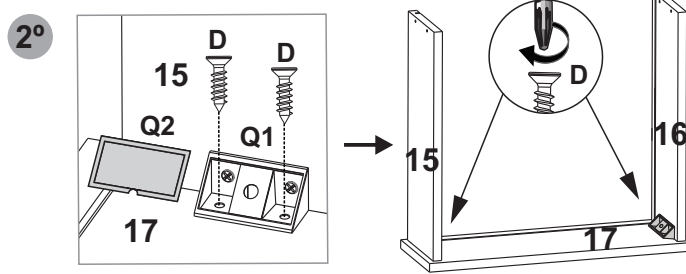
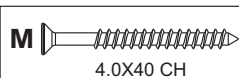
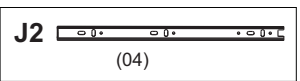

3º

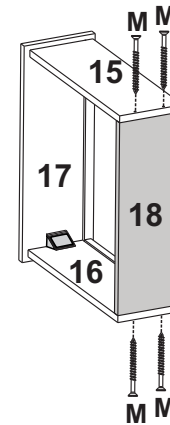

4º

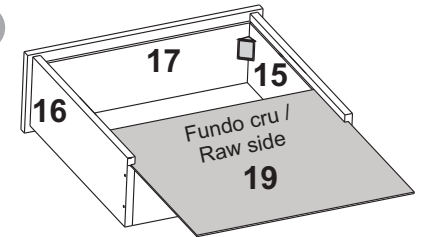

• Parafusar nos furos oblongos / Screw into oblongs roles / Atornillar en agujeros oblongos

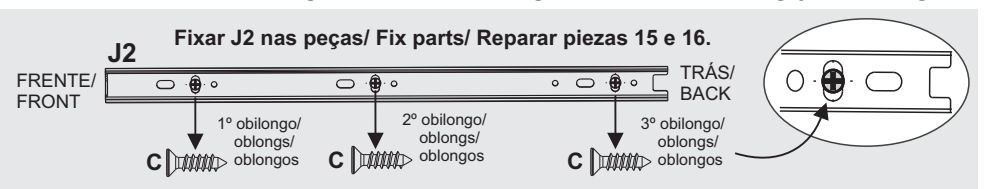

12

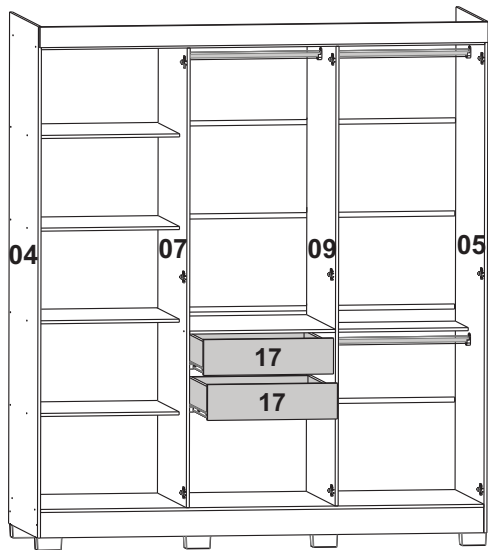

FRETE/ FRONT

13

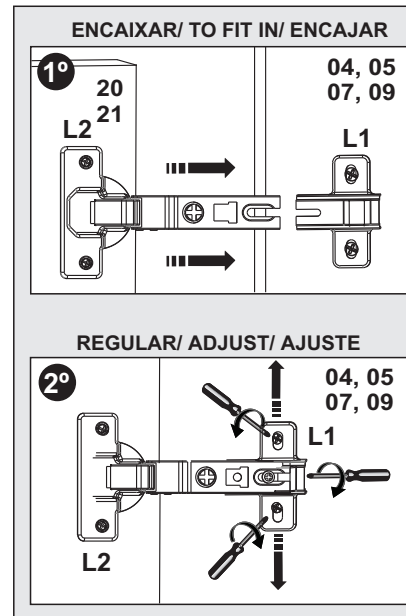
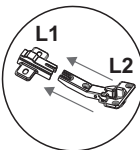
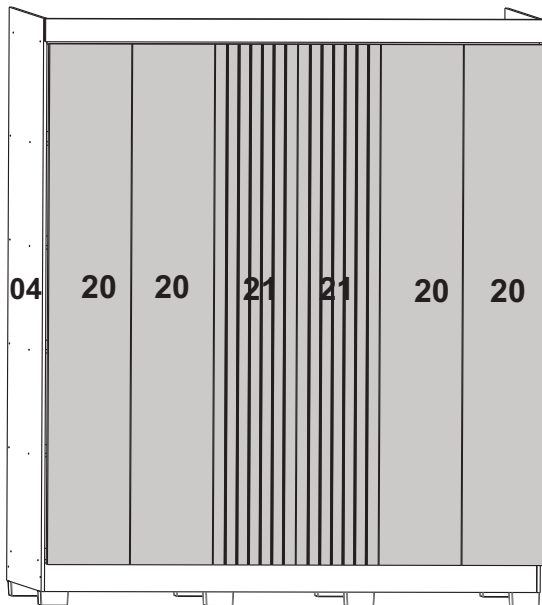

14

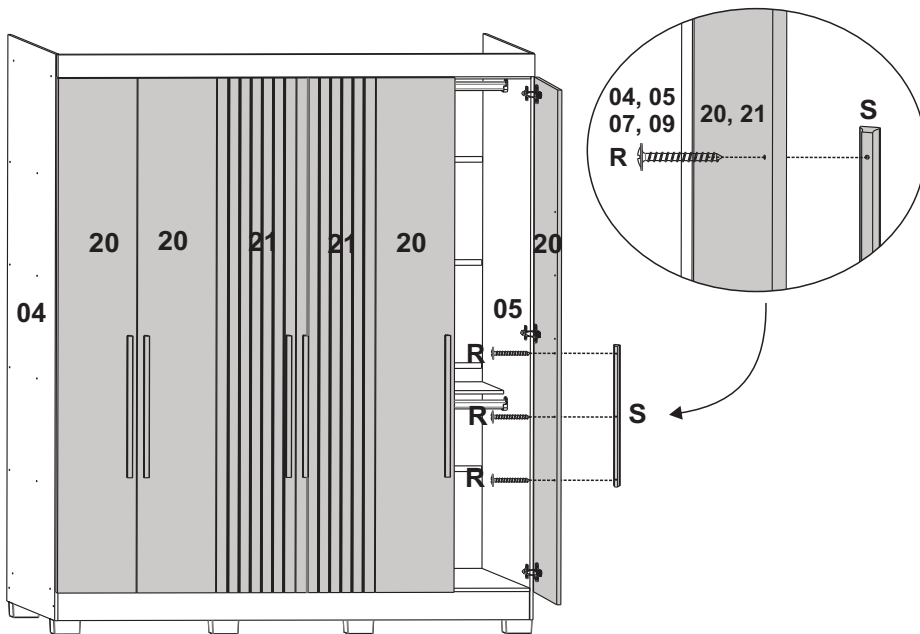

R=18
S= 06

