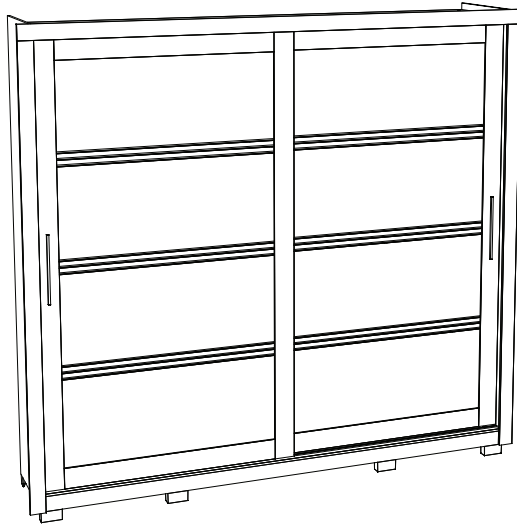
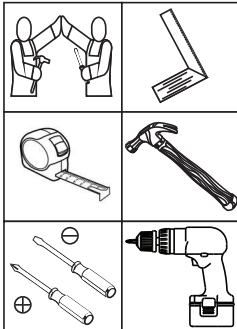

HENNInd. e Com. de Móveis Henn
Mondaí - SC - Brasil

☎ +55 49 3674.3500

📧 @moveishenn
www.henn.com.br**INSTRUÇÕES DE
MONTAGEM**INSTRUCCIONES DE MONTAJE
ASSEMBLY INSTRUCTIONS**Roupeiro Medelín 02 Portas Deslizantes | Armario Medelín 02 Puertas
Deslizantes Wardrobe Medelín 02 Sliding Doors**D326-127 Nature/Off White
D326-215 Nature/Preto HP**Requisitos para montagem
Requisitos para la montaje
Assembly Requirements**

Imagens meramente ilustrativas,
não acompanha o produto.
Imágenes ilustrativas, no incluidas
con el producto.
Illustrative images, not included
with the product.

AVISO

Para limpeza de seu móvel, use uma flanela seca ou umedecida, e não utilize produtos químicos que possam danificar seu produto.

SISTEMA DE MONTAGEM

O sistema de montagem dos produtos, funciona de acordo com a ordem crescente dos números indicados no desenho. Ex: 01, 02, 03, 04... até a conclusão da montagem.

ASSISTÊNCIA TÉCNICA

Para solicitação de Assistência Técnica você consumidor deverá entrar em contato com o Lojista a qual você realizou a compra deste produto e solicitar a assistência técnica das peças avariadas. A garantia abrange todas as peças, partes e componentes que eventualmente venham apresentar defeito de fabricação no prazo de 03 (três) meses, contando a partir da entrega do produto ao consumidor, mediante nota fiscal de compra. Se houver qualquer alteração na estrutura do produto ou ocorrer defeito por negligência do montador/consumidor em relação a instrução de montagem e manuseio, não será fornecido assistência técnica gratuita.

ADVERTENCIA

Para limpeza de su móvil, use una flanela seca o húmeda, y no utilice productos químicos que puedan dañar su producto.

SISTEMA DE MONTAJE

El sistema de montaje de los productos funciona de acuerdo con el orden creciente de los números indicados en el dibujo. Ej.: 01, 02, 03, 04... hasta la conclusión del montaje.

ASISTENCIA TÉCNICA

Para solicitar Asistencia Técnica, el consumidor debe comunicarse con el Comercio que usted realizó la compra de este producto y solicita asistencia técnica para las partes dañadas. La garantía cubre todas las partes, piezas y componentes que eventualmente puedan presentar defecto de fabricación en el plazo de 03 (tres) meses, contados a partir de la entrega del producto al consumidor, mediante factura de compra. Si se produce algún cambio en la estructura del producto o se produce un defecto por negligencia del montador/consumidor en relación con las instrucciones de montaje y manipulación, no se prestará asistencia técnica gratuita.

NOTICE

To clean your furniture, use a dry or wet cloth, and do not use chemicals that may damage your product.

ASSEMBLY SYSTEM

The products' assembly system works according to the increasing order of the indicated numbers. For example: 01, 02, 03, 04 ... to the end of the assembly.

TECHNICAL ASSISTANCE

To request Technical Assistance, the consumer must contact the retailer from whom you purchased this product and request technical assistance for the damaged parts. The warranty covers all parts, parts and components that may eventually present a manufacturing defect within a period of 03 (three) months, counting from the delivery of the product to the consumer, by means of a purchase invoice. If there is any change in the structure of the product or defect occurs due to negligence of the assembler/consumer in relation to the assembly and handling instruction, free technical assistance will not be provided.

ACESSÓRIOS | ACCESORIOS | ACCESSORIES

A



x8

B



x29

C



x8

D



x8

E



x81

F



x163

G



x36

H



x4

I

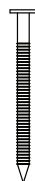

x8

J



x114

K



x240

L

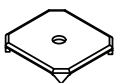

x74

M

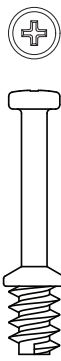

x3

N



x3

O

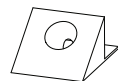

x8

Parafusos em escala
Tornillos escalados
Scaled screws

1:1

ACESSÓRIOS | ACCESORIOS | ACCESSORIES



x8

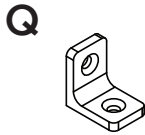

x22

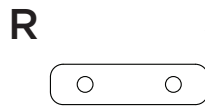

x38



x6

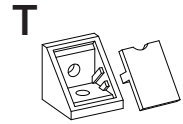

x13

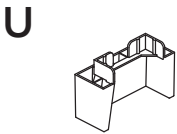

x9

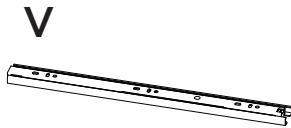

x4 PAR



x3

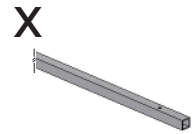

x2

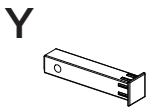

x1 KIT

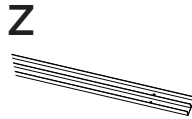

x1



x1

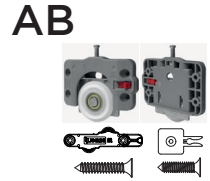

x1 KIT

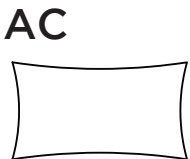

x2



x32



x6

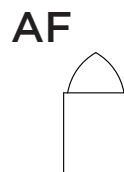

x3



x1

LISTA DE PEÇAS | LISTA DE PIEZAS | LIST OF PIECES ITM/D326-

Item	Caixa Caja Box	Qty Ctd Qty	Descrição Descripción Description	Dimensões (mm) Dimensiones (mm) Dimensions (mm)		
				Comprimento Largo Length	Largura Ancho Width	Espessura Grosor Thickness
1	2/4	1	RODAPÉ FRONTAL FALDÓN DELANTERO FRONT SKIRTING	2372	73	12
2	1/4	3	TRAVESSA DO RODAPÉ PLACA DE RODAPIÉ SKIRTING PLATE	470	73	12
3	2/4	1	RODAPÉ TRASEIRO REPOSAPIÉS TRASERO BACK FOOTBOARD	2372	73	12
4	2/4	1	BASE BASE BASE	2372	500	12
5	3/4	1	LATERAL ESQUERDA LATERAL IZQUIERDA LEFT SIDE	2250	500	12
6	1/4	1	DIVISÃO ESQUERDA DIVISIÓN IZQUIERDA LEFT DIVISION	700	410	12
7	4/4	1	DIVISÃO SUPERIOR ESQUERDA DIVISIÓN SUPERIOR IZQUIERDA UPPER LEFT DIVISION	1045	355	12
8=13	1/4	1	TAMPO DAS GAVETAS TAPA DE LOS CAJONES TOP OF DRAWERS	596	410	12
9	3/4	1	DIVISÃO CENTRAL DIVISION CENTRAL CENTRAL DIVISION	1757	355	12
10=14	1/4	3	PRATELEIRA ESTANTE SHELF	584	350	12
11	1/4	1	DIVISÃO DIREITA DIVISIÓN DERECHA RIGHT DIVISION	700	410	12
12	4/4	1	DIVISÃO SUPERIOR DIREITA DIVISIÓN SUPERIOR DERECHA UPPER RIGHT DIVISION	1045	355	12
13=8	1/4	1	TAMPO DAS GAVETAS TAPA DE LOS CAJONES TOP OF DRAWERS	596	410	12
14=10	1/4 e 3/4	4	PRATELEIRA ESTANTE SHELF	584	350	12
15	2/4	1	CHÃO DO MALEIRO REPISA SUPERIOR FLOOR OF MALEIRO	2372	410	12
16	1/4	1	RIPA DO MALEIRO TRAVESAÑO SUPERIOR MALEIRO'S LATH	350	73	12
17	2/4	1	TAMPO SUPERIOR TAPA SUPERIOR TOP PANEL	2372	500	12
18	3/4	1	LATERAL DIREITA LADO DERECHO RIGHT SIDE	2250	500	12
19	2/4	4	RIPA LATERAL RIPA LATERAL SIDE CLAPBOARD	351	80	25
20	2/4	1	MOLDURA SUPERIOR MARCO SUPERIOR FRAME SUPERIOR	2502	73	12
21	2/4	2	MOLDURA LATERAL MARCO LATERAL LATERAL FRAME	2177	73	12
22	2/4	1	FUNDO SUPERIOR FONDO TOP TOP FUND	2390	367	3
23	3/4	4	FUNDO FONDO BOTTOM	1774	597	3
24	4/4	8	PAINEL PANEL PANEL	1066	420	12
25	3/4	12	APLIQUE PORTA APLICARSE PUERTA APLY DOOR	1066	40	12
26	2/4	4	MOLDURA MENOR MARCO MENOR SMALLER FRAME	1066	100	25
27	2/4	4	MOLDURA FRONTAL PORTA MARCO PUERTA DELANTERA FRONT DOOR FRAME	2090	100	25
28	3/4	4	FRENTE DE GAVETA FRENTE DE CAJÓN FRONT OF DRAWER	551	170	12
29	1/4	8	LADO DE GAVETA LADO DEL CAJÓN SIDE OF DRAWER	350	122	12
30	3/4	4	FUNDO DE GAVETA RECORTADO FONDO DEL CAJÓN RECORTADO CROPPED DRAWER BOTTOM	521	361	3
31	1/4	4	RIPA DE TRÁS MALLA DETRÁS REAR LATH	534	122	12

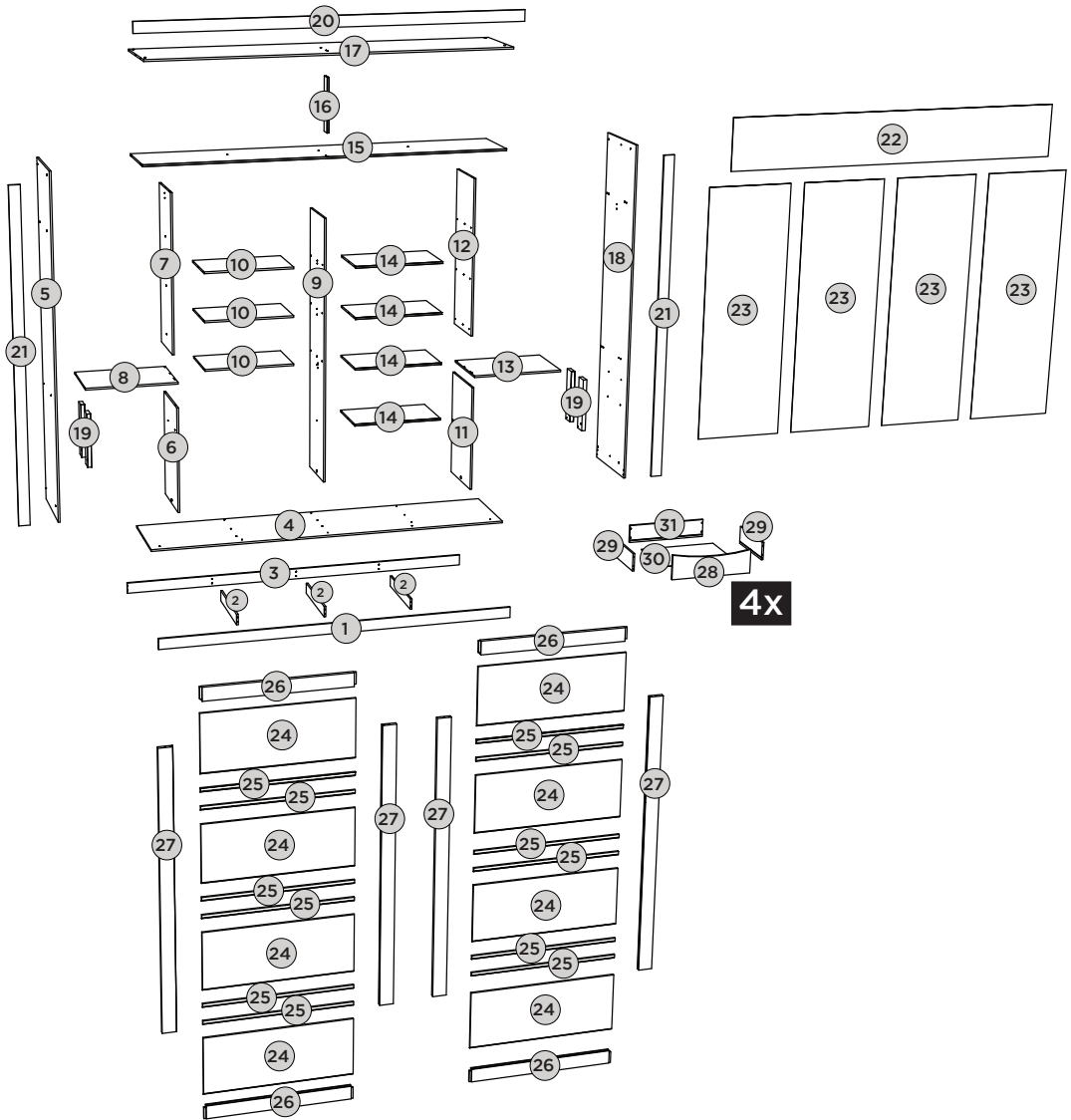



4x

PEÇAS REQUERIDAS

1	RODAPÉ FRONTAL	x1
2	TRAVESSA DO RODAPÉ	x3
3	RODAPÉ TRASEIRO	x1
16	RIPA DO MALEIRO	x1

ACESSÓRIOS REQUERIDOS

E		06
J		22
Q		06



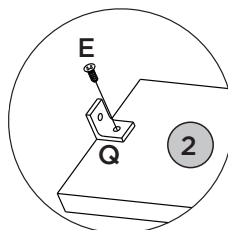
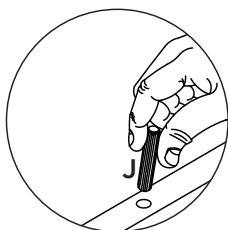
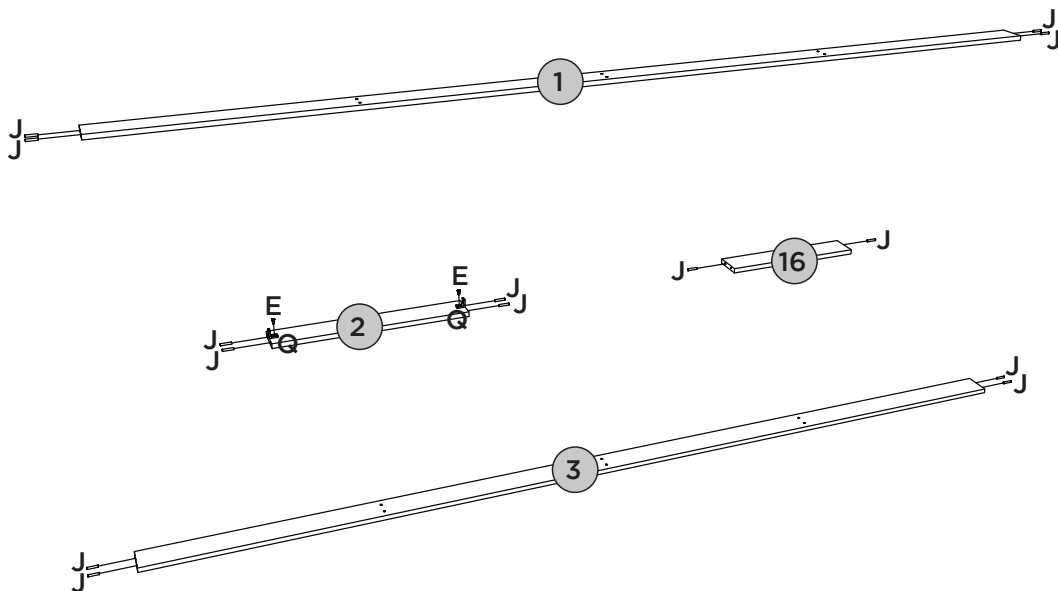
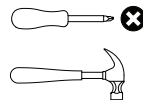

FERRAMENTAS NECESSÁRIAS



PEÇAS REQUERIDAS

4	BASE	x1
5	LATERAL ESQUERDA	x1
9	DIVISÃO CENTRAL	x1

ACESSÓRIOS REQUERIDOS

F		04
J		06
M		03
P		04
S		02

FERRAMENTAS NECESSÁRIAS

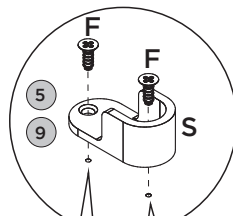
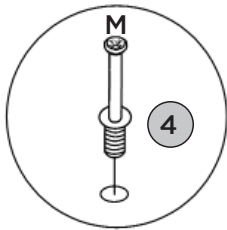
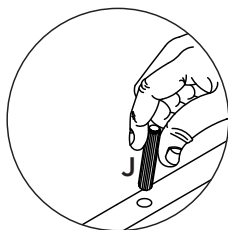
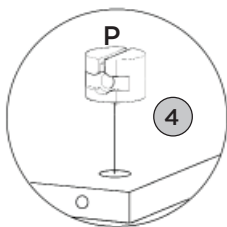
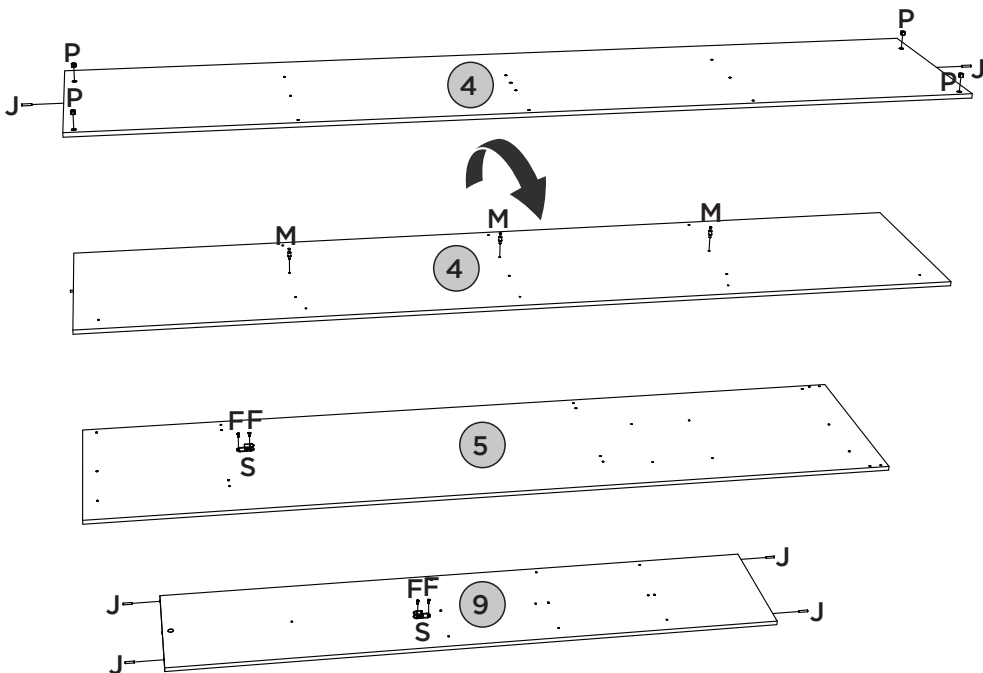
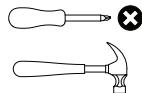





**Observe:
Furos
pré-marcados**

PEÇAS REQUERIDAS

6	DIVISÃO ESQUERDA	x1
7	DIVISÃO SUPERIOR ESQUERDA	x1
8=13	TAMPO DAS GAVETAS	x2
10=14	PRATELEIRA	x7
11	DIVISÃO DIREITA	x1

ACESSÓRIOS REQUERIDOS

F		13
J		44
S		02
V		03

FERRAMENTAS NECESSÁRIAS

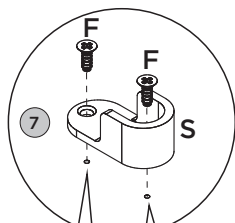
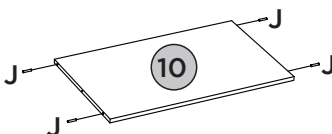
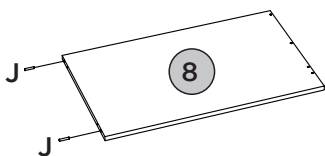
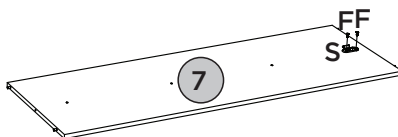
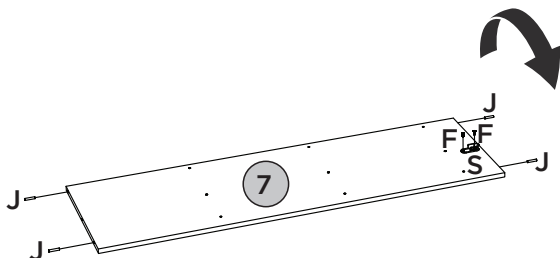
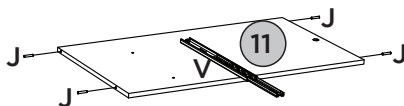
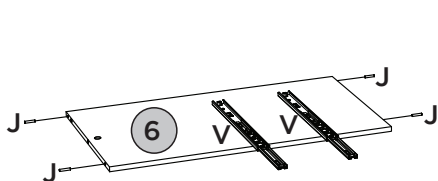
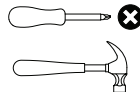



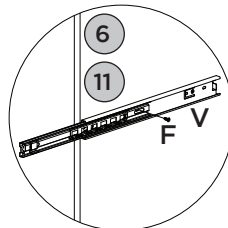
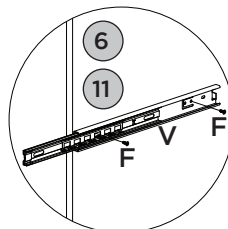
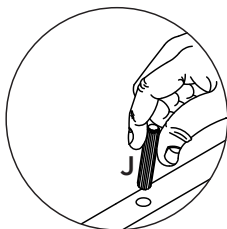

**Observe:
Furos
pré-marcados**



PEÇAS REQUERIDAS

12	DIVISÃO SUPERIOR DIREITA	x1
15	CHÃO DO MALEIRO	x1
17	TAMPO SUPERIOR	x1
18	LATERAL DIREITA	x1

ACESSÓRIOS REQUERIDOS

F		04
J		10
P		04
S		02

FERRAMENTAS NECESSÁRIAS

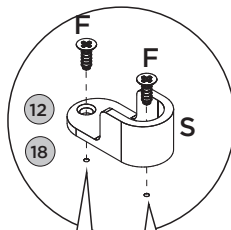
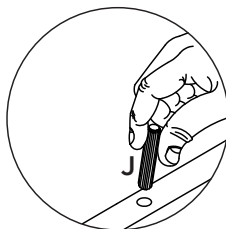
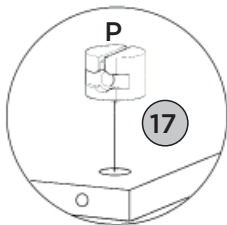
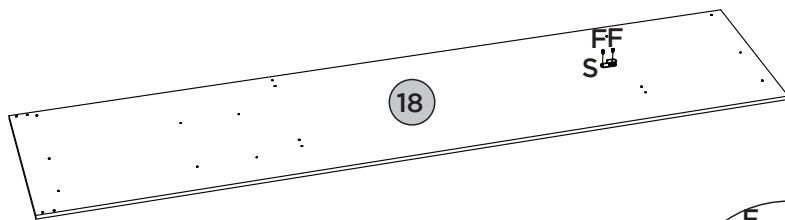
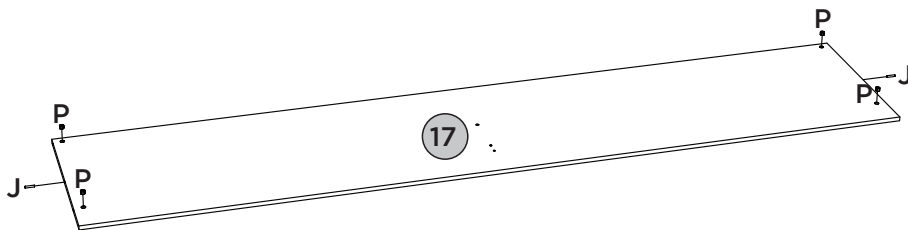
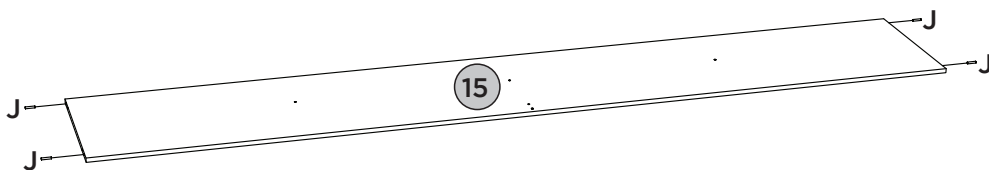
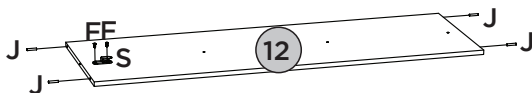
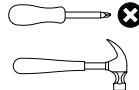

**Observe:
Furos
pré-marcados**

PASSO 5

ITM/D326-

PEÇAS REQUERIDAS

1	RODAPÉ FRONTAL	x1
2	TRAVESSA DO RODAPÉ	x3
3	RODAPÉ TRASEIRO	x1

ACESSÓRIOS REQUERIDOS

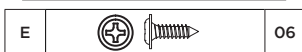



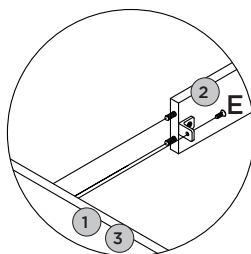
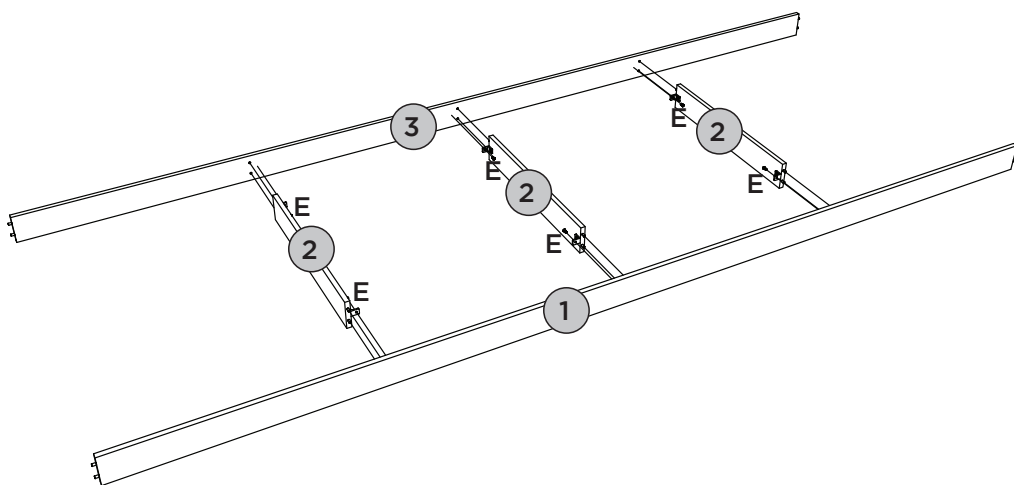
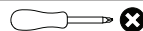

FERRAMENTAS NECESSÁRIAS



PEÇAS REQUERIDAS

4	BASE	x1
5	LATERAL ESQUERDA	x1
6	DIVISÃO ESQUERDA	x1

ACESSÓRIOS REQUERIDOS

A		02
E		39
N		01
Q		06
U		09

FERRAMENTAS NECESSÁRIAS

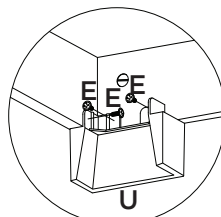
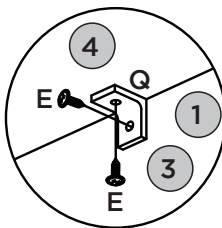
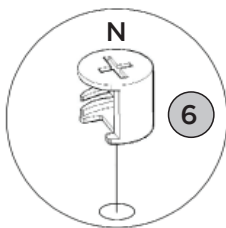
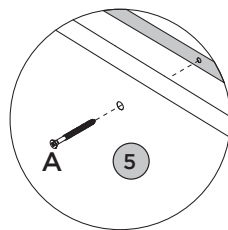
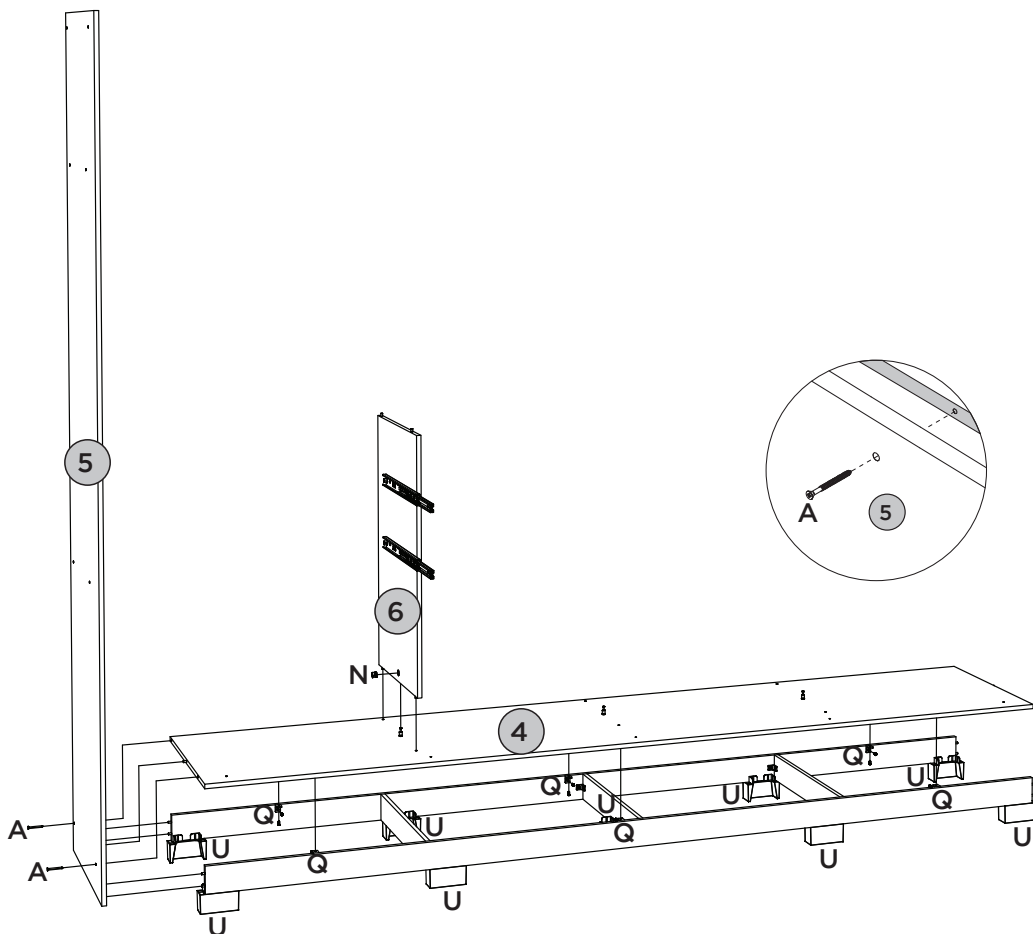
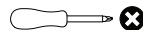

PEÇAS REQUERIDAS

7	DIVISÃO SUPERIOR ESQUERDA	x1
8	TAMPO DAS GAVETAS	x1

ACESSÓRIOS REQUERIDOS

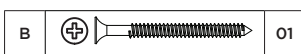

FERRAMENTAS NECESSÁRIAS

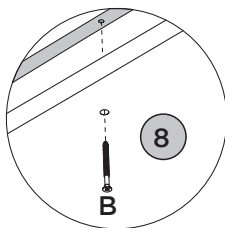
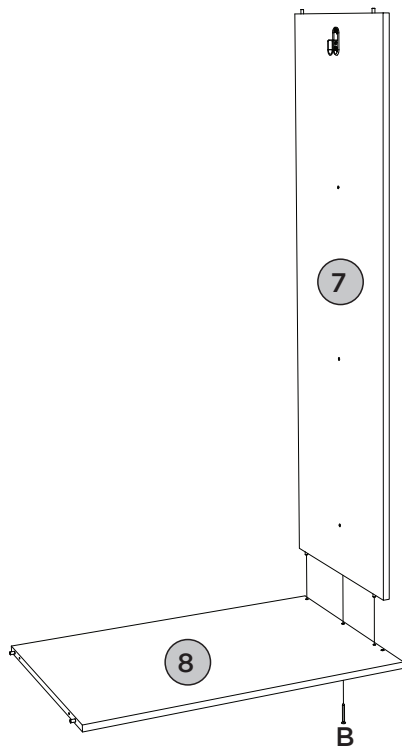
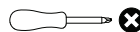





PASSO 8

ITM/D326-

PEÇAS REQUERIDAS

9	DIVISÃO CENTRAL	x1
10	PRATELEIRA	x3

ACESSÓRIOS REQUERIDOS

B		08
E		02
N		01
Q		01

FERRAMENTAS NECESSÁRIAS

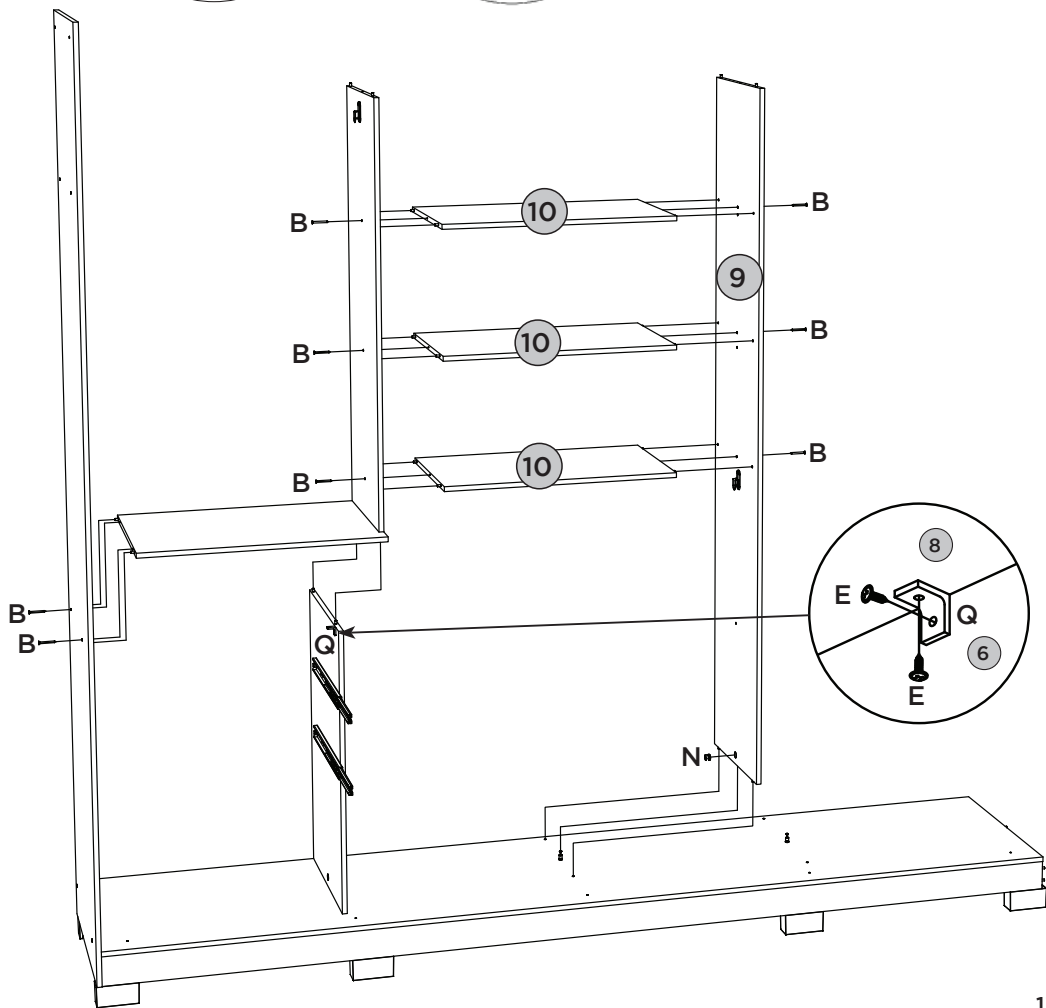
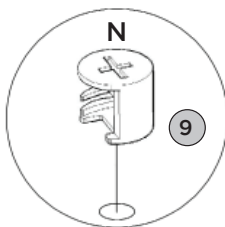
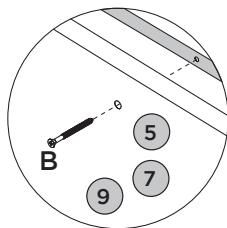
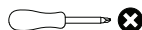





PASSO 9

ITM/D326-

PEÇAS REQUERIDAS

11	DIVISÃO DIREITA	x1
12	DIVISÃO SUPERIOR DIREITA	x1
13=8	TAMPO DAS GAVETAS	x1
14=10	PRATELEIRA	x4

ACESSÓRIOS REQUERIDOS

B		09
E		02
N		01
Q		01

FERRAMENTAS NECESSÁRIAS

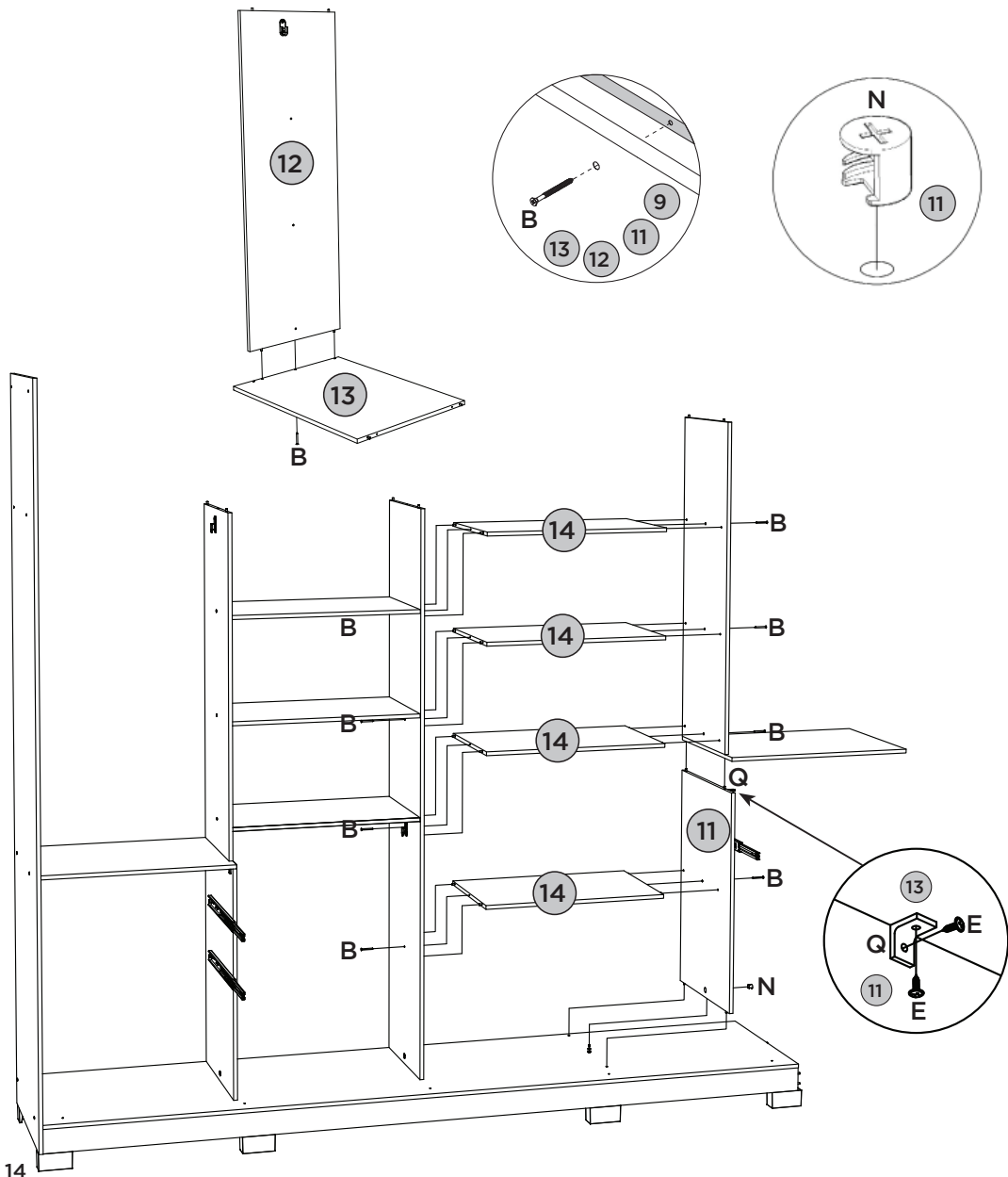

PEÇAS REQUERIDAS

15	CHÃO DO MALEIRO	x1
16	RIPA DO MALEIRO	x1

ACESSÓRIOS REQUERIDOS

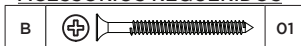

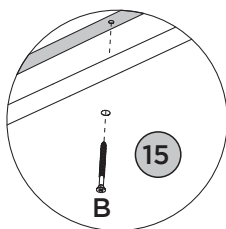
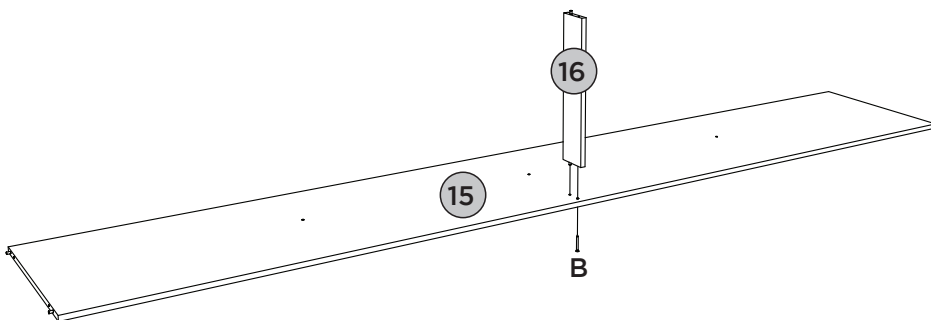
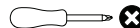

FERRAMENTAS NECESSÁRIAS



PEÇAS REQUERIDAS

17	TAMPO SUPERIOR	x1
18	LATERAL DIREITA	x1
19	RIPA LATERAL	x4

ACESSÓRIOS REQUERIDOS

A		06
B		10
C		08



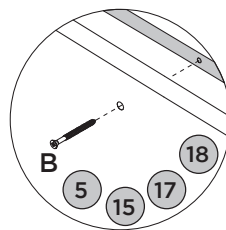
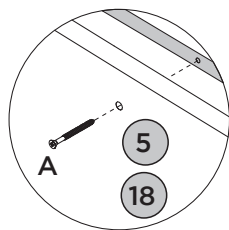
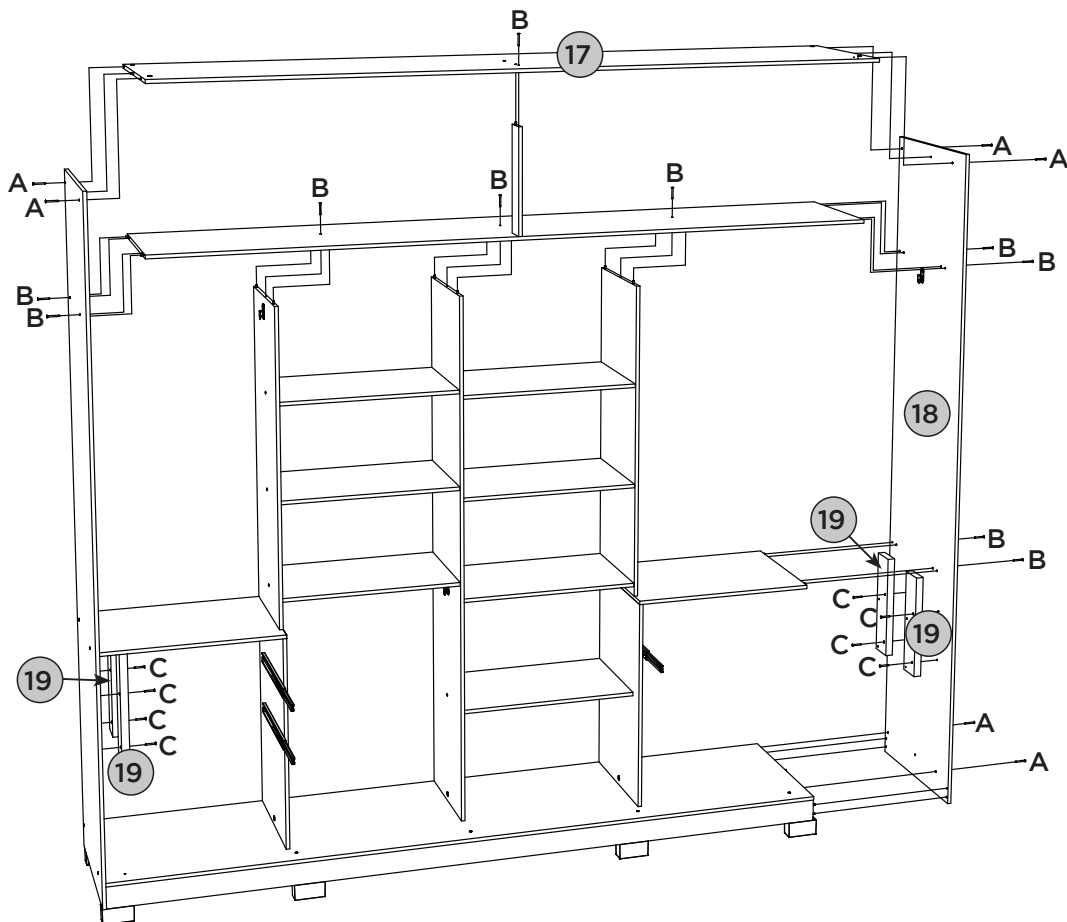
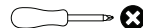



FERRAMENTAS NECESSÁRIAS



PEÇAS REQUERIDAS

20	MOLDURA SUPERIOR	x1
21	MOLDURA LATERAL	x2
22	FUNDO SUPERIOR	x1
23	FUNDO	x4

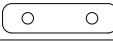
ACESSÓRIOS REQUERIDOS

E		26
F		04
K		240
L		74
R		02
T		13

FERRAMENTAS NECESSÁRIAS

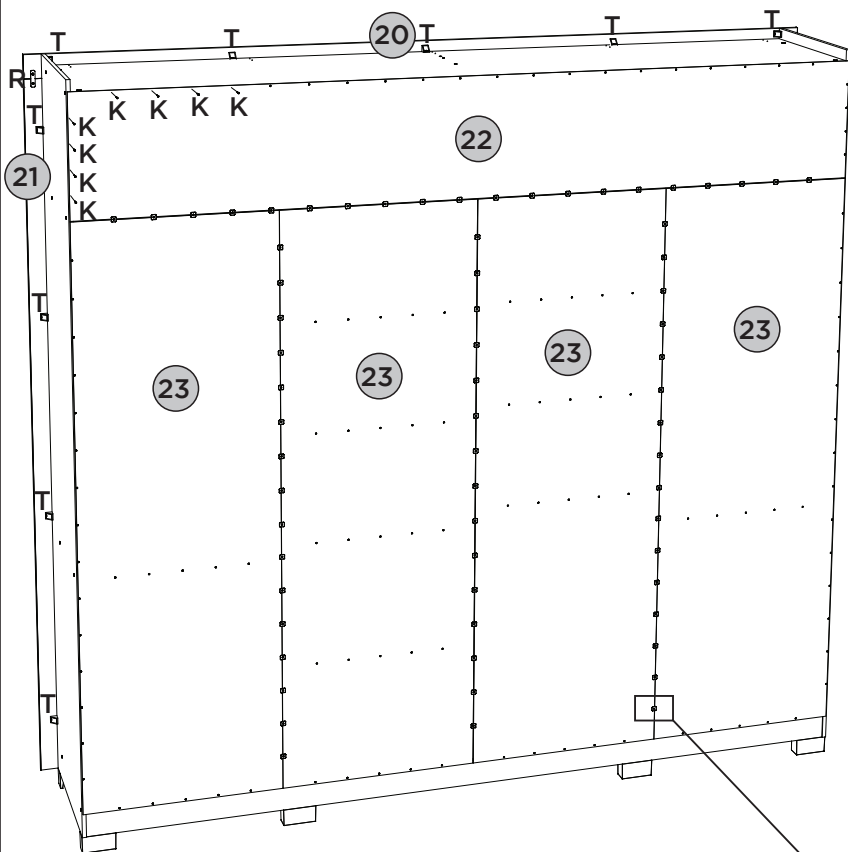
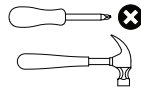





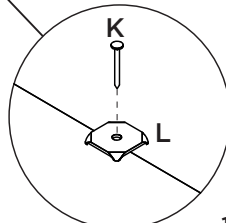
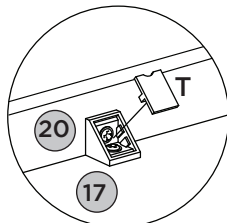
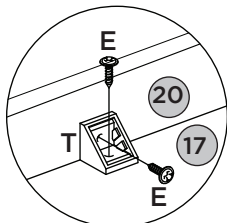
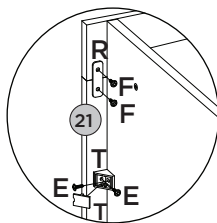

Fixar os pregos a uma distância de 100mm de um para outro.

Fijar las uñas a un distancia de 100mm uno a otro.

Fix the nails at a distance of 100mm from one to the other



ACESSÓRIOS REQUERIDOS

F		26	Z		01
V		04	AA		01
W		03	AB		01



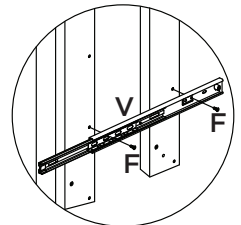
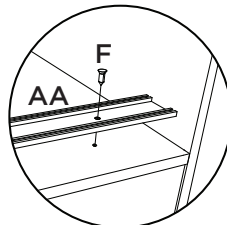
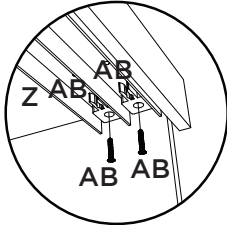
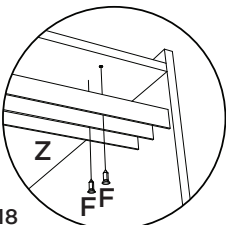
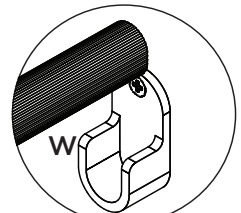
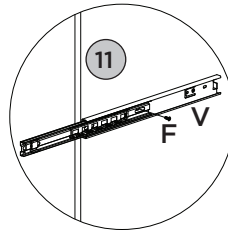
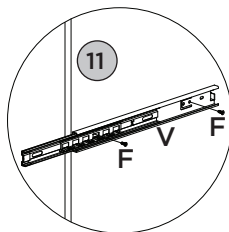
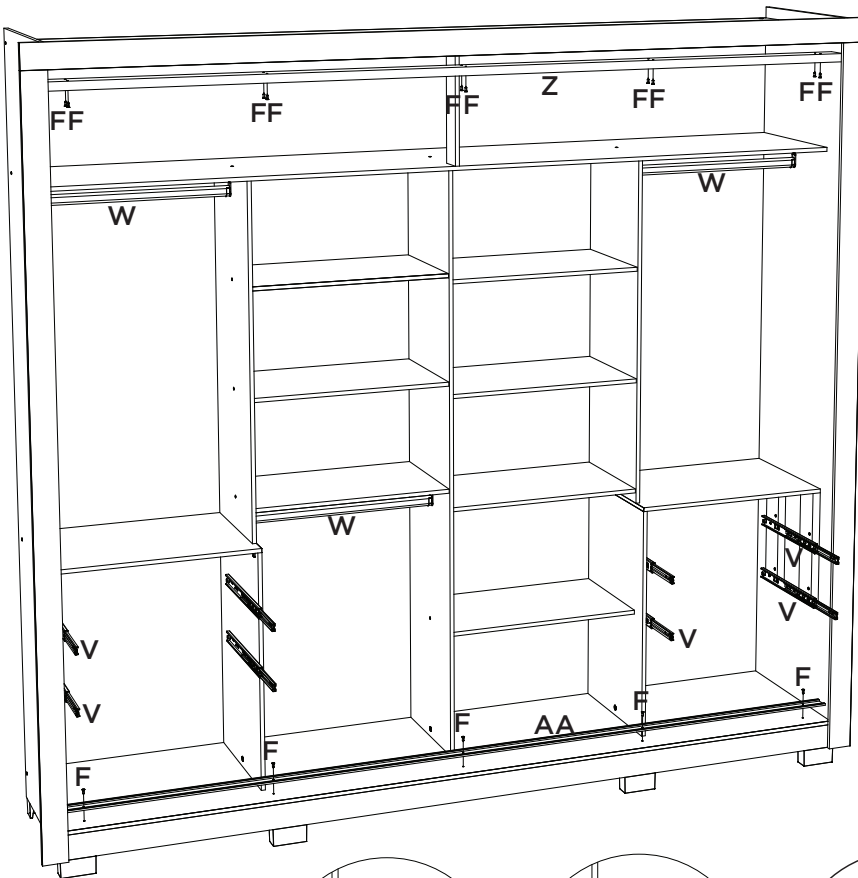
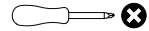

FERRAMENTAS NECESSÁRIAS





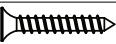

PEÇAS REQUERIDAS

24	PAINEL	x8
25	APLIQUE PORTA	x12
26	MOLDURA MENOR	x4
27	MOLDURA FRONTAL PORTA	x4

ACESSÓRIOS REQUERIDOS

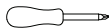
F		72
G		36
H		04
R		36
X		02

FERRAMENTAS NECESSÁRIAS

		
Y		01
AB		01

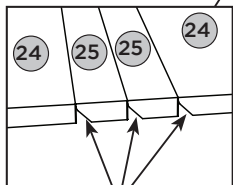
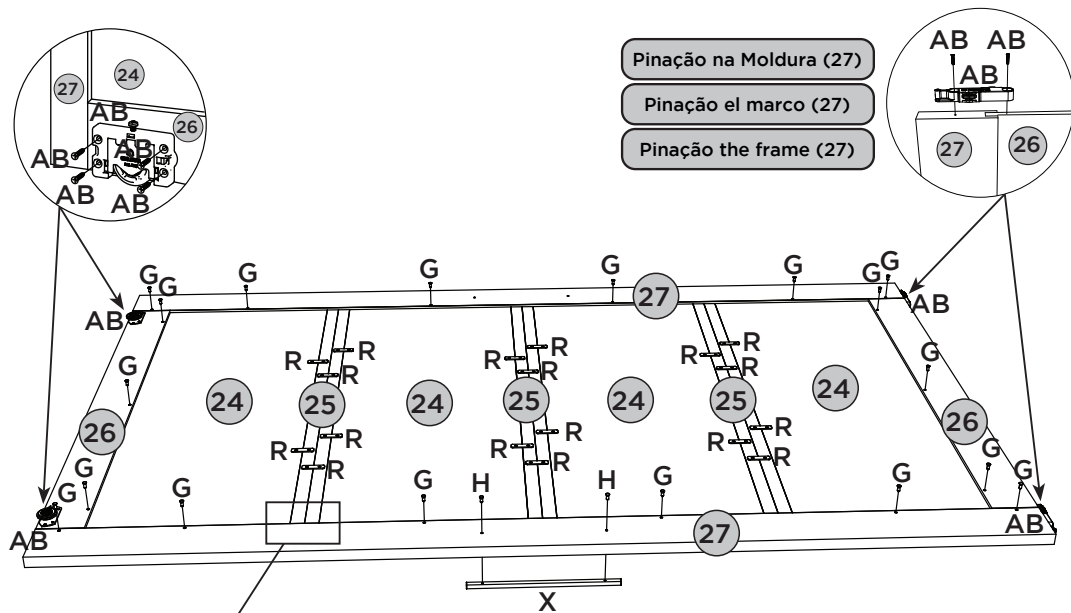

Detalle de las piezas voltadas abajo e frente do produto.

Detalle de las piezas boca abajo y frontal del producto.

Detail of the pieces facing down and front of the product.

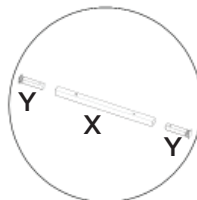
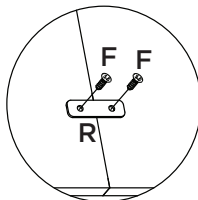

PEÇAS REQUERIDAS

24	PAINEL	x8
26	MOLDURA MENOR	x4
27	MOLDURA FRONTAL PORTA	x4

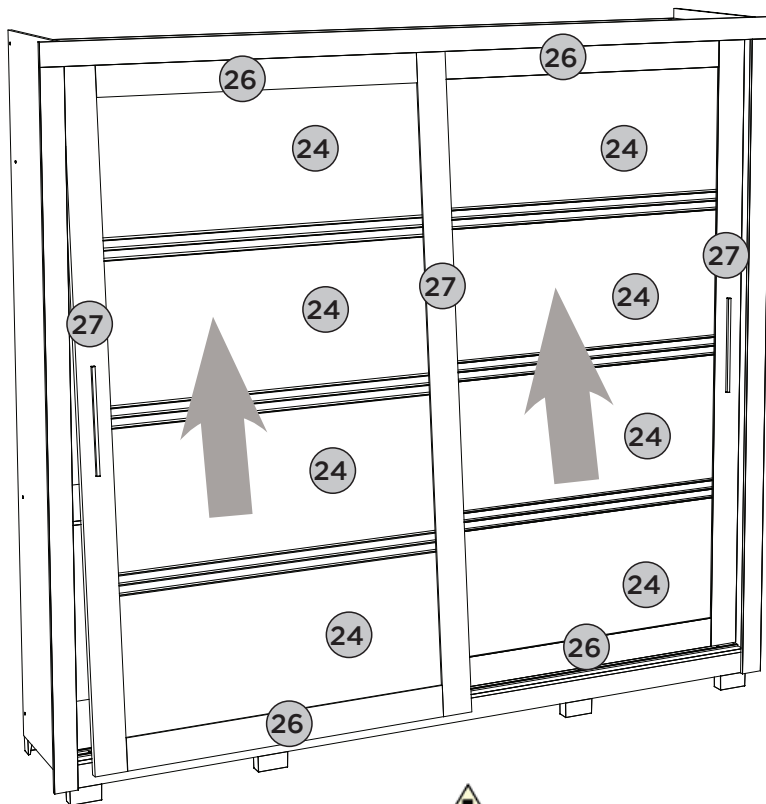

Para a colocação das portas nos trilhos encaixe primeira a porta no trilho de PVC superior (Z) e em seguida no trilho de alumínio inferior (AA).

Para la colocación de las puertas en la pista instalación de la puerta en la primera banda superior PVC (Z) y luego el riel de aluminio inferior (AA).

For placing the doors on the rails fitting the door on the PVC rail first (Z) and then on the lower aluminum rail (AA).



PASSO 16

ITM/D326-

PEÇAS REQUERIDAS

29	LADO DE GAVETA	x8
----	----------------	----

ACESSÓRIOS REQUERIDOS

J		32
AC		

FERRAMENTAS NECESSÁRIAS

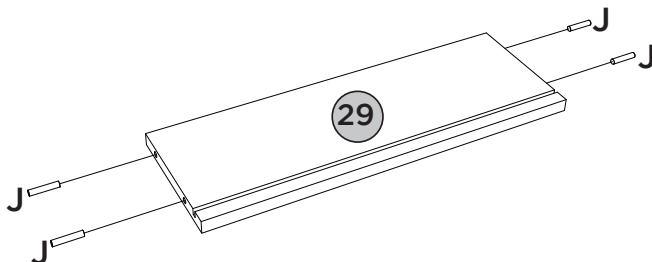
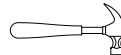



PASSO 17

PEÇAS REQUERIDAS

28	FRENTE DE GAVETA	x4
29	LADO DE GAVETA	x8
30	FUNDO DE GAVETA RECORTADO	x4

ACESSÓRIOS REQUERIDOS

F		16
Q		08
AC		

FERRAMENTAS NECESSÁRIAS

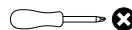

4x

1º

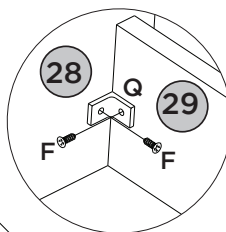
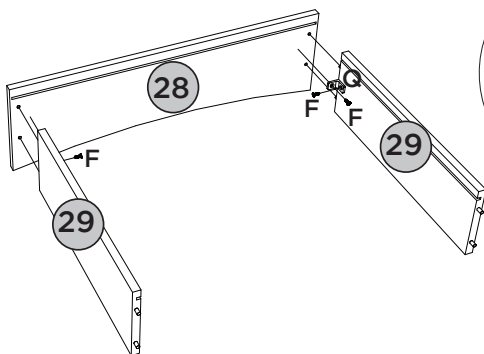

4x



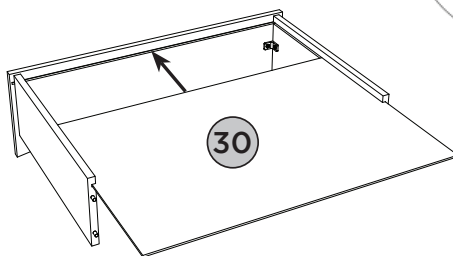
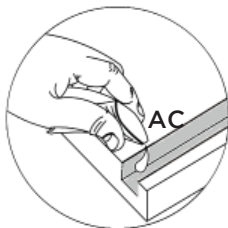







2º

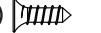

PEÇAS REQUERIDAS

31	RIPA DE TRÁS	x4
----	--------------	----

ACESSÓRIOS REQUERIDOS

D			08
F			24
I			08
O			08
V			04
AC			

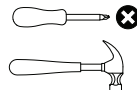
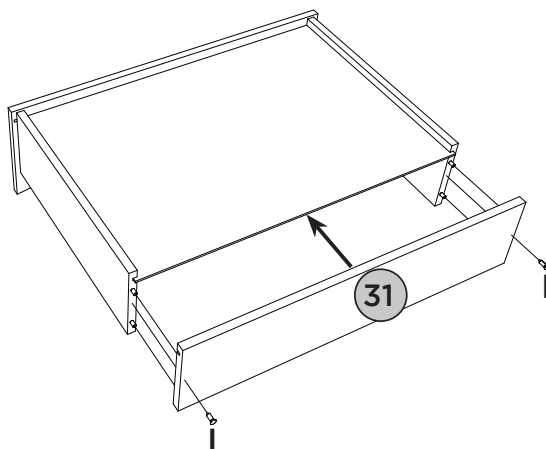
FERRAMENTAS NECESSÁRIAS

4x
3º

4x
4º

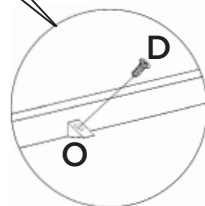
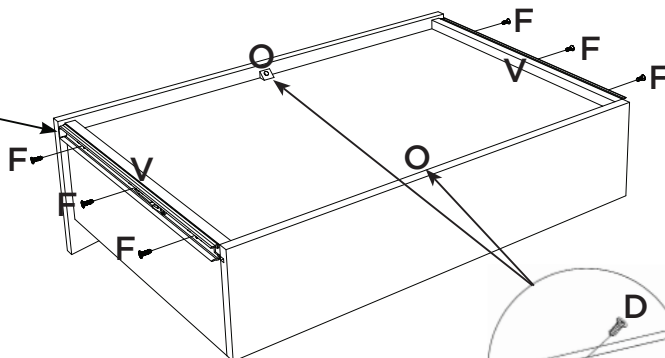

Deixar 3mm de distância da frente de gaveta.

Deje una separación de 3mm del frente del cajón.

Leave 3mm away from the front of the drawer.



ACESSÓRIOS REQUERIDOS

AD		32
AE		06
AF		03
AG	HENN	01

Pesos máximos recomendados com carga distribuída
 Peso máximo recomendado con la carga distribuida
 Recommended maximum weight with distributed load.

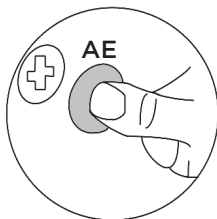
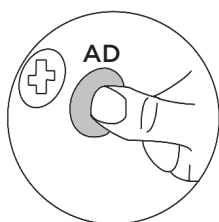
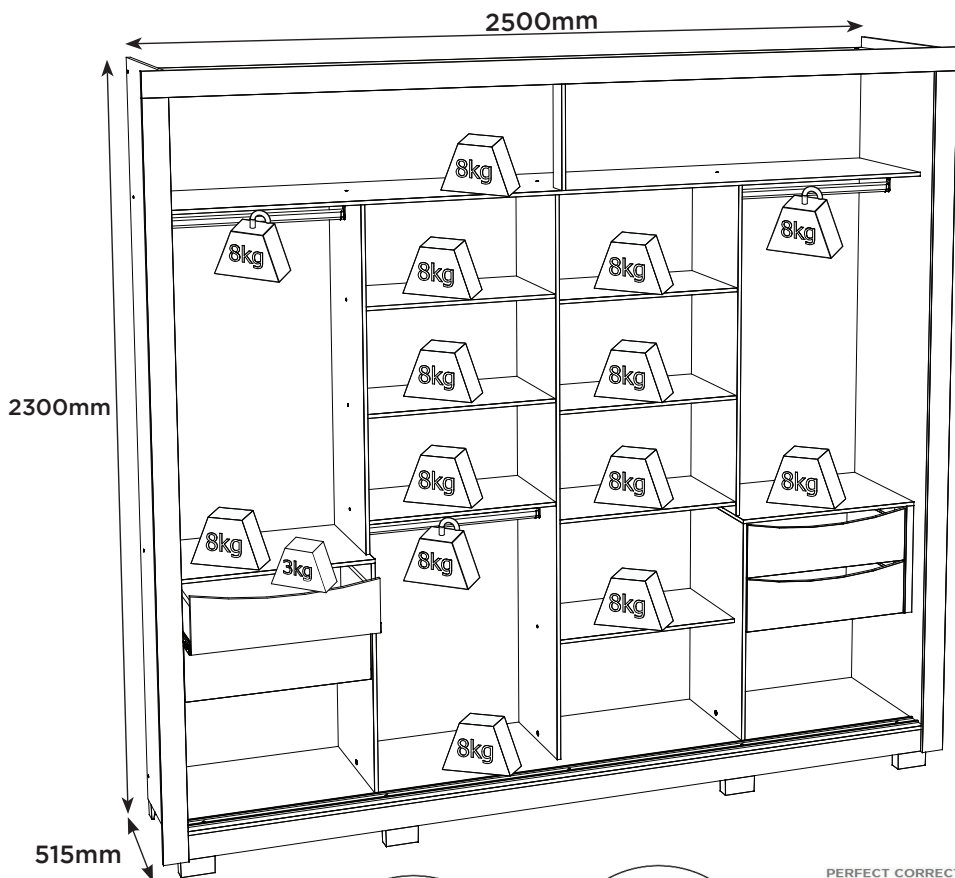

PERFECT CORRECTION
 CORRECCIÓN PERFECTA

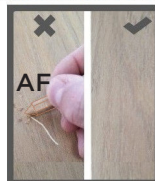

Produto Concluído
Producto terminado
Finished Product

