



















LISTA DE PEÇAS

Nº PC	DESCRIÇÃO	Medidas	Qtde
1160	Lateral Es. Dir. 1161	1994 x 0,335	02
1162	Frente gaveta	0,530 x 0,160	02
1165	Prateleira nicho	1460 x 0,250	01
1163	Base maleiro	2012 x 0,335	01
1157	Rodaforro	2012 x 0,100	01
1163	Chapéu cima	2012 x 0,335	01
1171	Fundos gavetas	0,510 x 0,327	04
1167	Travessa	1460 x 0,100	01
1168	Prateleira criado	0,540 x 0,250	01
1164	Divisão aerio	0,380 x 0,335	01
1170	Divisão criado	1490 x 0,335	01
1166	Divisão do nicho	0,340 x 0,250	01
1169	Prateleira fixa	0,540 x 0,335	01
1159	Porta maleiro	0,395 x 0,503	04
1158	União entre roup.	1994 x 0,100	01
122	Lateral gaveta	0,320 x 0,85	04
1175	Trazeira gaveta	0,490 x 0,70	02
1156	Rodape criado	0,540 x 0,100	01
1173	costa aério	1030 x 0,400	01
1174	costa gavetas	0,395 x 0,555	01
1172	costa nicho	2030 x 0,353	03

Acessórios		Qtd.	Acessórios		Qtd.
Parafuso 3,5 x 12		60	Cantoneira de Gav. e chapéu		08
Corrediça metálica 2461		04	Fixador costas		10
Parafuso 3,5 x 40		41	Cantoneira fixar união roup.		05
Parafuso 3,5 x 30 puxador		12	Cavilha 6 x 30		08
Prego 10 x 10		80	Cola		01
Prego p/traz gav. 13 x 15		08	Parafuso 3,5 x 25 unir rp.		05
Sapata plástica		06			
Puxador 4-13		06	Perfil i 540 mm		01
Dobradiça		08	Perfil i 2030 mm		01
Calço Dobradiça		08	Ferragem F 58810		01

Montando a cabeceira com o roupeiro ex.

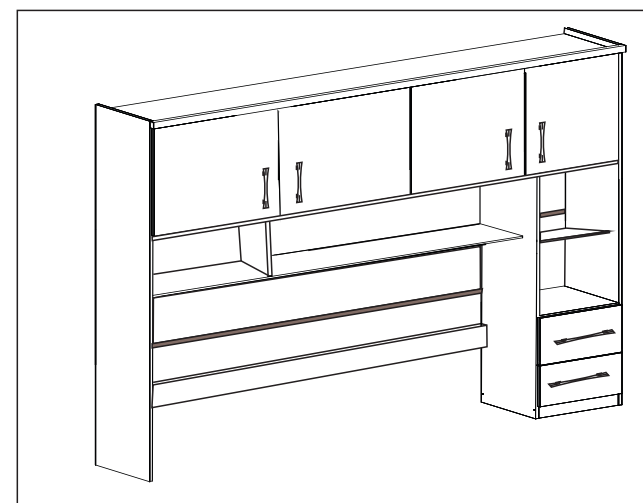
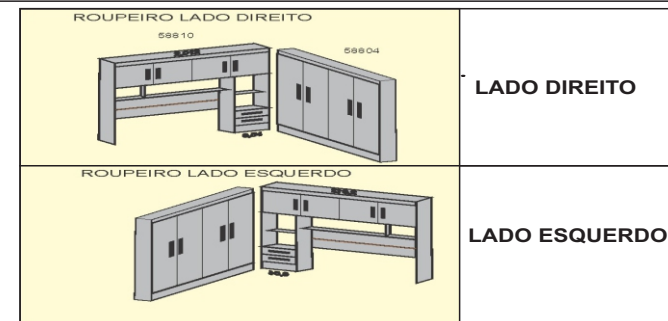
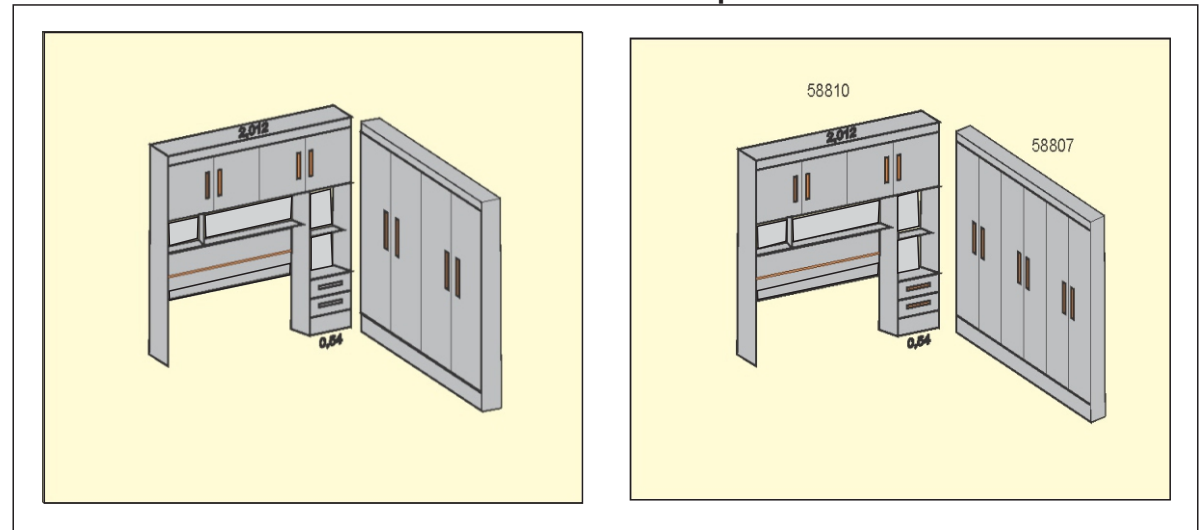

MARTELO
Martillo
Hammer

CHAVE
Destornillador
Screwdriver

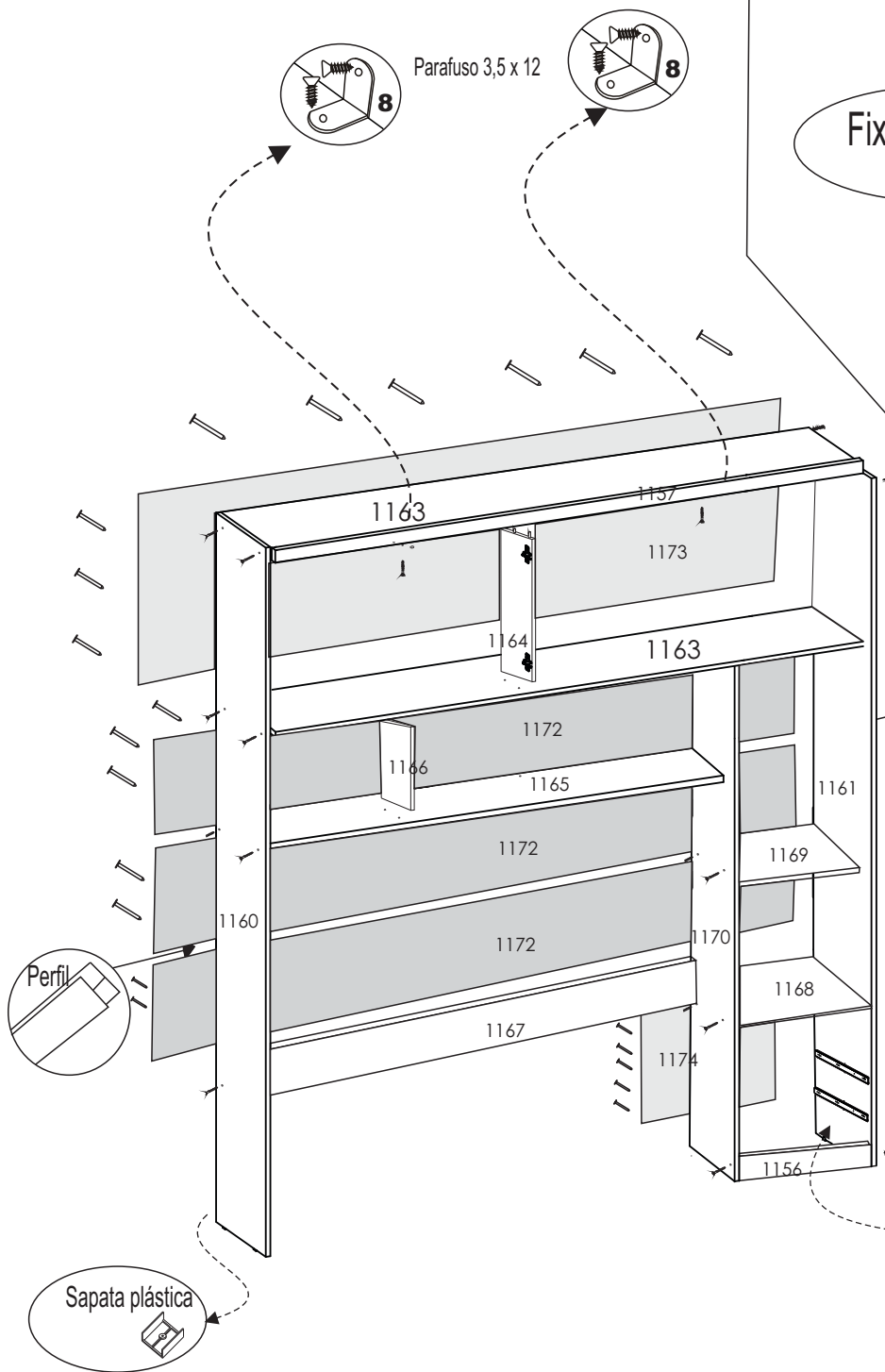

Fixador costas

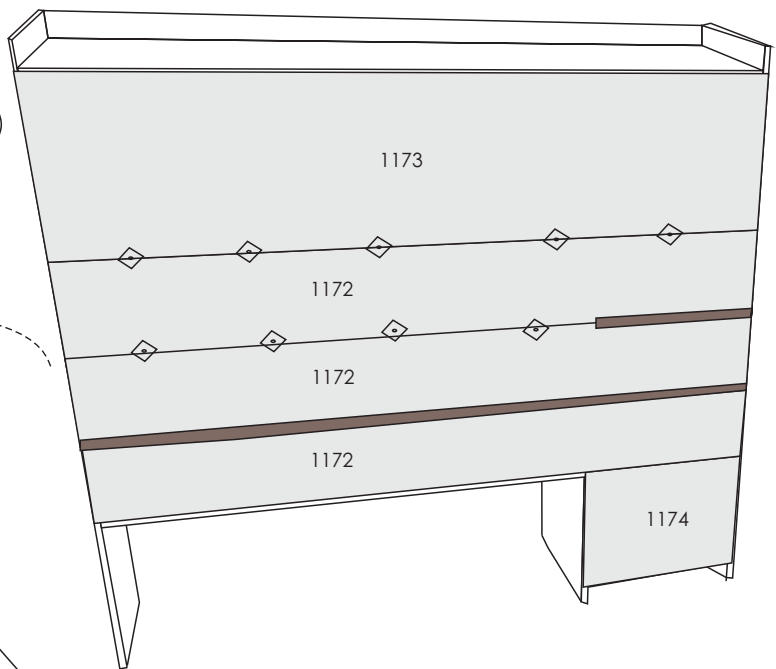

Perfil

Perfil

Parafuso 3,5 x 40

Corrediza metalica

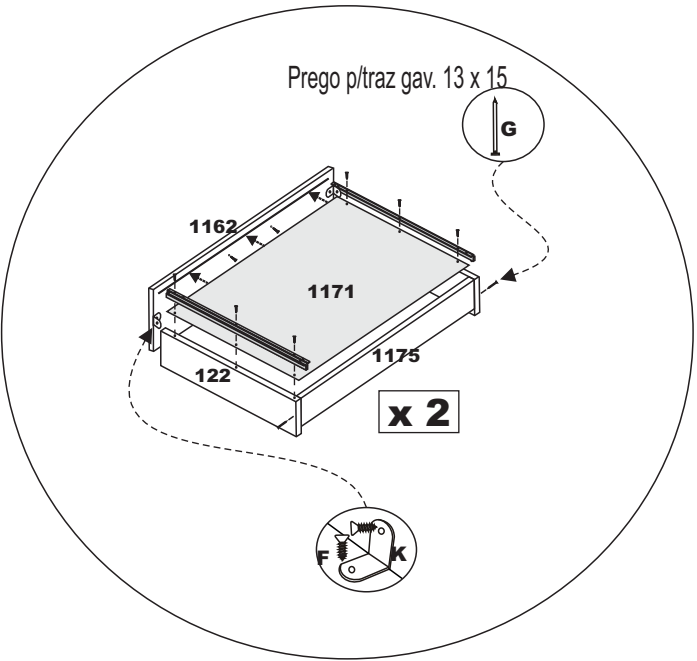

Prego p/traz gav. 13 x 15

x 2

Montando a cabeceira com o roupeiro L.D ou L.E

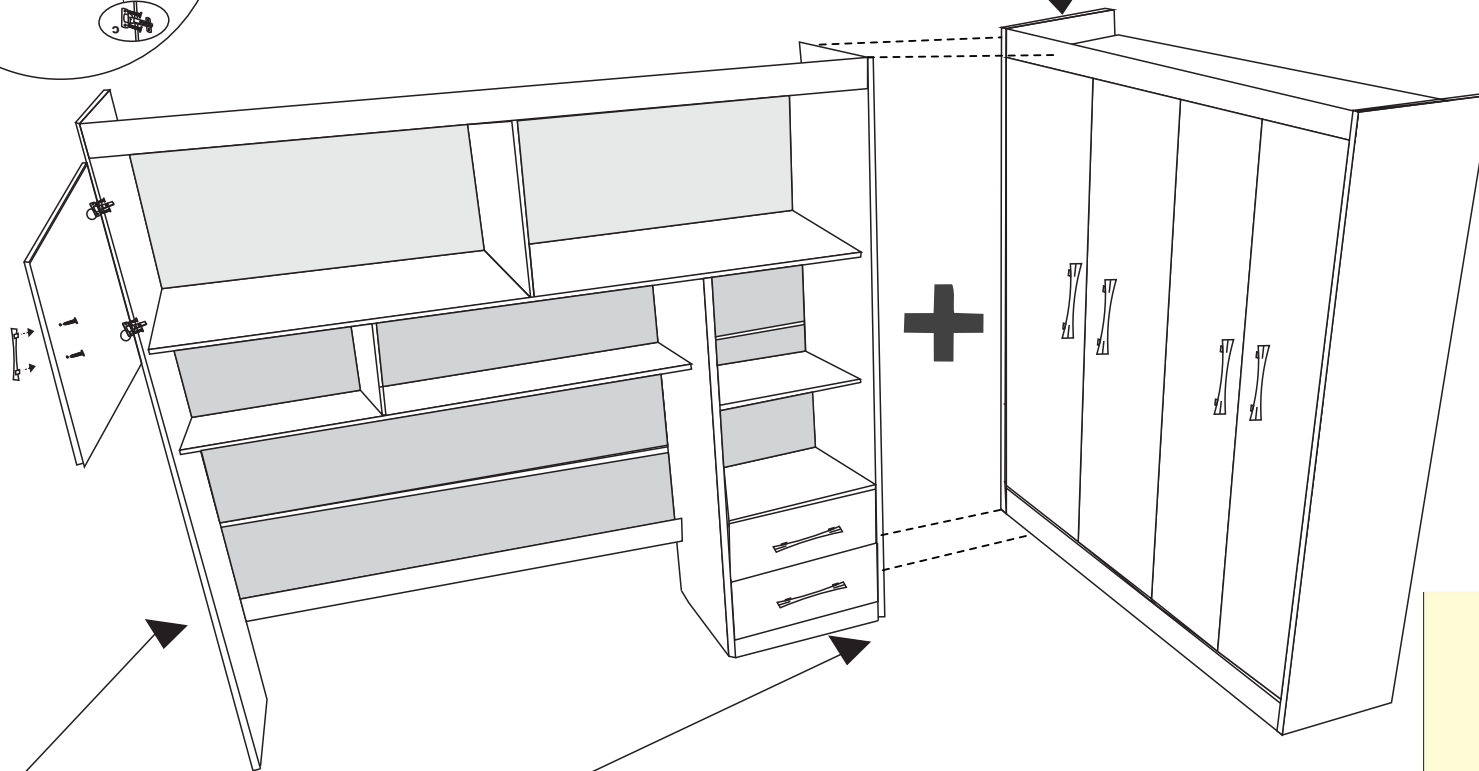
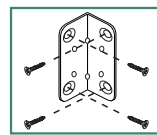
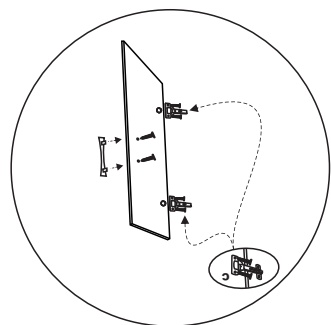

Roupeiro pode ser montada ambos L.D ou L.E

Roupeiro pode ser montada ambos L.D ou L.E

Lateral Direita esta abaixo topo risco preto
Lateral Esquerda esta abaixo topo risco vermelho

obs> Lateral Direita pode ser colocada local da Esquerda para mudar criado lado.

ROUPEIRO LADO DIREITO

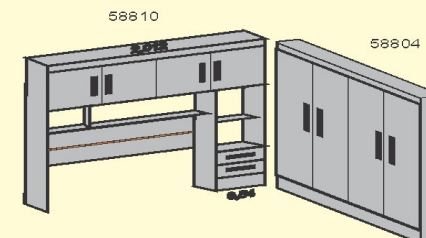

ROUPEIRO LADO ESQUERDO

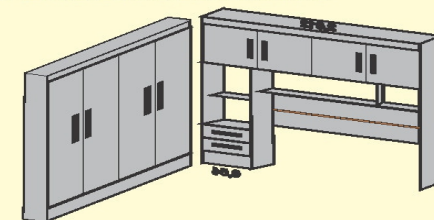

Fixe a cantoneira na pç 1158 com a lateral do roupeiro, após encosta roupeiro na lateral da cabeceira e fixa com parafusos 3,5 x 25 como mostra desenho.

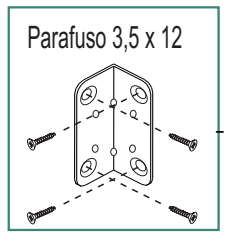

EX.

Lateral rp

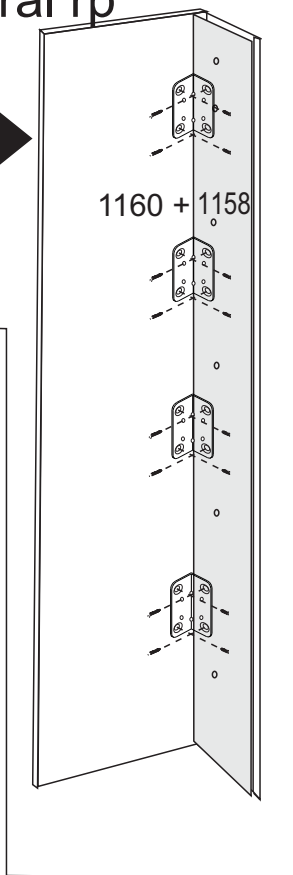

Alinhar peça 1158 com parafusos lateral da cabeceira



Parafuso 3,5 x 25 unir rp.

