

Ref. RG129

Roupeiro
Ropero
Closet
MONTECARLO

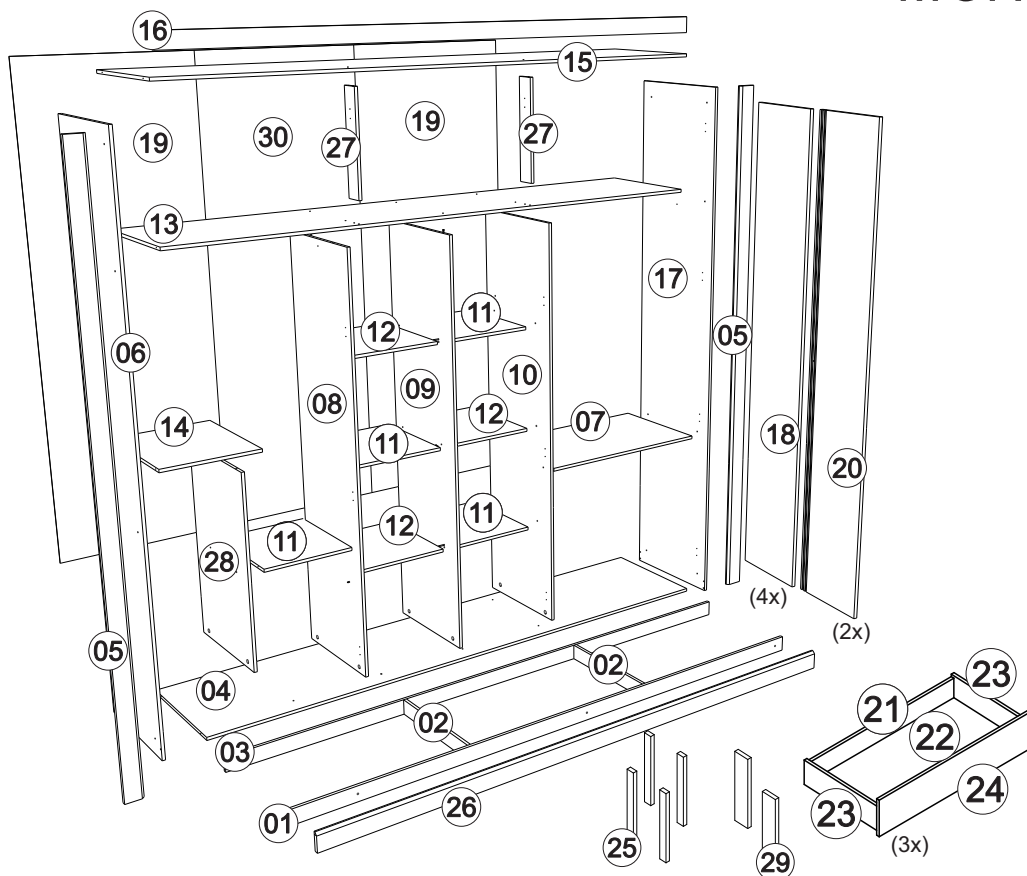

Nº	CÓDIGO CODE ASSISTENCIA ATTENDANCE	NOME DA PEÇA/DESCRIPCIÓN PIEZAS/DESCRIPTION PARTS	MEDIDAS (mm) MEASURES (mm)	QTD.	MARROCOS OFF WHITE
01	RG129.30.00	Rodapé frontal/Zócalo delantero/Front panel	2188x58x12	01	265622
02	RG129.31.00	Rodapé interno/ Zócalo interno/Internal baseboard	429x58x12	02	259791
03	RG129.32.00	Rodapé traseiro/Zócalo de atrás/Border back	2188x58x12	01	259773
04	RG129.01.00	Base inferior/Base inferior/Shelf	2188x453x12	01	262798
05	RG129.11.00	Ripa envoltorio lateral/Envoltorio lateral/side wrap slat	2170x70x15	02	262796
06	RG129.18.00	Lateral externa esquerda/Lateral izquierda/Inner side	2170x453x12	01	262950
07	RG129.04.00	Base sobre gaveta/Base sob gaveta/Shelf	724x434x12	01	262826
08	RG129.19.02	Lateral interna central/Lateral int. central/Inner side	1630x434x12	01	262829
09	RG129.19.01	Lateral interna direita/Lateral int. derecha/Inner side	1630x434x12	01	262828
10	RG129.19.00	Lateral interna esquerda/Lateral int. izquierda/Inner side	1630x434x12	01	262801
11	RG129.02.00	Base interna/Base interna/Shelf	387x352x12	04	259778
12	RG109.27.00	Prateleira interna/Prateleira interna/Shelf	387x352x12	03	259789
13	RG129.03.00	Base maleiro menor/Base maletero/Shelf	2188x434x12	01	262799
14	RG129.02.01	Base interna/Base interna/Shelf	434x372x12	01	260107
15	RG129.05.00	Base superior/Base superior/Shelf	2188x453x12	01	262800
16	RG129.07.00	Chapeu/Chapeu/Hat	2158x70x15	01	262795
17	RG129.17.00	Lateral interna direita/Lateral/Inner side	2170x453x12	01	262949
18	RG129.25.00	Porta/Puerta/Door	2022x360x15	02	262778
19	RG129.13.00	Forro/Revés/Bottom	2042x736x2,5	02	259765
20	RG129.25.01	Porta/Puerta/Door	2022x353x15	04	262942
21	RG129.29.00	RipaTraseiro de gaveta/Trasero cajón/Drawer back	620x80x12	03	259790
22	RG129.34.00	Forro gaveta/Fondo cajón/Bottom	644x355x2,5	03	259767
23	RG129.15.00	Lateral gaveta/Lateral cajón/Drawer side	350x100x12	06	259785
24	RG129.14.00	Frente gaveta/Frente cajón/Drawer front	652x142x12	03	259784
25	RG129.09.00	Distanciador/Espaciador/Spacer	491x54x22	04	262169
26	RG129.11.01	Ripa envolt. front. /listón envolvente frontal/lower upper wrap slat	2158x70x15	01	262797
27	RG129.06.00	Ripa batente/Parada de listones/Stop slat	388x70x12	02	262827
28	RG129.19.03	Lateral interna menor/Lateral int. menor/Inner side	750x434x12	01	262802
29	RG129.09.01	Distanciador/Espaciador/Spacer	491x70x12	02	265623
30	RG129.13.01	Forro/Revés/Bottom	2042x728x2,5	01	259766

Ferragens/Herrajes/Hardware

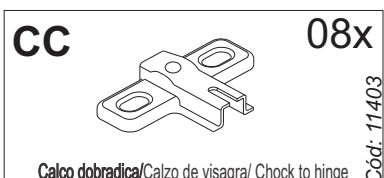
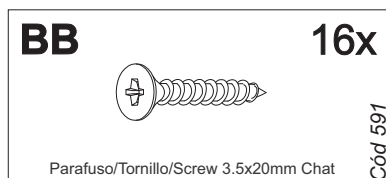
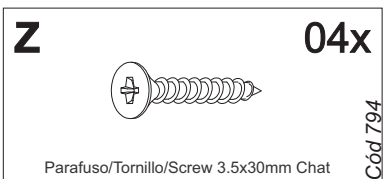
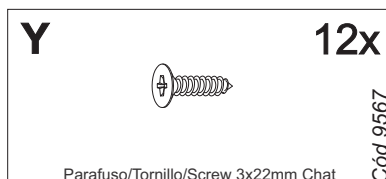
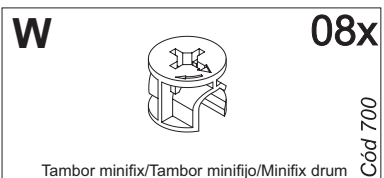
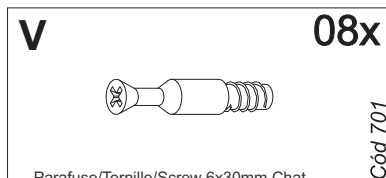
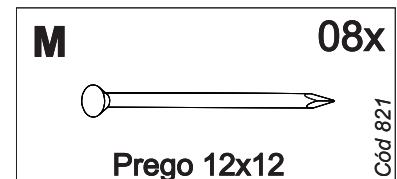
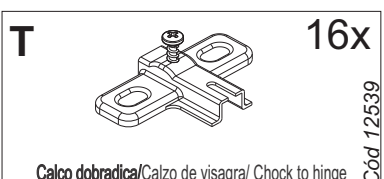
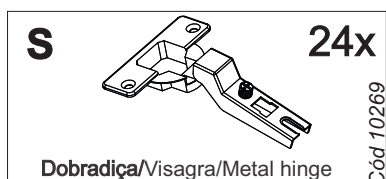
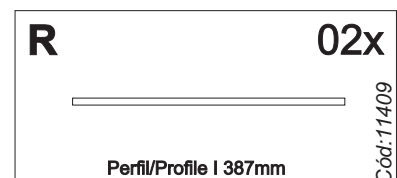
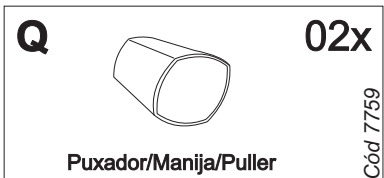
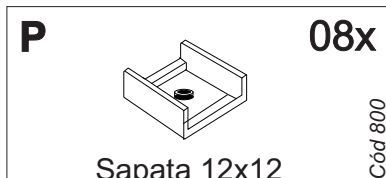
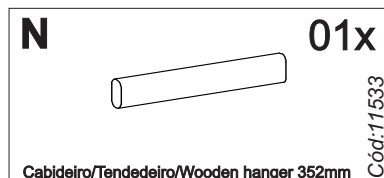
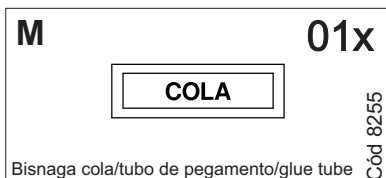
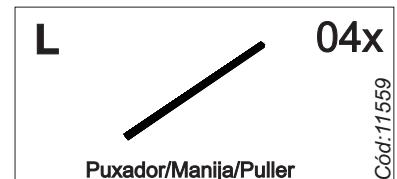
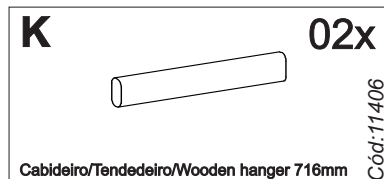
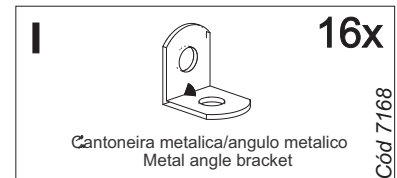
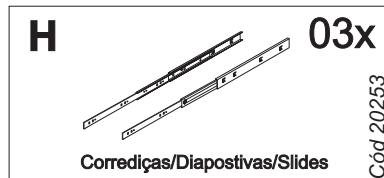
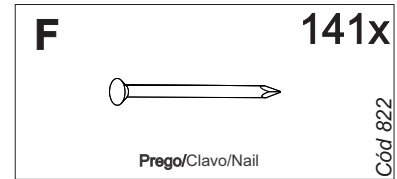
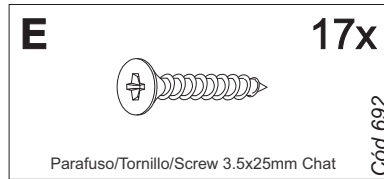
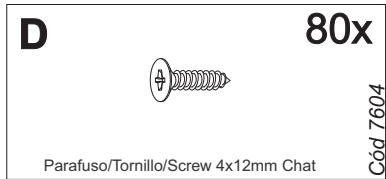
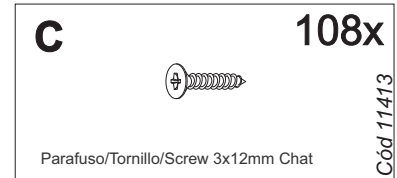
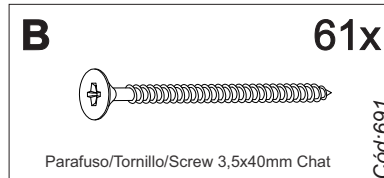
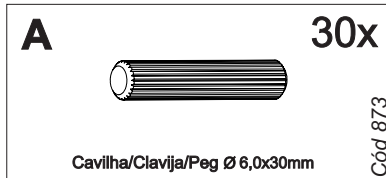

Pré-Montagem/Preparación Piezas/ Pre-assembly

Obs: Para as laterais externas são utilizados distanciadores de calço plástico, antes dos calços, fixando os dois com o parafuso 3,5x20.

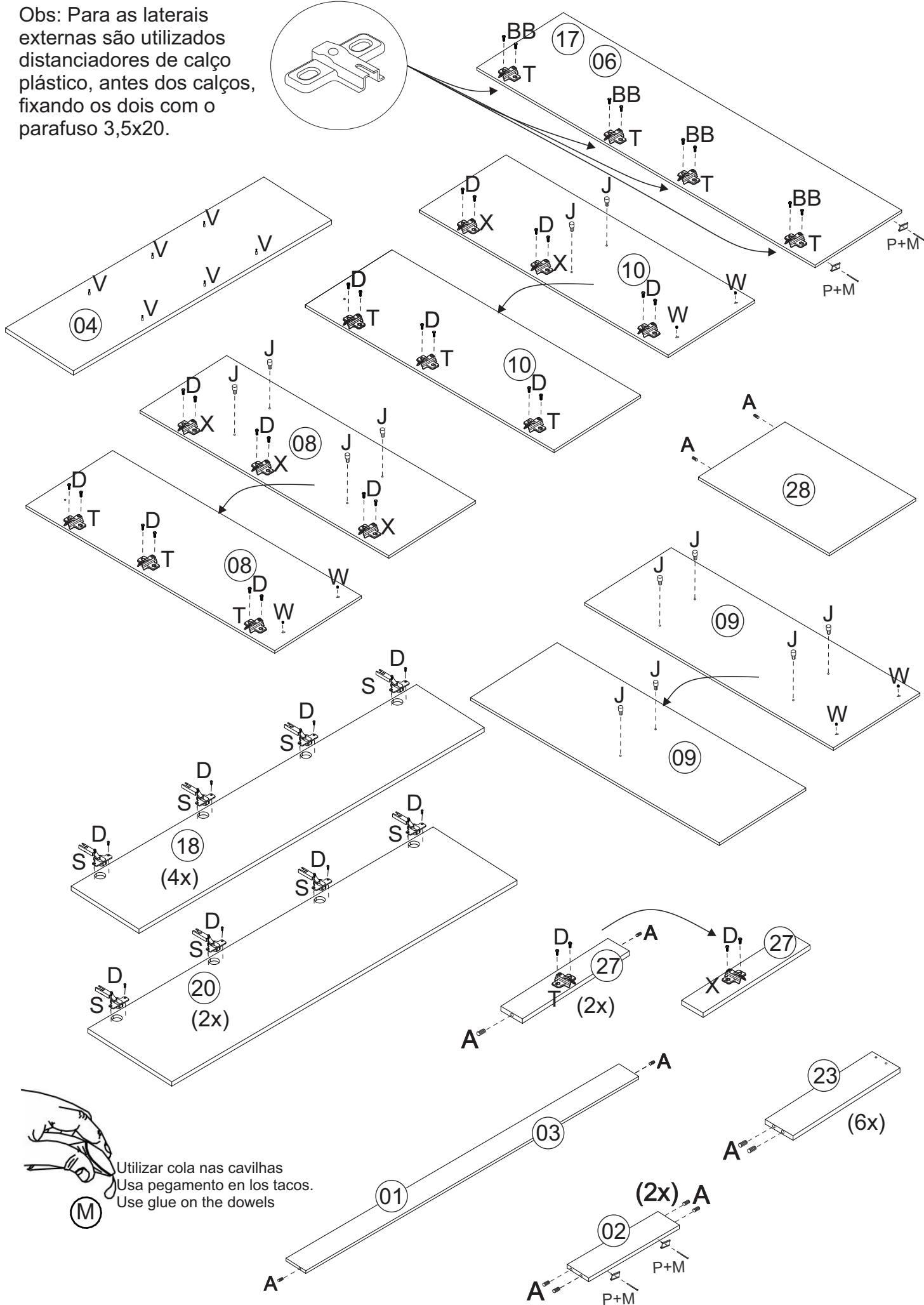
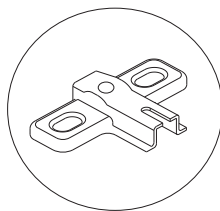

Utilizar cola nas cavilhas
Usa pegamento en los tacos.
Use glue on the dowels

(M)

01 Montagem/Montaje/Assembly

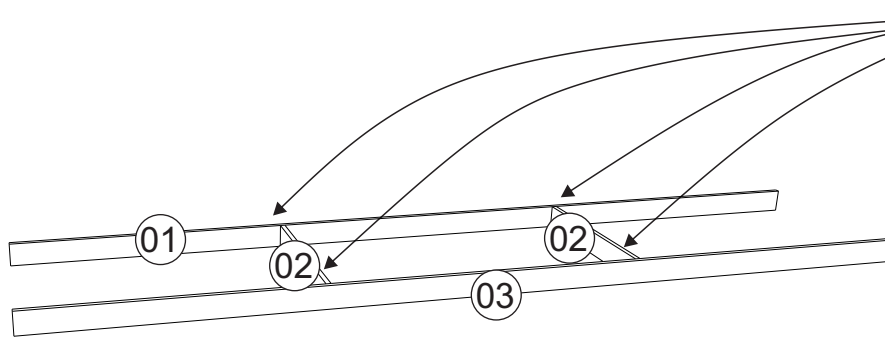
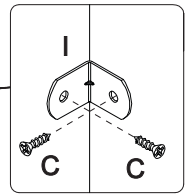

Obs: Ripa envoltório frontal (26), é fixada no rodapé frontal.

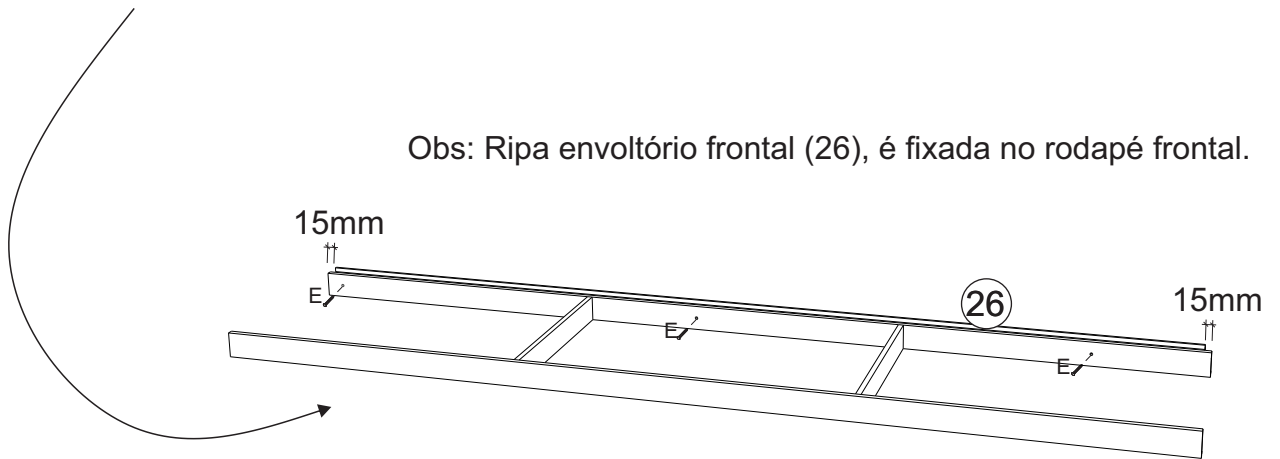

02 Montagem/Montaje/Assembly

Obs: Roupeiro pode ser montado em pé.

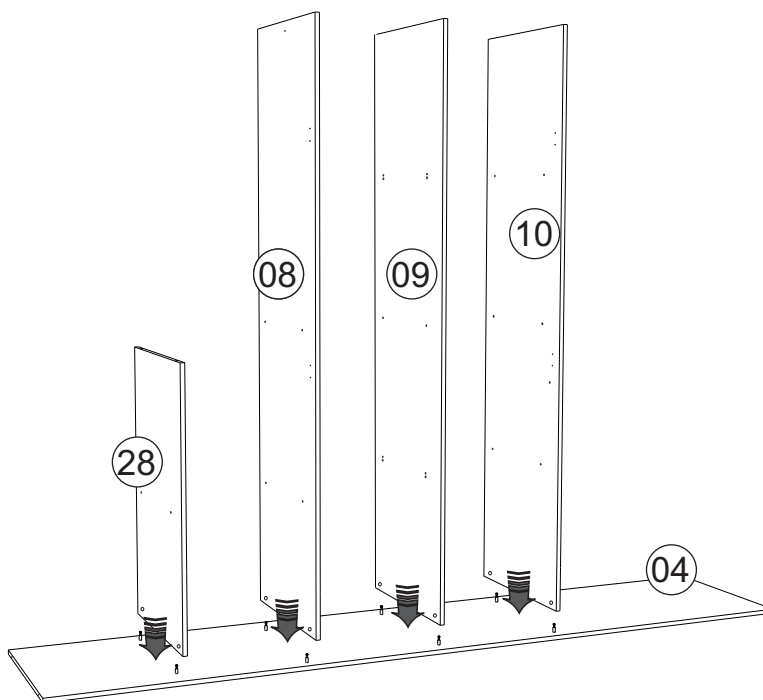

03 Montagem/Montaje/Assembly

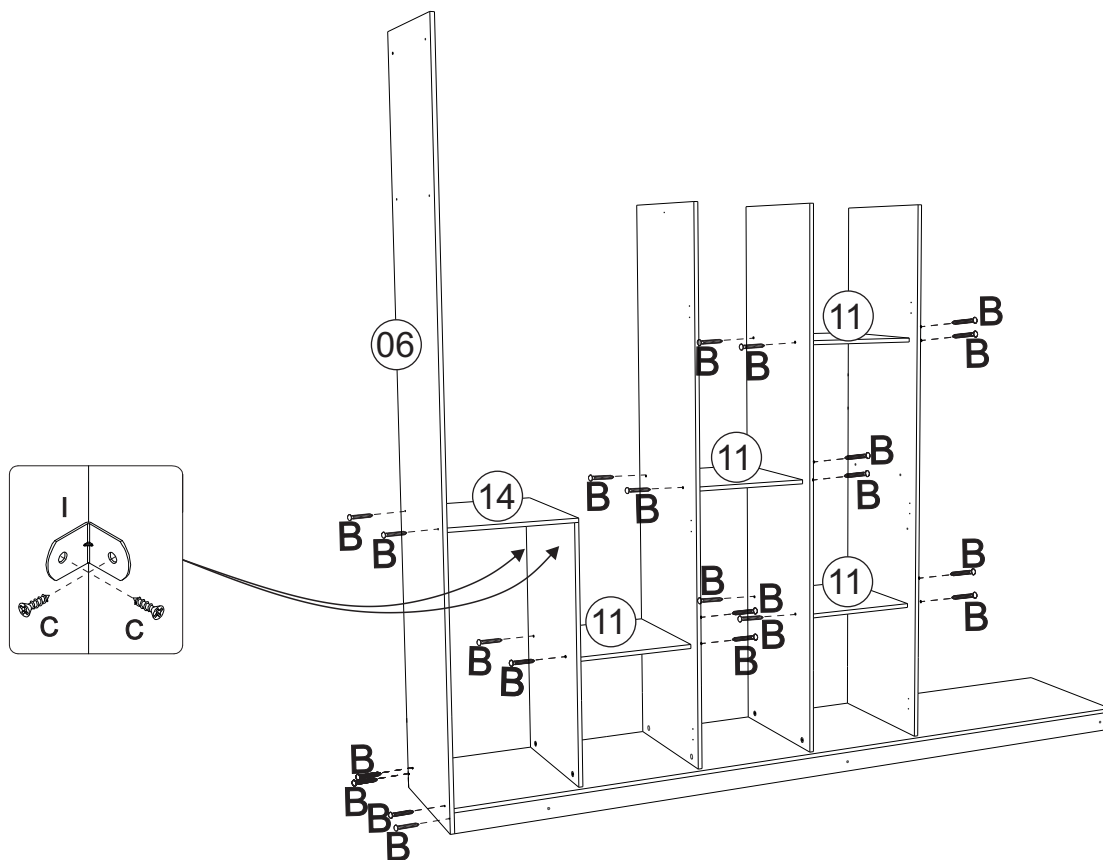

10

04 Montagem/Montaje/Assembly

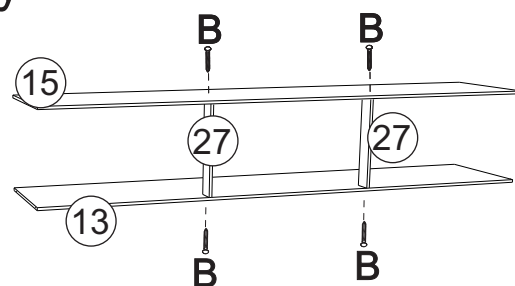
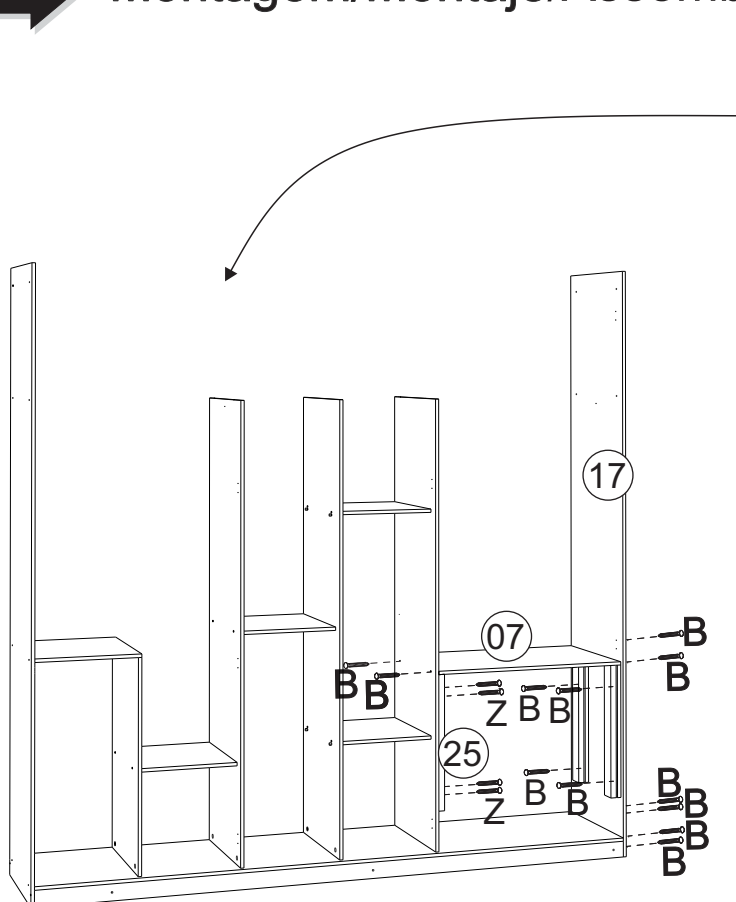

Obs: Fixar os dois distânciadores de gaveta junto, sendo primeiro a peça RG129.09.01 e conseqüentemente a RG129.09.00, as mesmas serão fixadas deste modo somente na lateral externa.

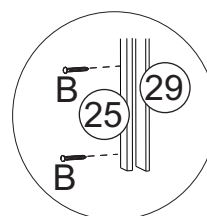

05 Montagem/Montaje/Assembly

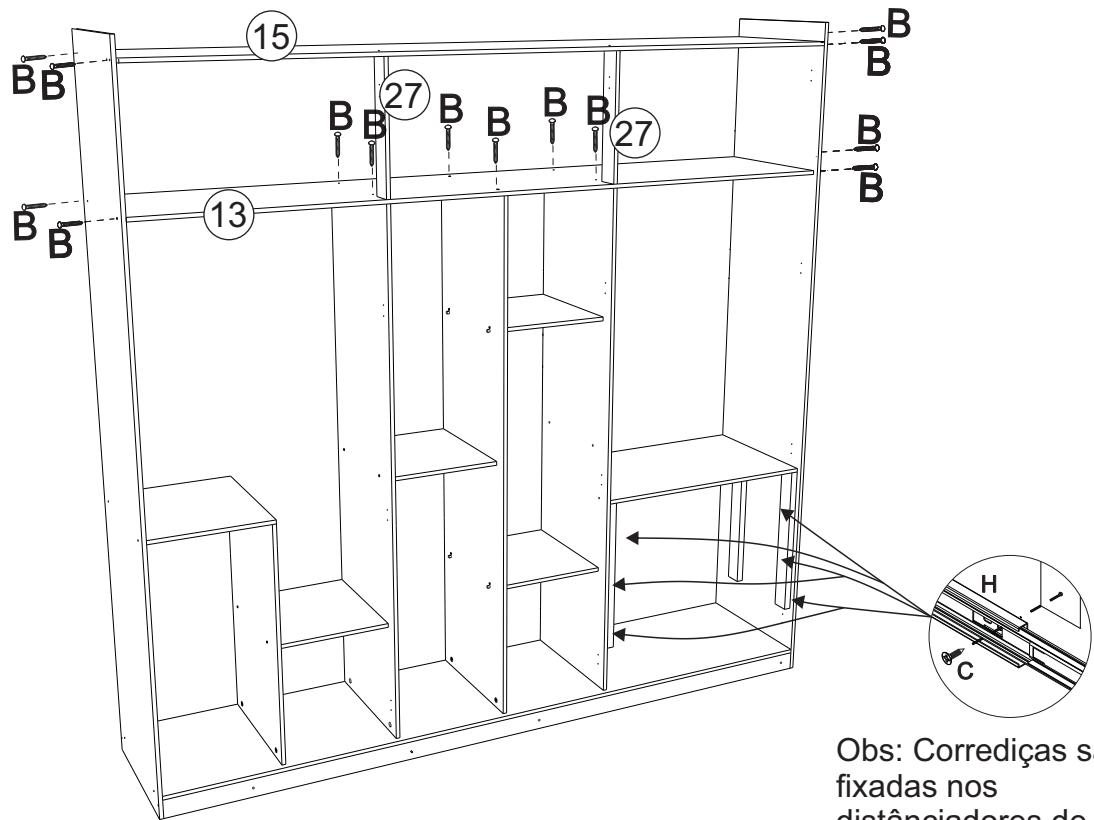

Obs: Corrediças são fixadas nos distânciadores de gaveta

06 Montagem/Montaje/Assembly

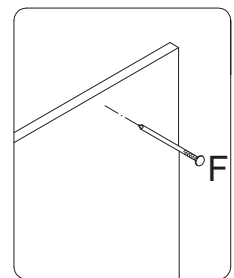
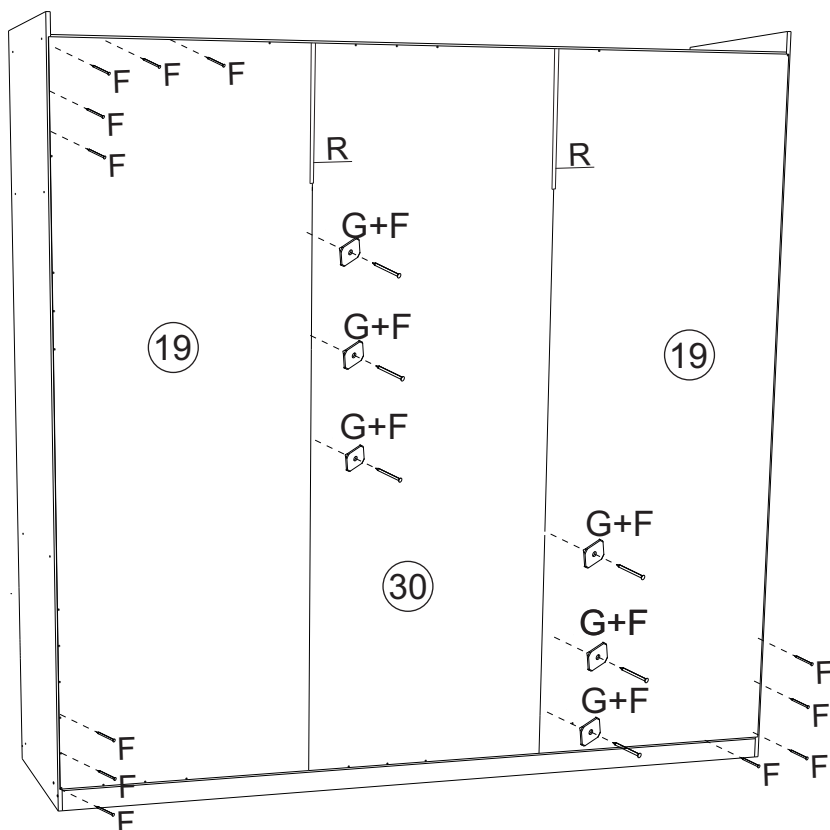

*Colocar um prego (F) a cada 100mm
 *Colocar un clavo cada (F) 100mm
 *Place a nail every (F) 100mm

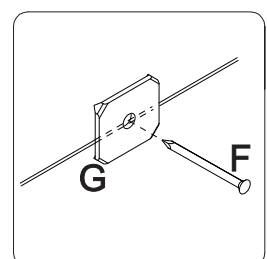

*Usar o prego (F) e a junção (G) a cada 150mm
 *Usar el clavo (F) y la junta (G) cada 150mm
 *Use the nail (F) and the joint (G) every 150mm

07 Montagem/Montaje/Assembly

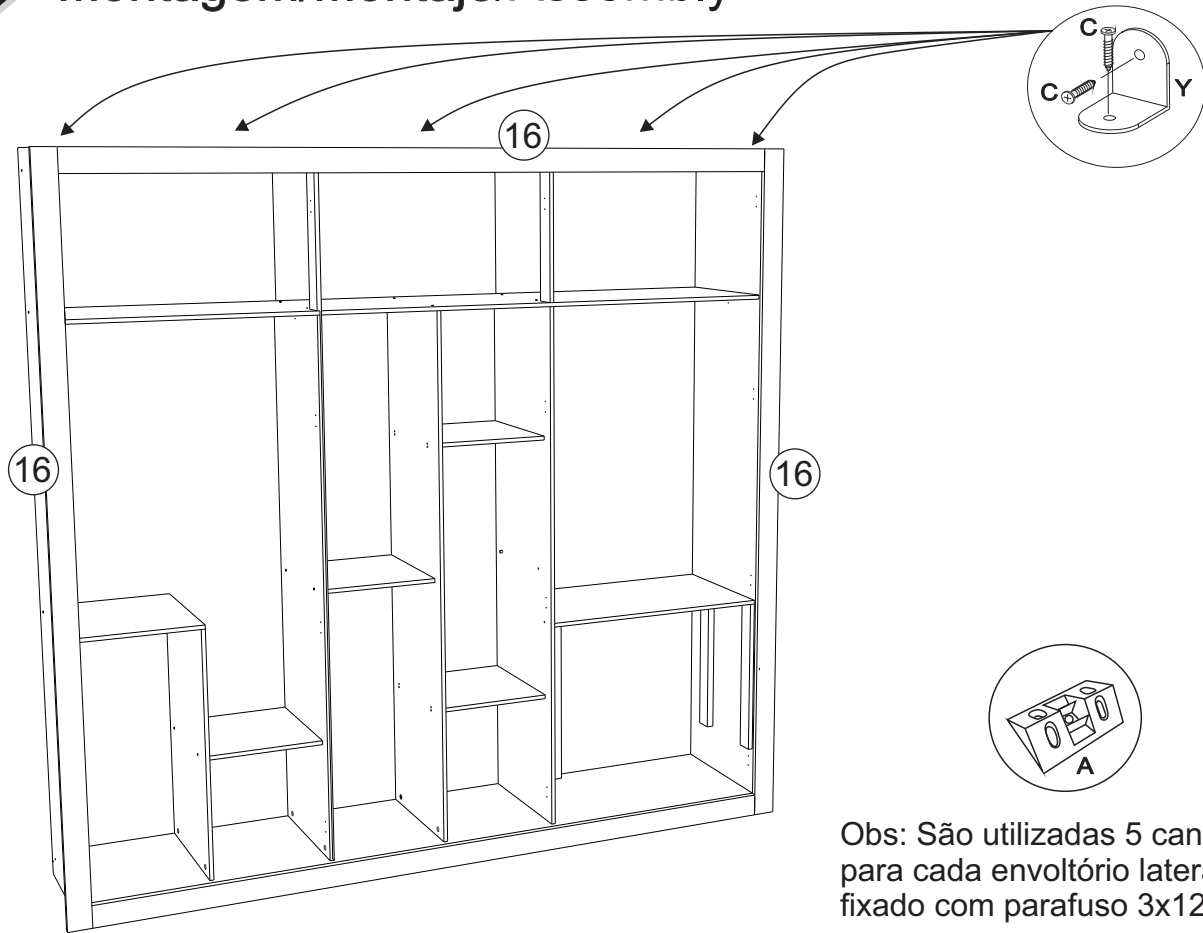

Obs: São utilizadas 5 cantoneiras para cada envoltório lateral, sendo fixado com parafuso 3x12.

08 Montagem/Montaje/Assembly

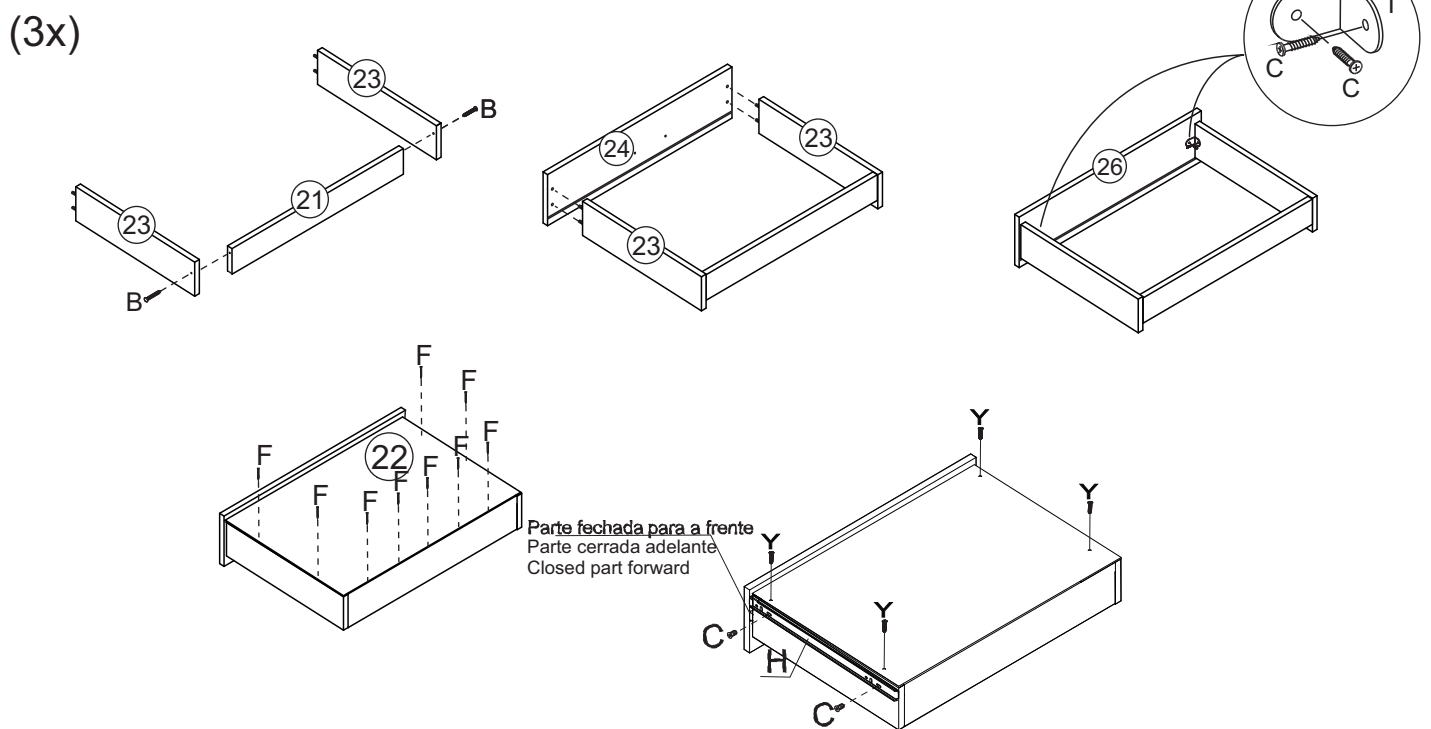



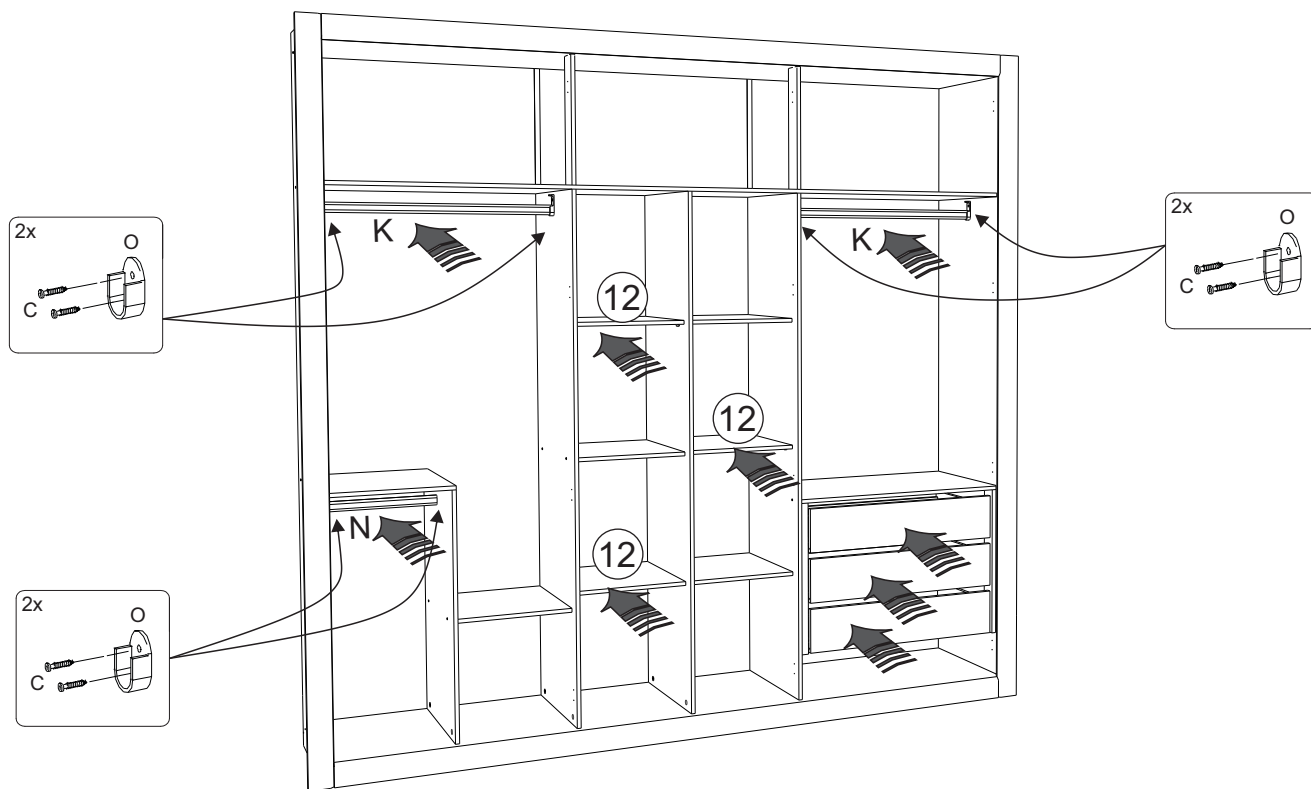

09 → Montagem/Montaje/Assembly

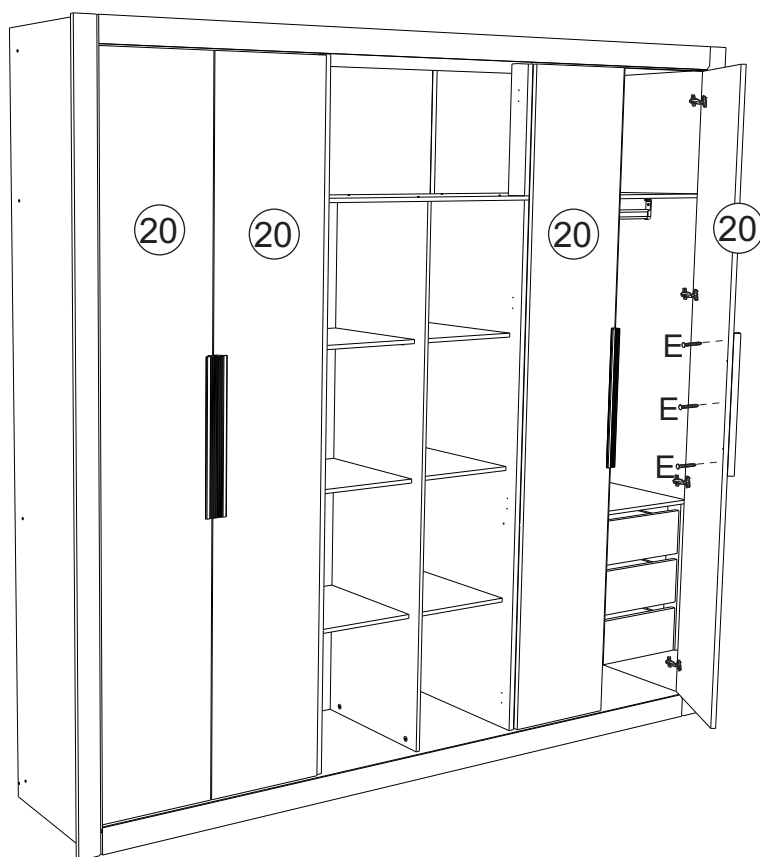

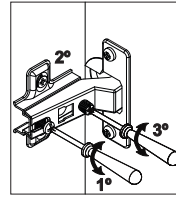
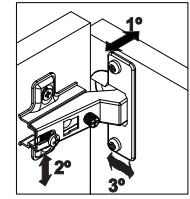
10 → Montagem/Montaje/Assembly



11**Montagem/Montaje/Assembly****1°****2°**

 Giz para madeira	Produto para ser aplicado em caso de riscos na superfície.
 Giz para madeira	Product to be applied in case of scratches on the surface.
 Giz para madeira	Producto para ser aplicado en caso de rayas en la superficie.



Medidas em mm
 Measures in mm
 Medidas en mm