

HENNInd. e Com. de Móveis Henn
Mondai - SC - Brasil

☎ +55 49 3674.3500

📧 @moveishenn
www.henn.com.brINSTRUCCIONES DE MONTAJE
ASSEMBLY INSTRUCTIONS**Roupeiro Vigo 6 Portas | Armario 6 Puertas Vigo |
Vigo 6 Doors Wardrobe**

D278-129 Off White/Nature

D278-169 Cinza/Nature

D278-198 Jequitibá Brilho

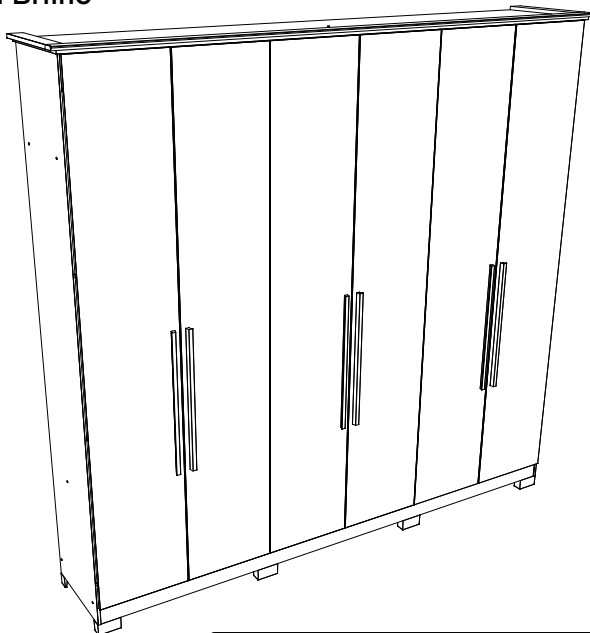
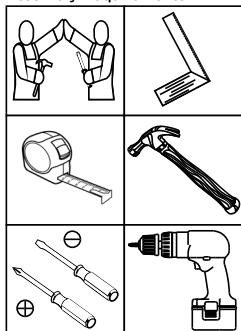
Requisitos para montagem
Requisitos para la montaje
Assembly Requirements

Imagens meramente ilustrativas,
não acompanha o produto.
Imágenes ilustrativas, no incluidas
con el producto.
Illustrative images, not included
with the product.

ASSISTÊNCIA TÉCNICA

Para solicitação de Assistência Técnica você consumidor deverá entrar em contato com o Lojista o qual você realizou a compra deste produto e solicitar a assistência técnica das peças avariadas. A garantia abrange todas as peças, partes e componentes que eventualmente venham apresentar defeito de fabricação no prazo de 03 (três) meses, contando a partir da entrega do produto ao consumidor, mediante nota fiscal de compra.

AVISO

Para limpeza de seu móvel, use uma flanela seca ou umedecida, e não utilize produtos químicos que possam danificar seu produto.

SISTEMA DE MONTAGEM

O sistema de montagem dos produtos, funciona de acordo com a ordem crescente dos números indicados no desenho. Ex: 01, 02, 03, 04... até a conclusão da montagem.

ADVERTENCIA

Para limpieza de su móvil, use una franela seca o húmeda, y no utilice productos químicos que puedan dañar su producto.

SISTEMA DE MONTAJE

El sistema de montaje de los productos funciona de acuerdo con el orden creciente de los números indicados en el dibujo. Ej.: 01, 02, 03, 04... hasta la conclusión del montaje.

NOTICE

To clean your furniture, use a dry or wet cloth, and do not use chemicals that may damage your product.

ASSEMBLY SYSTEM

The products' assembly system works according to the increasing order of the indicated numbers. For example: 01, 02, 03, 04 ... to the end of the assembly.

ACESSÓRIOS | ACCESORIOS | ACCESSORIES

A

**x4**

B

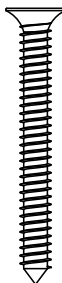
**x6**

C

**x26**

D

**x18**

E

**x16**

F

**x2**

G

**x9**

H

**x114**

I

**x54**

J

**x6**

K

**x82**

L

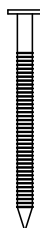
**x6**

M

**x148**

N

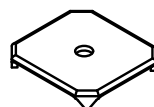
**x44**

O

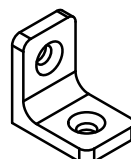
**x16**

Parafusos em escala
Tornillos escalados
Scaled screws

1:1

ACESSÓRIOS | ACCESORIOS | ACCESSORIES

P

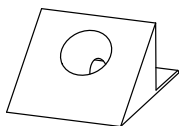

x6

Q

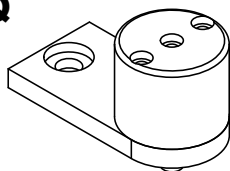

x6

R



x2

S



x4

T

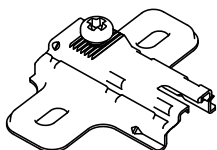

x24

U

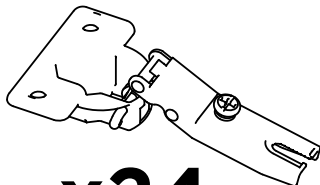

x24

V

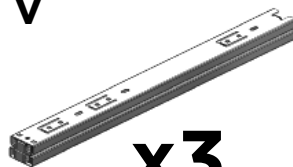

x3

W

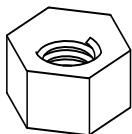

x16

X

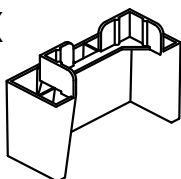

x8

Y

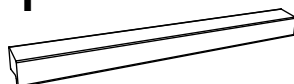

x6

Z

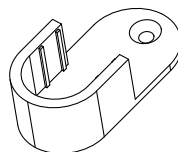

x6

AA

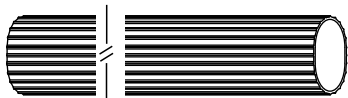

x3

AB



x3

AC



x3

AD

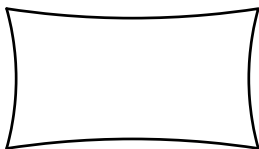

x2

AE

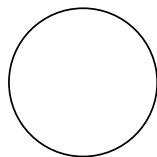

x4

AF

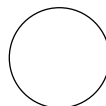

x30

AG



x1

LISTA DE PEÇAS | LISTA DE PIEZAS | LIST OF PIECES

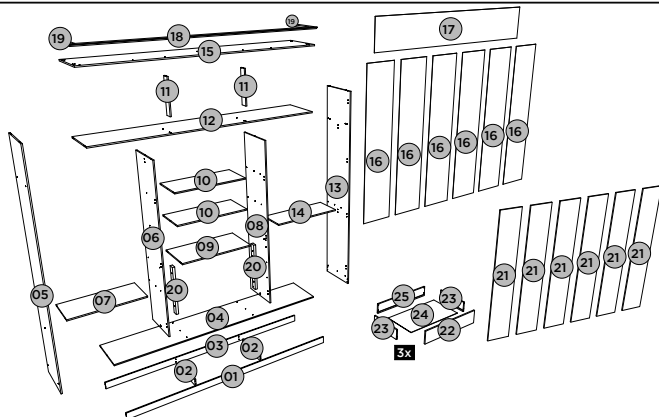



Item	Caixa Caja Box	Qtd Ctd Qty	Descrição Descripción Description	Dimensões (mm) Dimensiones (mm) Dimensions (mm)		
				Comprimento Largo Length	Lar- gura Ancho Width	Espes- sura Grosor Thick- ness
01	2/4	01	RODAPÉ FRONTAL RODAPIÉ FRONTAL FRONT BASEBOARD	2334	73	12
02	2/4	02	TRAVESSA DO RODAPÉ ZÓCALO BASEBOARD	390	73	12
03	2/4	01	RADAPÉ TRASEIRO RODAPIÉ TRASERO BACK FOOTBOARD	2334	73	12
04	2/4	01	BASE BASE BASE	2334	420	12
05	3/4	01	LATERAL ESQUERDA LADO IZQUIERDO LEFT SIDE	2223	420	12
06	1/4	01	DIVISÃO ESQUERDA DIVISIÓN IZQUIERDA LEFT DIVISION	1776	420	12
07=10=14	1/4	01	PRATELEIRA REPISA SHELF	770	350	12
08	1/4	01	DIVISÃO DIREITA DIVISIÓN CORRECTA RIGHT DIVISION	1776	420	12
09	1/4	01	TAMPO DAS GAVETAS TAPA DE LOS CAJONES TOP OF DRAWERS	770	400	12
10=07=14	1/4	02	PRATELEIRA REPISA SHELF	770	350	12
11	2/4	02	RIPA DO MALEIRO TRAVESAÑO SUPERIOR MALEIRO'S LATH	350	73	12
12	2/4	01	CHÃO DO MALEIRO REPISA SUPERIOR FLOOR OF MALEIRO	2334	420	12
13	3/4	01	LATERAL DIREITA LADO DERECHO RIGHT SIDE	2223	420	12
14=07=10	1/4	01	PRATELEIRA ESTANTE SHELF	770	350	12
15	2/4	01	TAMPO SUPERIOR PARTE SUPERIOR PARTE SUPERIOR TOP TOP	2378	440	12
16	3/4	06	FUNDO FONDO BOTTOM	1793	389	3
17	2/4	01	FUNDO SUPERIOR FONDO INFERIOR UPPER BOTTOM	2354	367	3
18	2/4	01	MOLDURA FRONTAL SUPERIOR MARCO FRONTAL SUPERIOR TOP FRONT FRAME	2418	60	15
19	3/4	02	MOLDURA LATERAL MARCO LATERAL SIDE FRAME	396	60	15
20	1/4	02	RIPA LATERAL LISTÓN LATERAL SIDE SLAT	502	58	25
21	4/4	06	PORTA PUERTA DOOR	2141	388	15
22	1/4	03	FRENTE DE GAVETA FRENTE DEL CAJÓN DRAWER FRONT	712	145	12
23	2/4	06	LADO DE GAVETA LATERAL DEL CAJÓN DRAWER SIDE	350	110	12
24	3/4	03	FUNDO DE GAVETA RECORTADO FONDO DE CAJÓN RECORTADO DRAWER BOTTOM TRIMMED	687	361	3
25	1/4	03	RIPA DE TRÁS TRAVESAÑO TRASERO REAR CLAPBOARD	700	110	12

PEÇAS REQUERIDAS

01	RODAPÉ FRONTAL	x1
02	TRAVESSA DO RODAPÉ	x2
03	RODAPÉ TRASEIRO	x1

ACESSÓRIOS REQUERIDOS

H		04
K		16
O		04

FERRAMENTAS NECESSÁRIAS

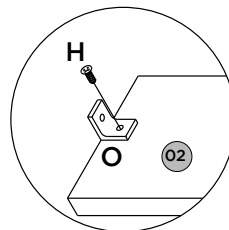
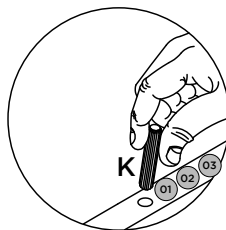
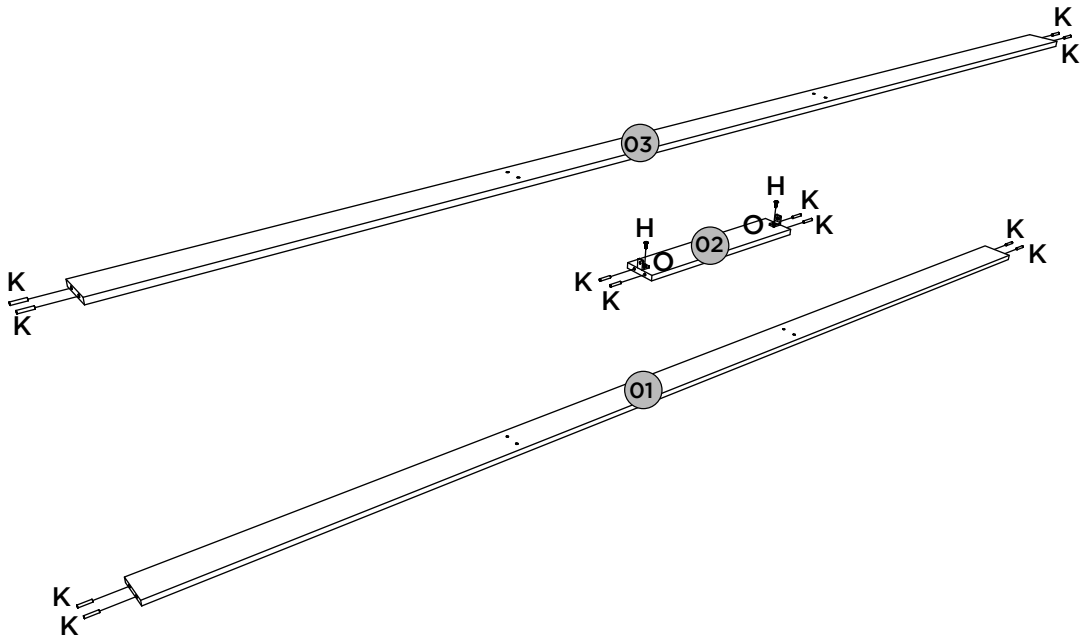
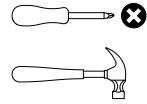

PEÇAS REQUERIDAS

04	BASE	x1
05	LATERAL ESQUERDA	x1
06	DIVISÃO ESQUERDA	x1

ACESSÓRIOS REQUERIDOS

F		02
H		08
I		04
K		08
S		04
T		04
Z		02

FERRAMENTAS NECESSÁRIAS

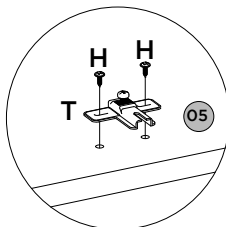
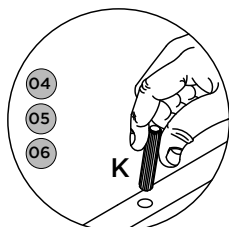
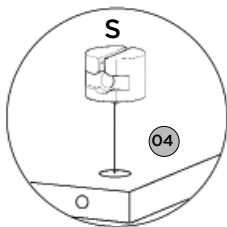
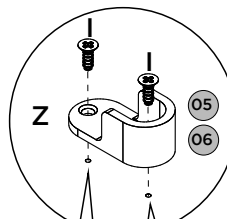
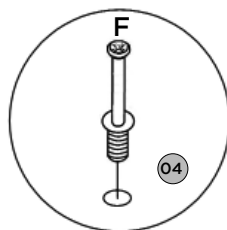
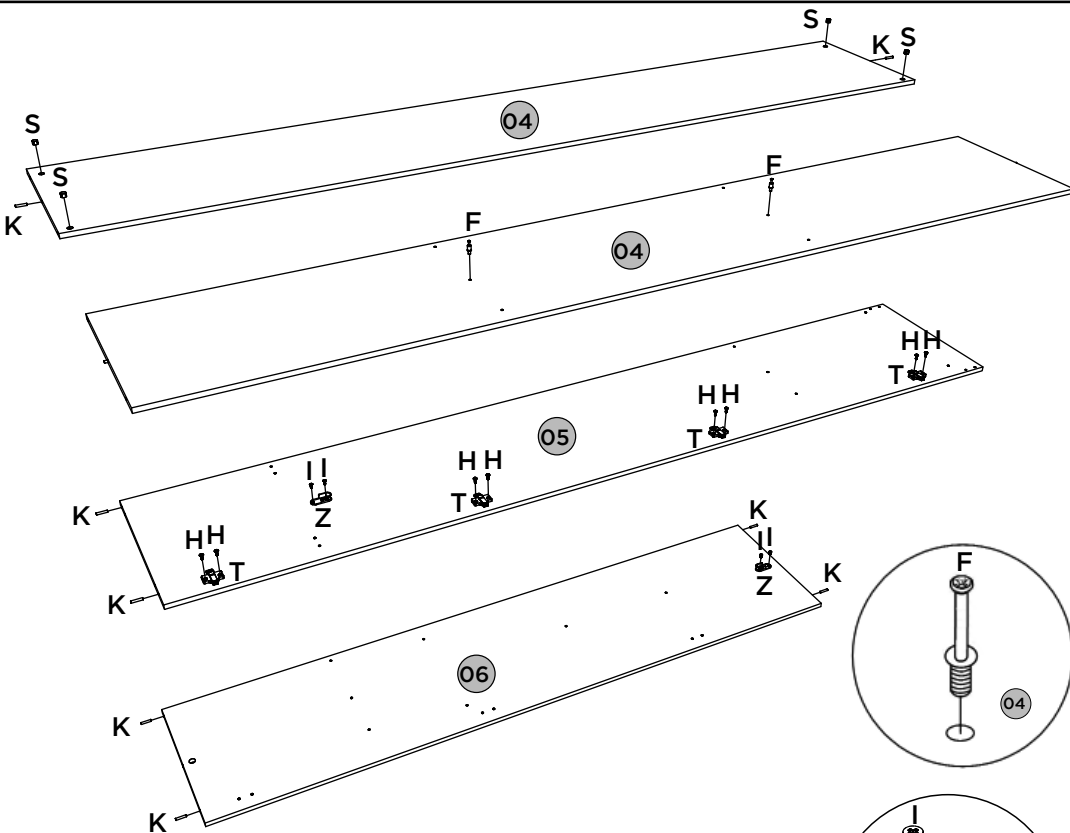
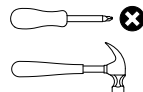



**Observe:
Furos
pré-marcados**

PEÇAS REQUERIDAS

08	DIVISÃO DIREITA	x1
09	TAMPO DAS GAVETAS	x1
07=10=14	PRATELEIRA	x4

ACESSÓRIOS REQUERIDOS

I		04
K		24
Z		02



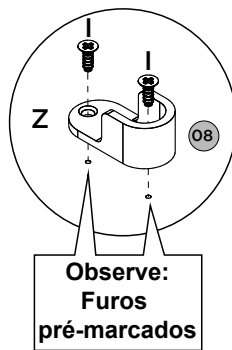
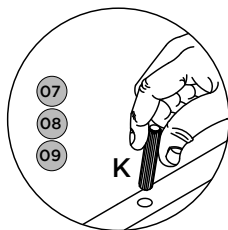
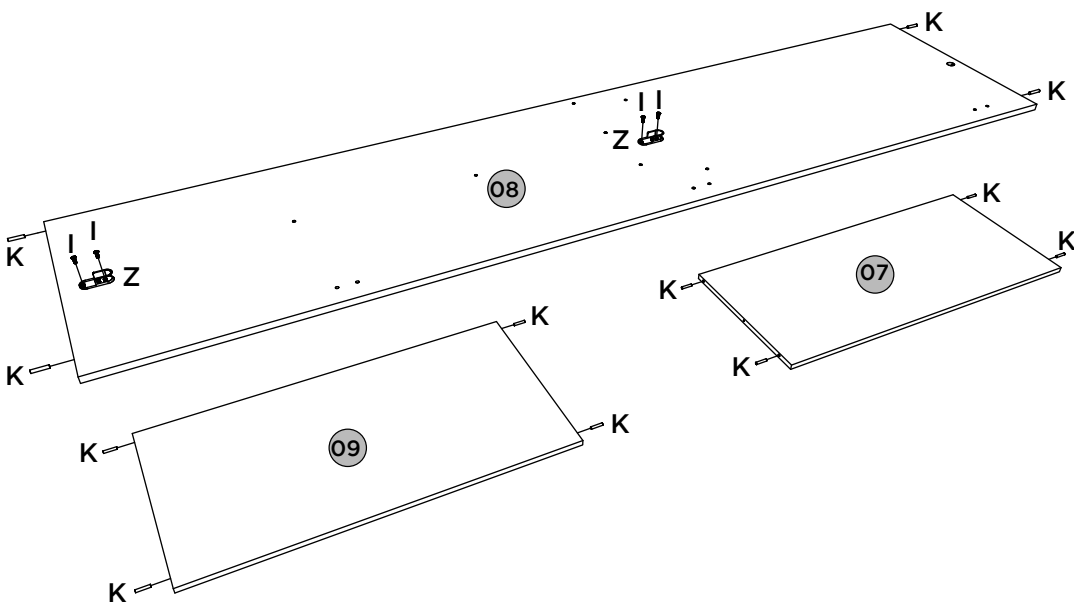
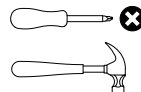

FERRAMENTAS NECESSÁRIAS



PASSO 4**PEÇAS REQUERIDAS**

13	LATERAL DIREITA	x1
----	-----------------	----

ACESSÓRIOS REQUERIDOS

H		08
I		04
K		02
T		04
Z		02

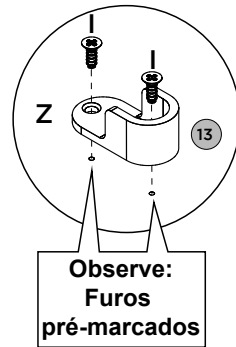
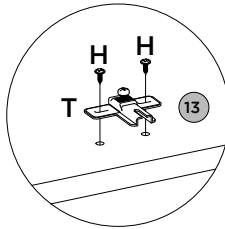
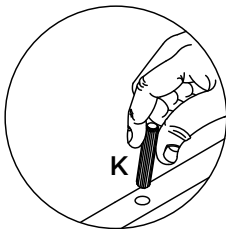
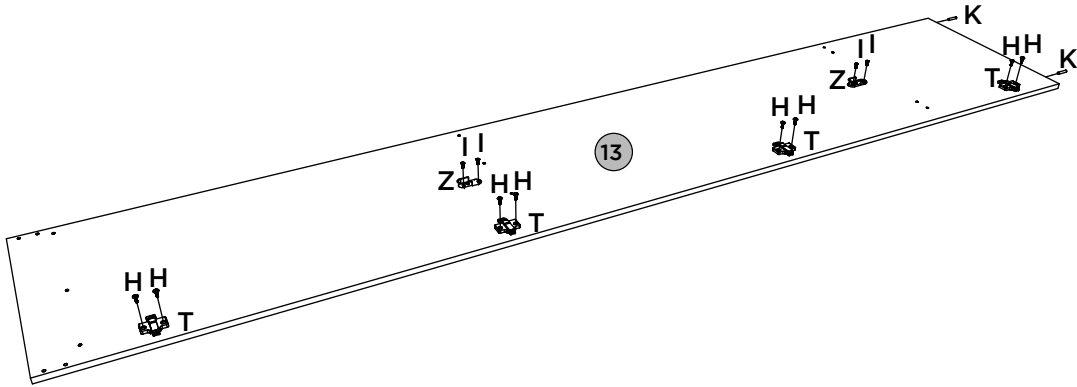
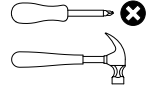
FERRAMENTAS NECESSÁRIAS

PASSO 5

ITM/D278-

PEÇAS REQUERIDAS

01	RODAPÉ FRONTAL	x1
02	TRAVESSA DO RODAPÉ	x2
03	RODAPÉ TRASEIRO	x1

ACESSÓRIOS REQUERIDOS





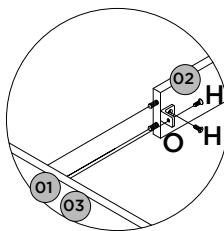
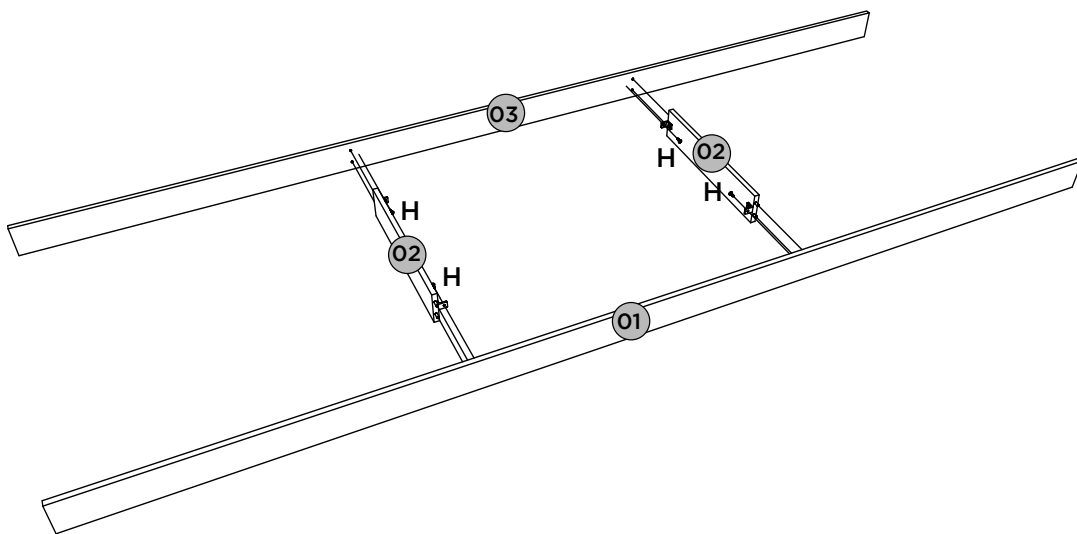
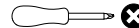

FERRAMENTAS NECESSÁRIAS



PASSO 6**PEÇAS REQUERIDAS**

04	BASE	x1
05	LATERAL ESQUERDA	x1
06	DIVISÃO ESQUERDA	x1
07	PRATELEIRA	x1

ACESSÓRIOS REQUERIDOS

A		02
C		02
H		12
O		06
R		01

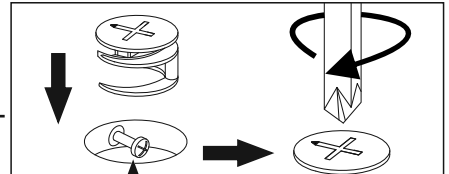
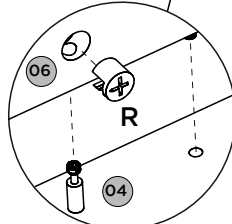
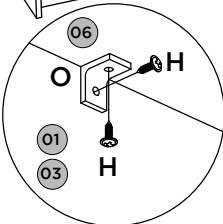
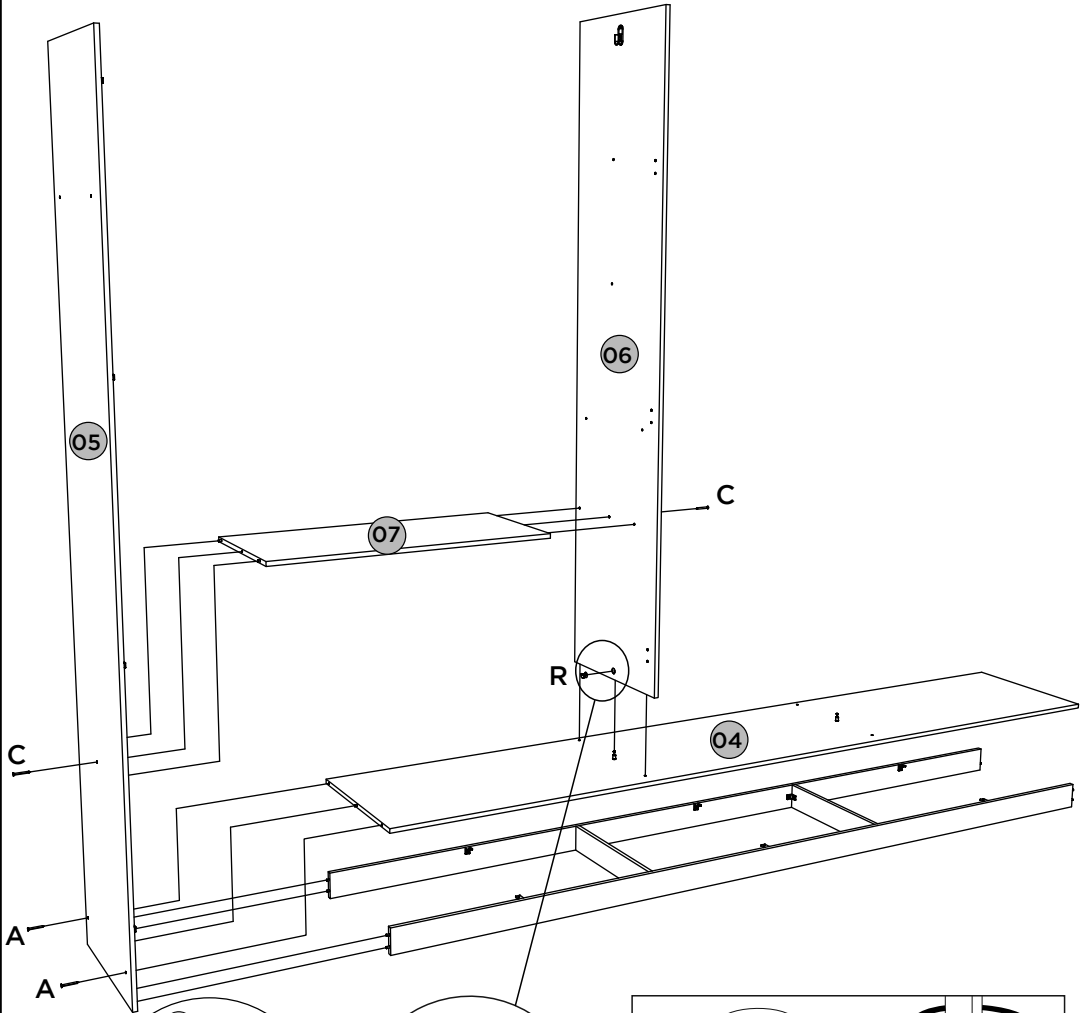
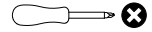
FERRAMENTAS NECESSÁRIAS

A cabeça do parafuso minifix precisa estar no centro



PASSO 7

ITM/D278-

PEÇAS REQUERIDAS

08	DIVISÃO DIREITA	x1
09	TAMPO DAS GAVETAS	x1
10=07	PRATELEIRA	x2

ACESSÓRIOS REQUERIDOS

C		08
R		01

FERRAMENTAS NECESSÁRIAS

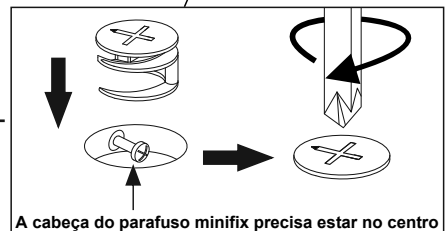
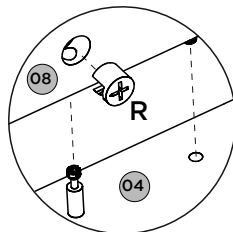
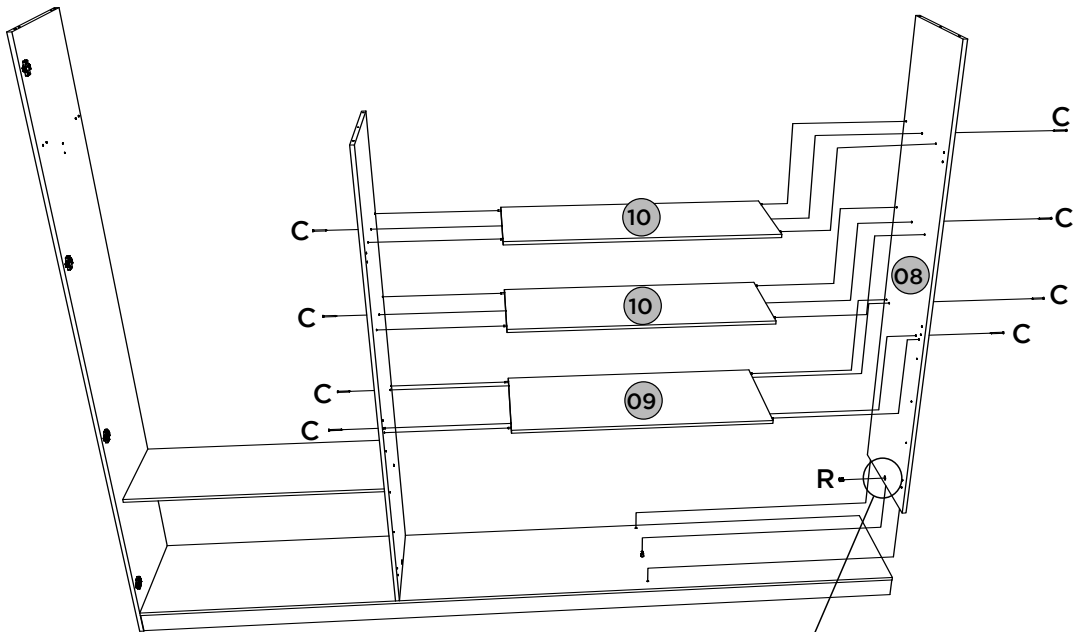
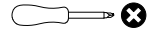

PASSO 8

ITM/D278-

PEÇAS REQUERIDAS

11	RIPA DO MALEIRO	x2
12	CHÃO DO MALEIRO	x1
13	LATERAL DIREITA	x1
14=07	PRATELEIRA	x1
15	TAMPO SUPERIOR	x1

ACESSÓRIOS REQUERIDOS

A		02
C		16
H		24
X		08

FERRAMENTAS NECESSÁRIAS

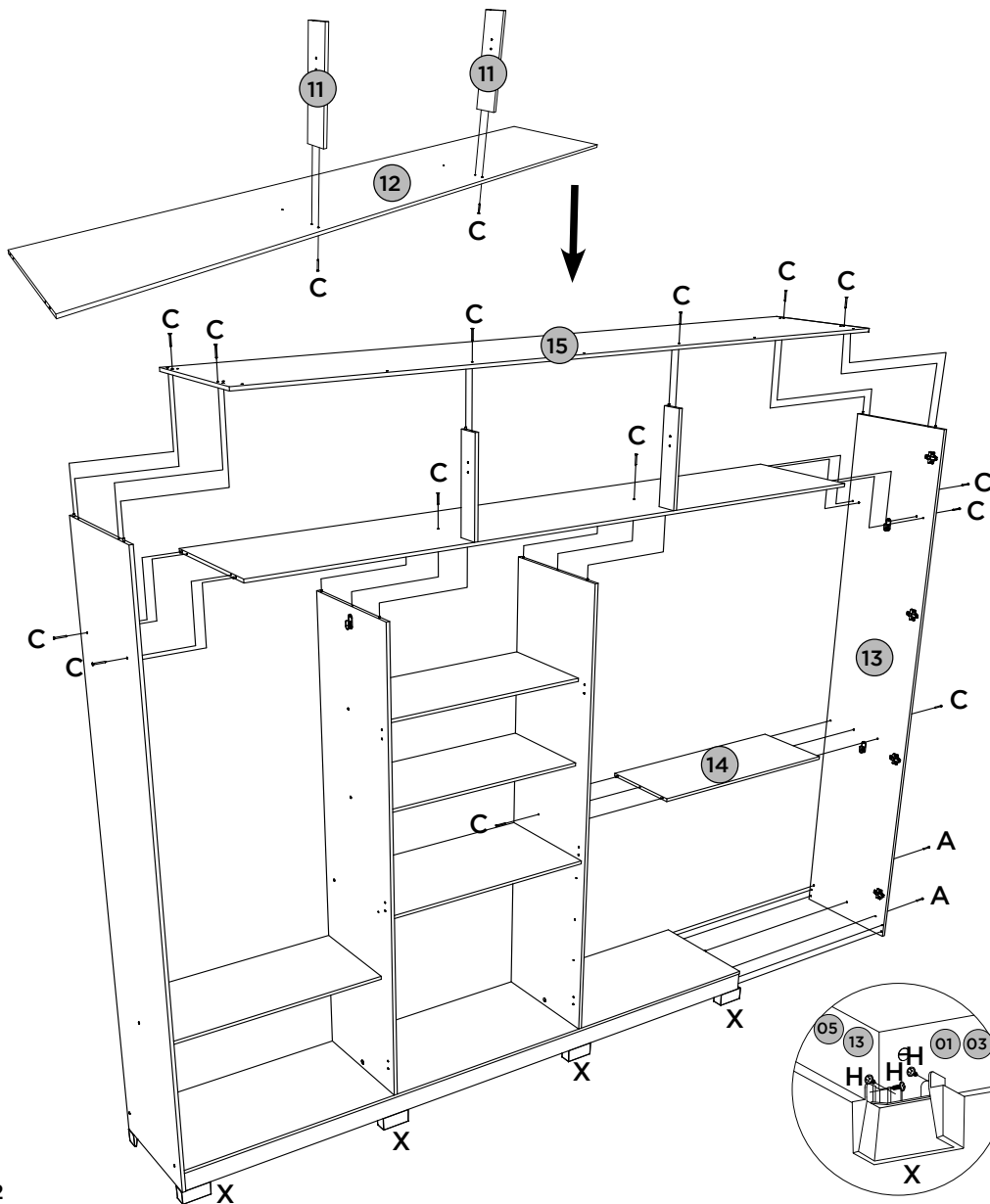
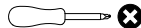



PASSO 9

ITM/D278-

PEÇAS REQUERIDAS

16	FUNDO	x6
17	FUNDO SUPERIOR	x1

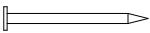
ACESSÓRIOS REQUERIDOS

M		148
N		44
AB		03



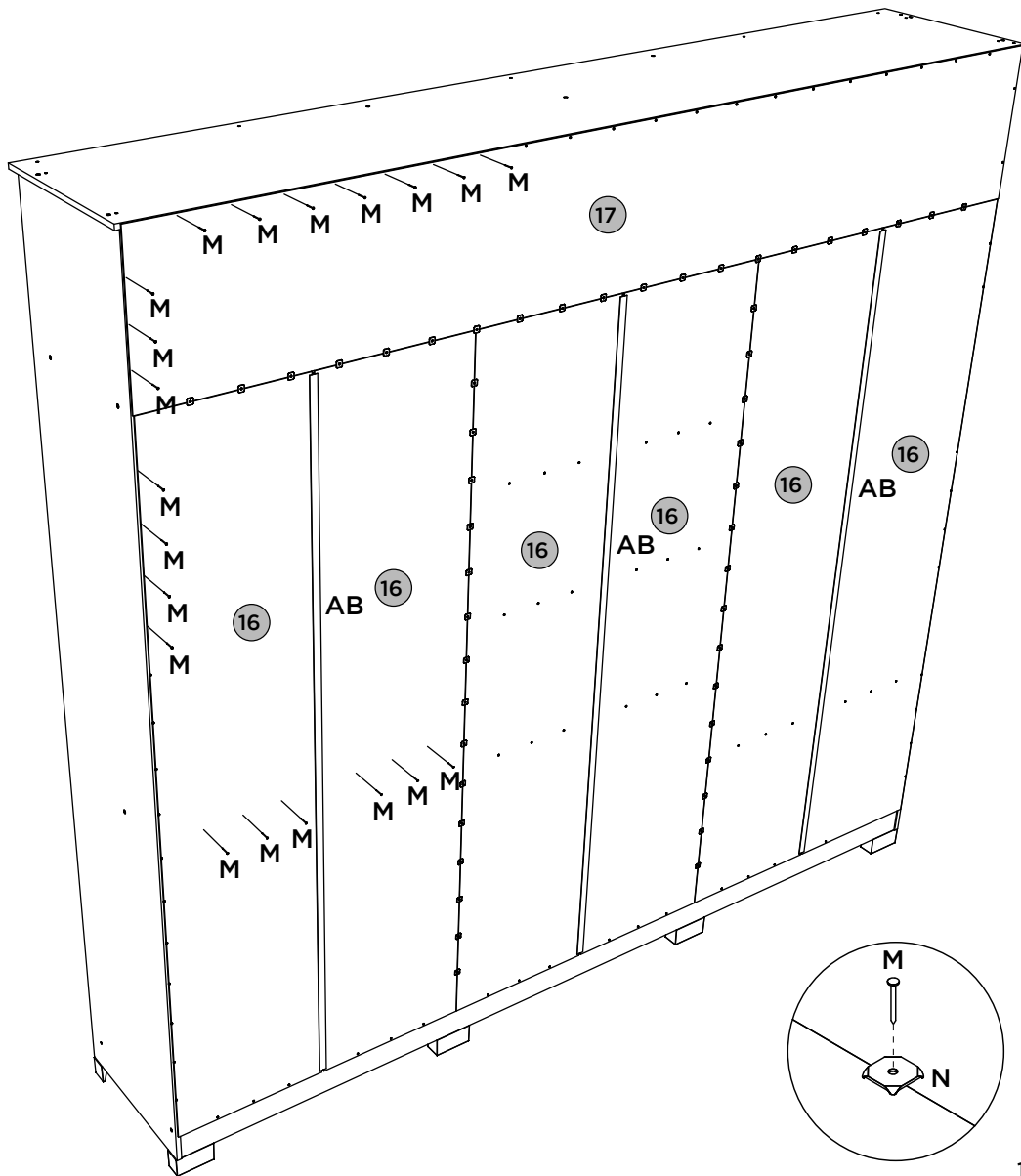
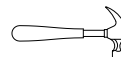





FERRAMENTAS NECESSÁRIAS



PASSO 10**PEÇAS REQUERIDAS**

18	MOLDURA FRONTAL SUPERIOR	x1
19	MOLDURA LATERAL	x2
20	RIPA LATERAL	x2

ACESSÓRIOS REQUERIDOS

B		06
E		16
G		09
H		06
Q		06
T		16
W		16
AA		03

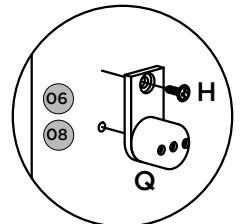
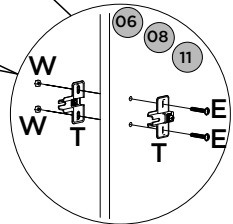
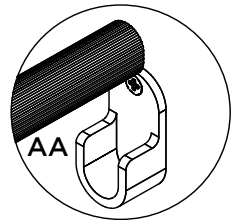
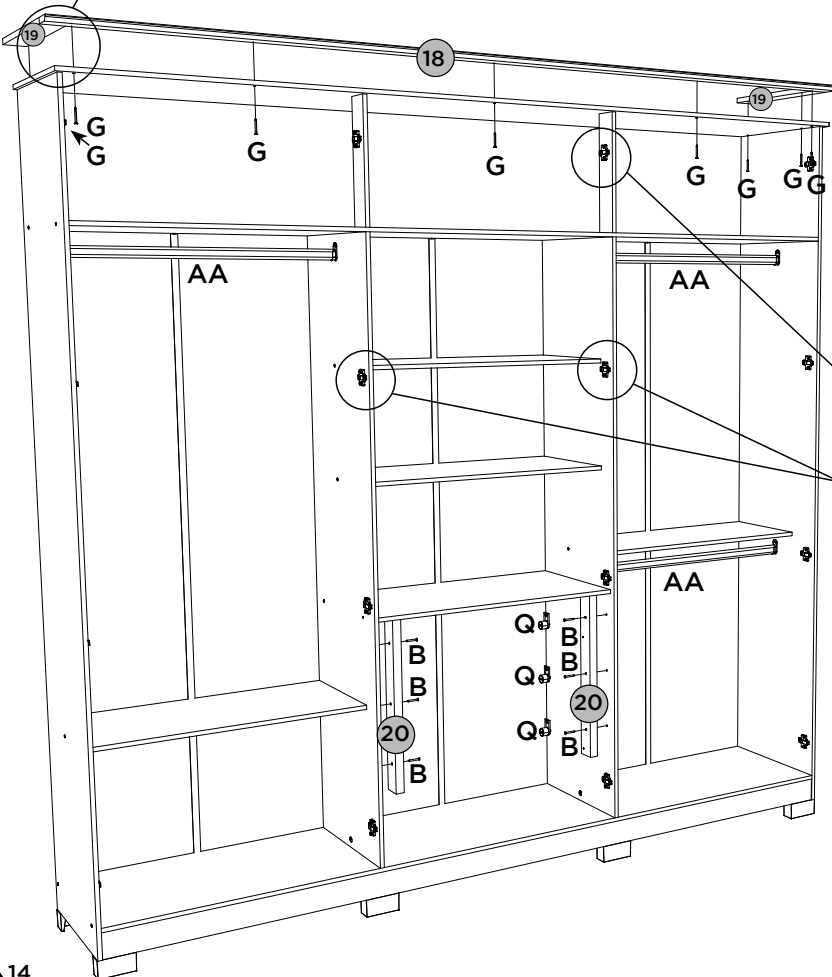
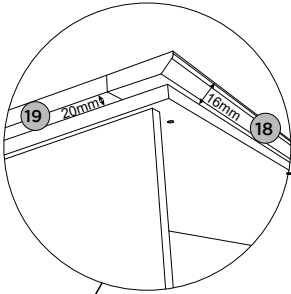
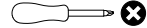
FERRAMENTAS NECESSÁRIAS



PASSO 11

ITM/D278-

PEÇAS REQUERIDAS

21	PORTA	x6
----	-------	----

ACESSÓRIOS REQUERIDOS

H		48
U		24

FERRAMENTAS NECESSÁRIAS

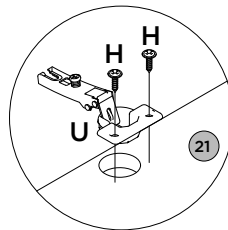
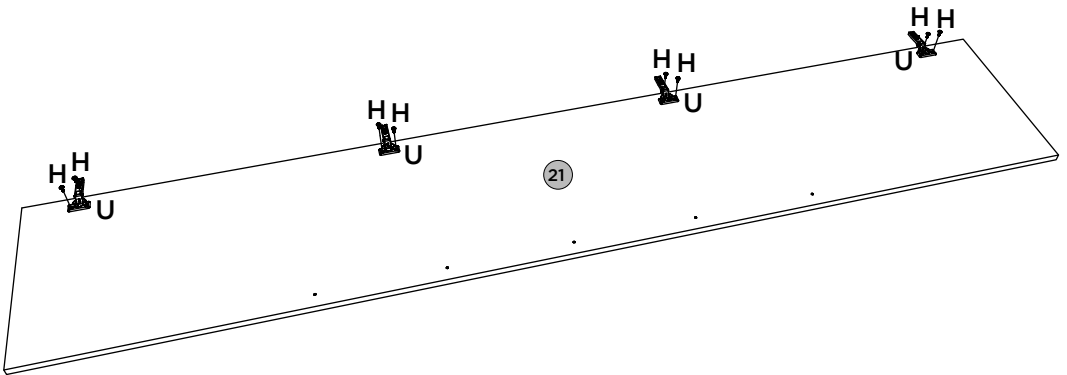
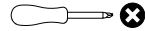

PEÇAS REQUERIDAS

21	PORTA	x6
----	-------	----

ACESSÓRIOS REQUERIDOS

D		18
I		12
V		03
Y		06

FERRAMENTAS NECESSÁRIAS



Para porta (21): Defina para o modo de perfuração.
Faça a furação passante para fixar os puxadores (Y).

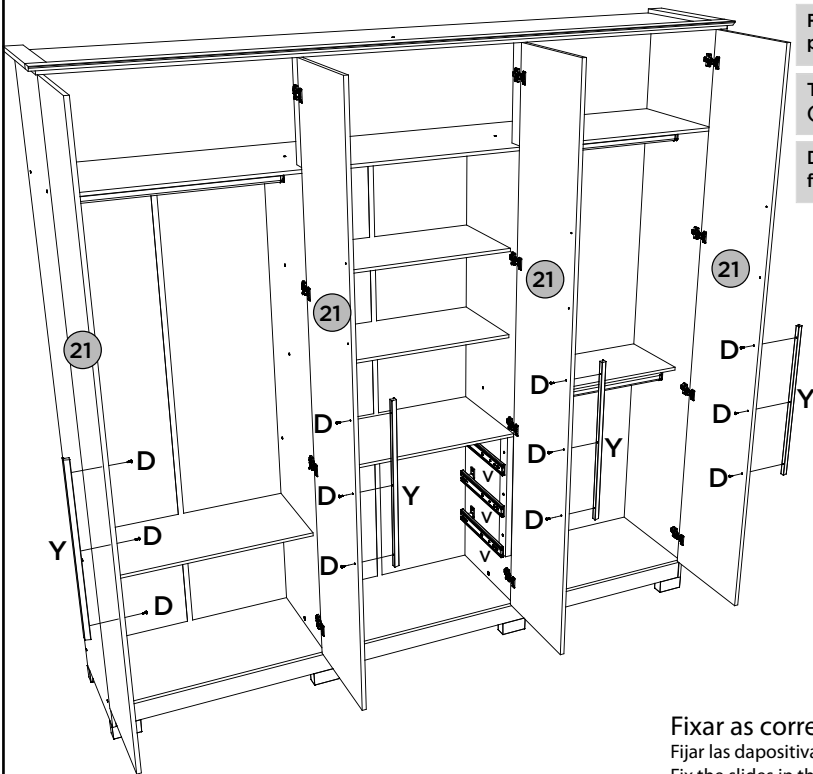

Fazer furação passante na porta (21) para puxador (Y)

Taladre a través de la puerta (21) para la manija (Y)

Drill through the door (21) for handle (Y)

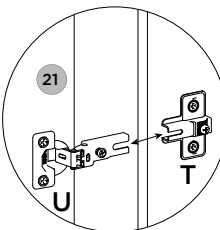
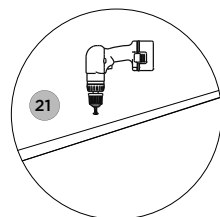

Fixar as correijas nessas furações
Fijar las dapositivas de estos agujeros
Fix the slides in these holes

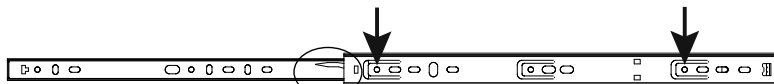

Para a desmontagem da correija, siga a instrução ao lado

Para el desmontaje de la diapositiva, siga las instrucciones en el lado



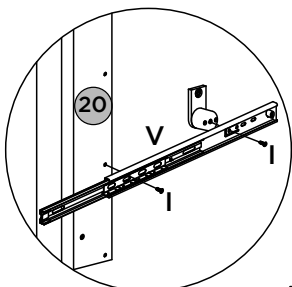
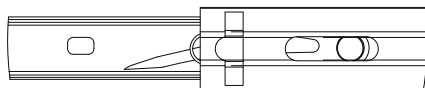
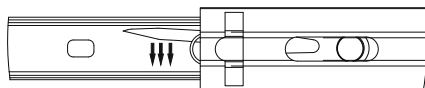

For disassembly of the slide, follow the instruction on the side



PASSO 13**PEÇAS REQUERIDAS**

22	FRENTE DE GAVETA	x3
23	LADO DE GAVETA	x6
24	FUNDO DE GAVETA RECORTADO	x3

ACESSÓRIOS REQUERIDOS



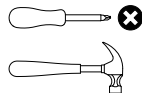
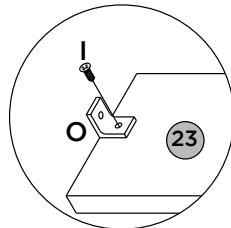
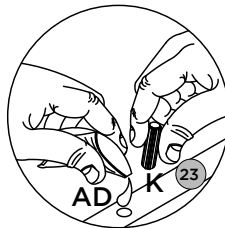
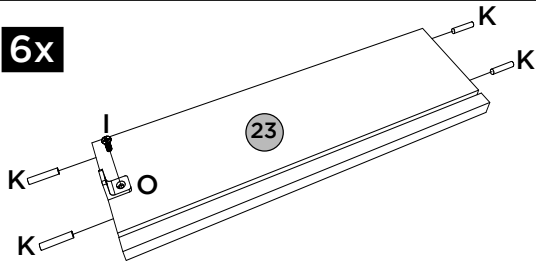
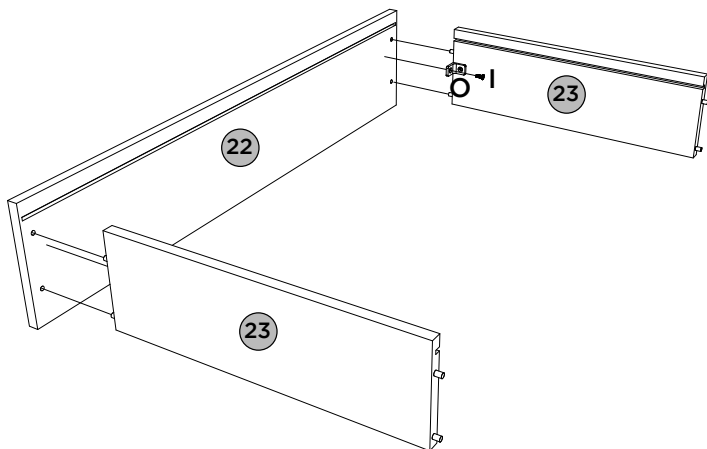
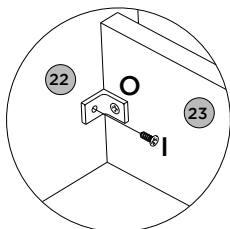
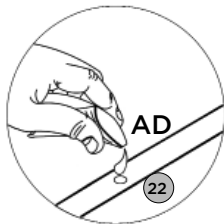
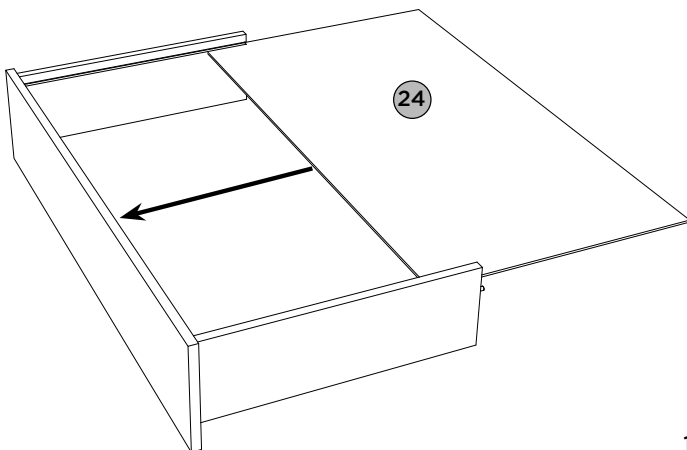
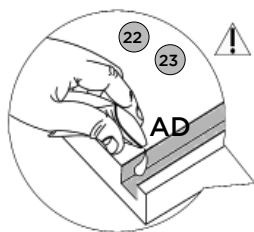



I		06
K		24
O		06
AD		

FERRAMENTAS NECESSÁRIAS**6x****3x**
1º**3x**
2º

PASSO 14**PEÇAS REQUERIDAS**



25	RIPA DE TRÁS	x3
----	--------------	----

ACESSÓRIOS REQUERIDOS

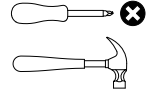
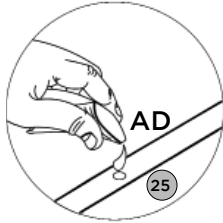
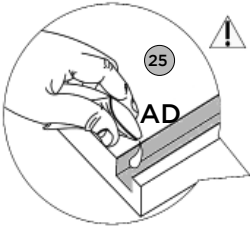
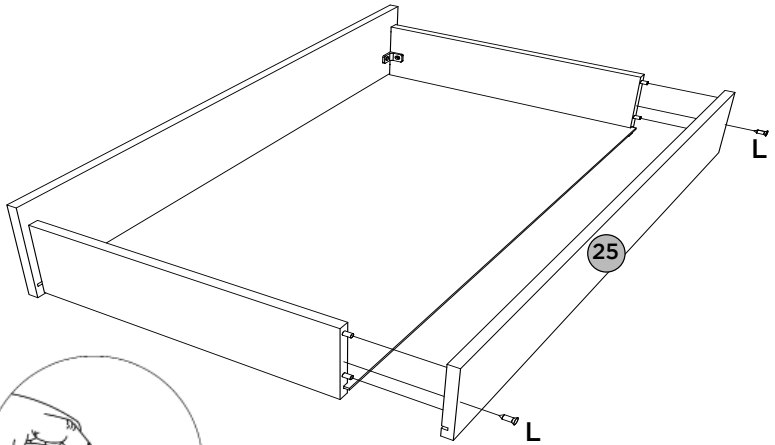
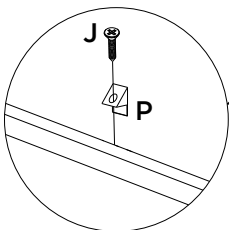
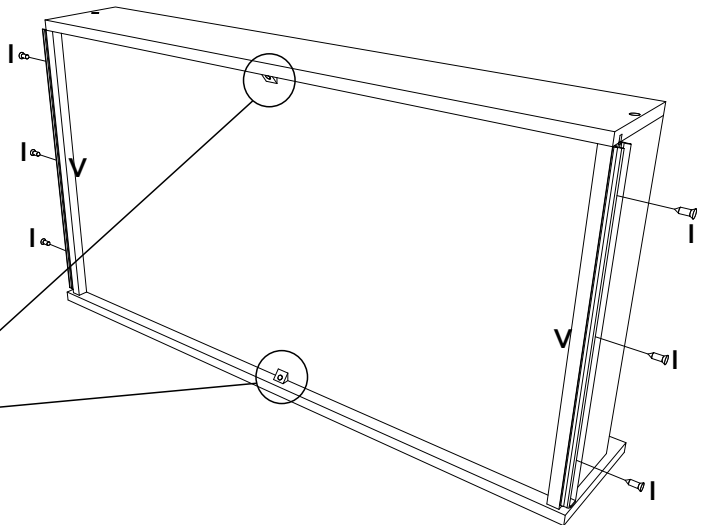
I		18
J		06
L		06
P		06
V		03
AD		

FERRAMENTAS NECESSÁRIAS**3x**
3º**3x**
4º

ACESSÓRIOS REQUERIDOS

AE		04
AF		30
AC		03
AG	HENN	01

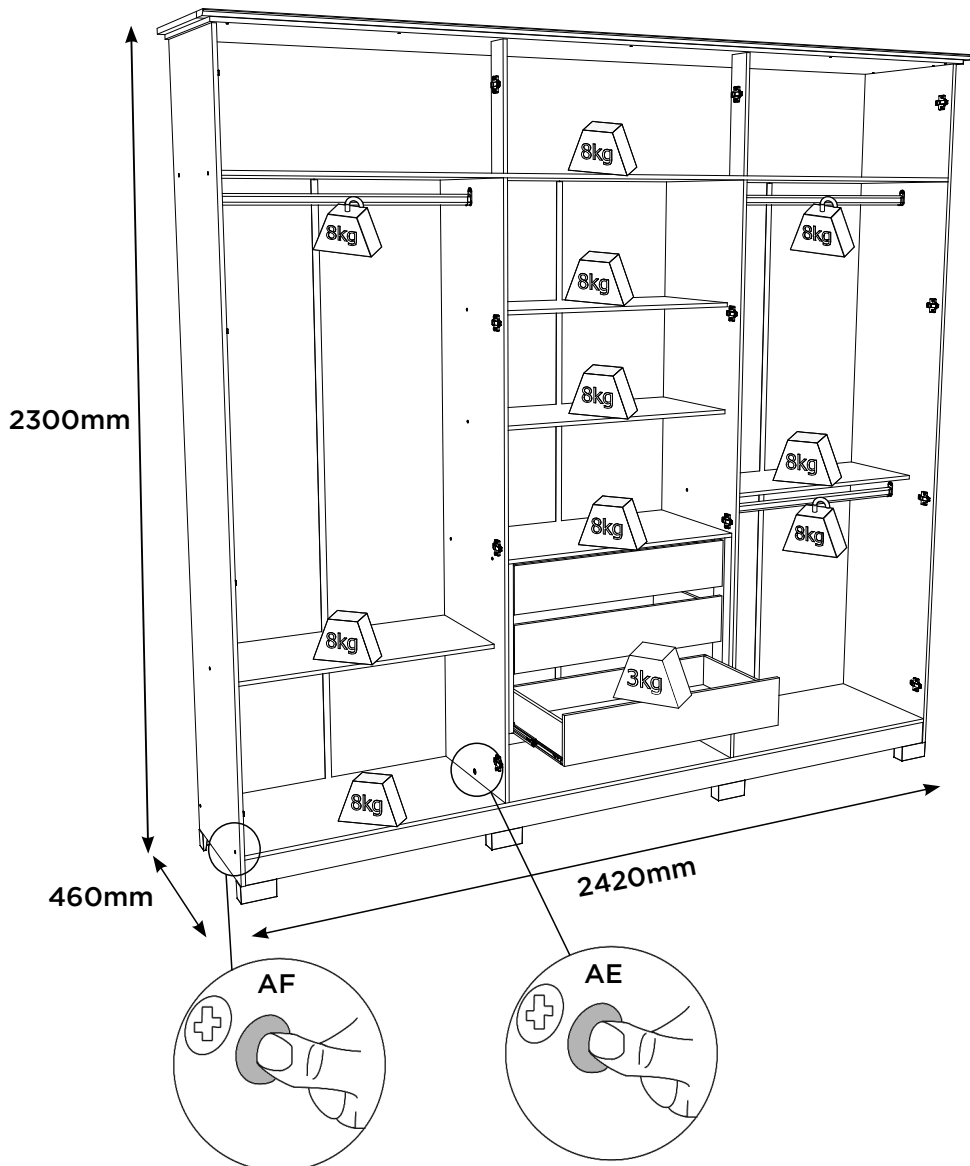

Pesos máximos recomendados com carga distribuída
 Peso máximo recomendado con la carga distribuida
 Recommended maximum weight with distributed load.

Produto Concluído
Producto terminado
Finished Product

