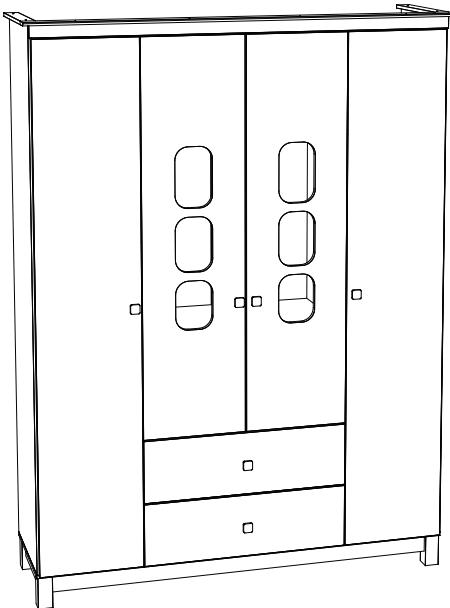
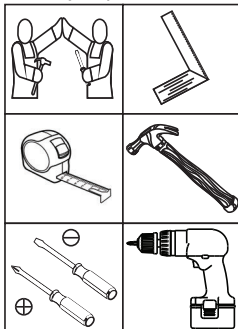

**HENN**Ind. e Com. de Móveis Henn  
Mondaí - SC - Brasil

☎ +55 49 3674.3500

📱 @moveishenn  
www.henn.com.br**INSTRUÇÕES DE  
MONTAGEM**INSTRUCCIONES DE MONTAJE  
ASSEMBLY INSTRUCTIONS**Roupeiro Aconchego 4 Portas | Armario Aconchego 4  
Puertas | Wardrobe Aconchego 4 Doors**

I129-190 Branco/Jequitibá HP

**Requisitos para montagem  
Requisitos para la montaje  
Assembly Requirements**

Imagens meramente ilustrativas,  
não acompanha o produto.  
Imágenes ilustrativas, no incluidas  
con el producto.  
Illustrative images, not included  
with the product.

**AVISO**

Para limpeza de seu móvel, use uma flanela seca ou umedecida, e não utilize produtos químicos que possam danificar seu produto.

**SISTEMA DE MONTAGEM**

O sistema de montagem dos produtos, funciona de acordo com a ordem crescente dos números indicados no desenho. Ex: 01, 02, 03, 04... até a conclusão da montagem.

**ASSISTÊNCIA TÉCNICA**

Para solicitação de Assistência Técnica você consumidor deverá entrar em contato com o Lojista o qual você realizou a compra deste produto e solicitar a assistência técnica das peças avariadas. A garantia abrange todas as peças, partes e componentes que eventualmente venham apresentar defeito de fabricação no prazo de 03 (três) meses, contando a partir da entrega do produto ao consumidor, mediante nota fiscal de compra. Se houver qualquer alteração na estrutura do produto ou ocorrer defeito por negligência do montador/consumidor em relação a instrução de montagem e manuseio, não será fornecido assistência técnica gratuita.

**ADVERTENCIA**

Para limpeza de su móvil, use una flanela seca o húmeda, y no utilice productos químicos que puedan dañar su producto.

**SISTEMA DE MONTAJE**

El sistema de montaje de los productos funciona de acuerdo con el orden creciente de los números indicados en el dibujo. Ej.: 01, 02, 03, 04... hasta la conclusión del montaje.

**ASISTENCIA TÉCNICA**

Para solicitar Asistencia Técnica, el consumidor debe comunicarse con el Comercio que usted realizó la compra de este producto y solicita asistencia técnica para las partes dañadas. La garantía cubre todas las partes, piezas y componentes que eventualmente puedan presentar defecto de fabricación en el plazo de 03 (tres) meses, contados a partir de la entrega del producto al consumidor, mediante factura de compra. Si se produce algún cambio en la estructura del producto o se produce un defecto por negligencia del montador/consumidor en relación con las instrucciones de montaje y manipulación, no se prestará asistencia técnica gratuita.

**NOTICE**

To clean your furniture, use a dry or wet cloth, and do not use chemicals that may damage your product.

**ASSEMBLY SYSTEM**

The products' assembly system works according to the increasing order of the indicated numbers. For example: 01, 02, 03, 04 ... to the end of the assembly.

**TECHNICAL ASSISTANCE**

To request Technical Assistance, the consumer must contact the retailer from whom you purchased this product and request technical assistance for the damaged parts. The warranty covers all parts, parts and components that may eventually present a manufacturing defect within a period of 03 (three) months, counting from the delivery of the product to the consumer, by means of a purchase invoice. If there is any change in the structure of the product or defect occurs due to negligence of the assembler/consumer in relation to the assembly and handling instruction, free technical assistance will not be provided.

## ACESSÓRIOS | ACCESORIOS | ACCESSORIES

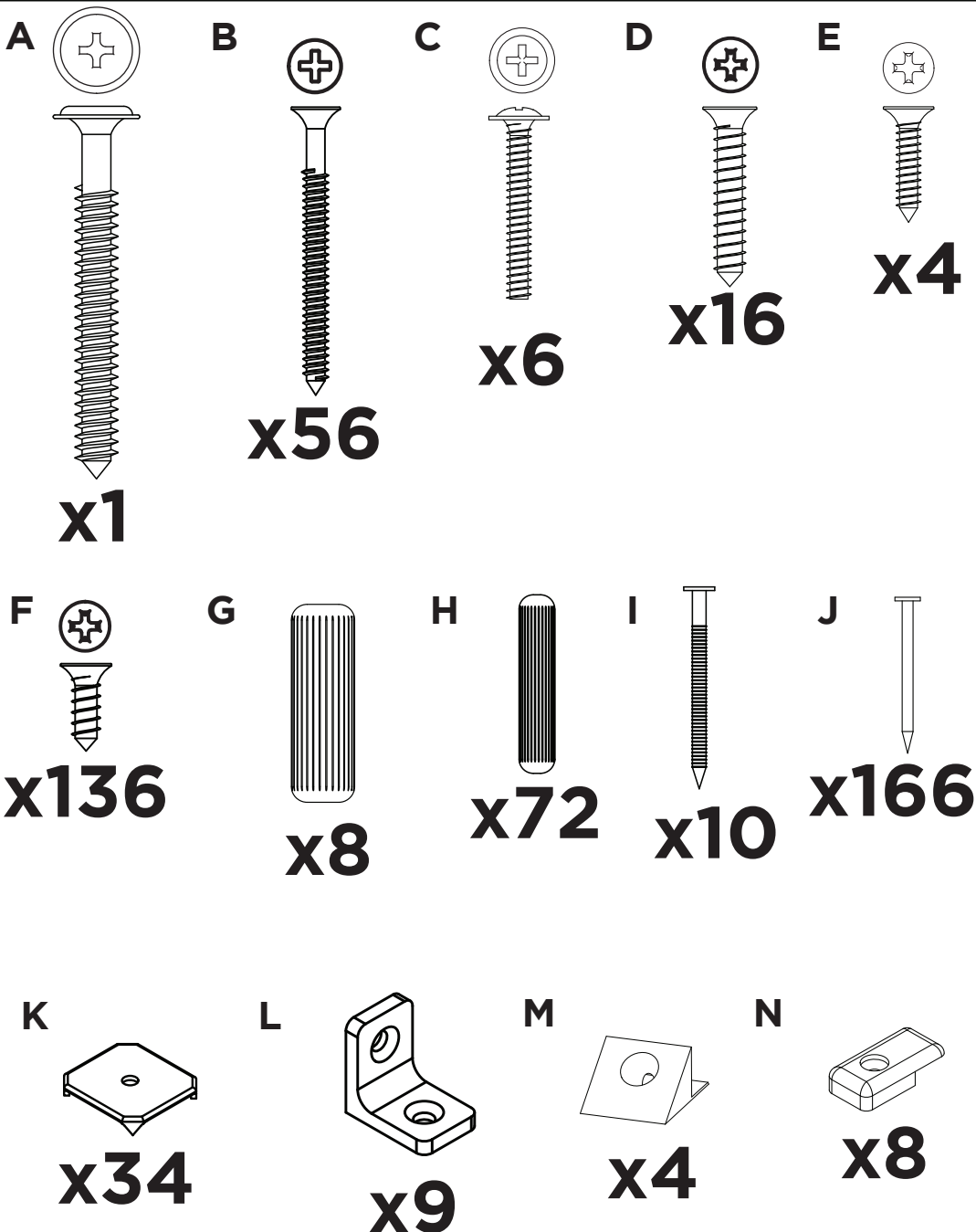

## ACESSÓRIOS | ACCESORIOS | ACCESSORIES

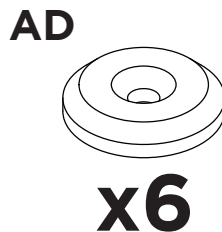
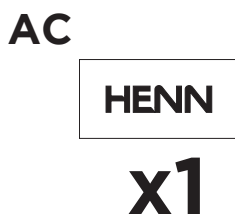
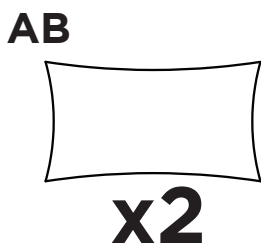
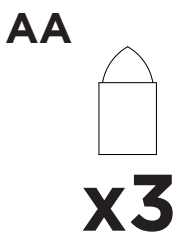
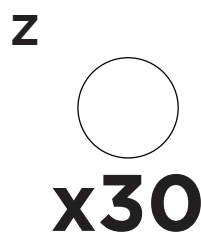
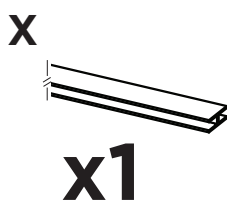
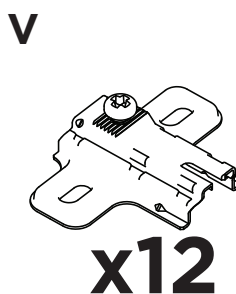
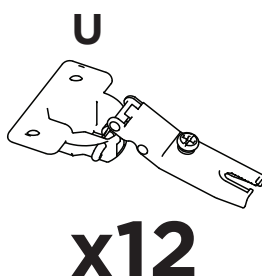
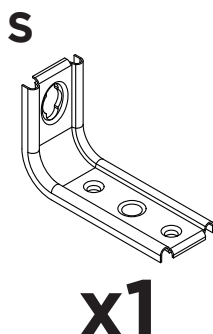
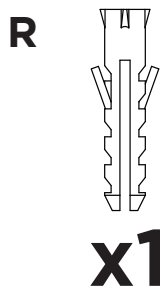
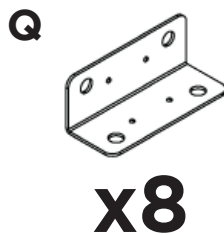
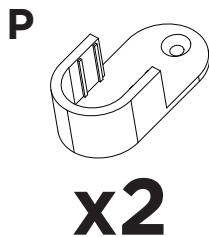
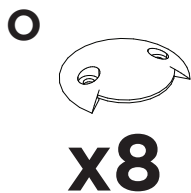

# LISTA DE PEÇAS | LISTA DE PIEZAS | LIST OF PIECES

| Item | Caixa<br>Caja<br>Box | Qty<br>Ctd<br>Qty | Descrição<br>Descripción<br>Description                     | Dimensões (mm)   Dimensiones<br>(mm)   Dimensions (mm) |                           |                                  |
|------|----------------------|-------------------|---|--|---------------------------|----------------------------------|
|      |                      |                   |   | Comprimento<br>Largo<br>Length                         | Largura<br>Ancho<br>Width | Espessura<br>Grosor<br>Thickness |
| 1    | 1/2                  | 02                | RODAPÉ MAIOR   MÁS GRANDE ZÓCALO   BIGGER PLINTH            | 1356   | 60                        | 15                               |
| 2    | 1/2                  | 02                | RODAPÉ MENOR   ZÓCALO MENOR   LOWER PLINTH                  | 312  | 60                        | 15                               |
| 3    | 1/2                  | 06                | PÉ   PIE   FOOT   | 110  | 50                        | 50                               |
| 4    | 1/2                  | 01                | BASE   BASE   BASE  | 1463   | 420                       | 12                               |
| 5    | 1/2                  | 01                | LATERAL ESQUERDA   LADO IZQUIERDO   LEFT SIDE               | 1866   | 420                       | 12                               |
| 6=12 | 1/2                  | 04                | PRATELEIRA   ESTANTE   SHELF                                | 350  | 350                       | 12                               |
| 7    | 1/2                  | 01                | DIVISÃO ESQUERDA   DIVISIÓN IZQUIERDA   LEFT DIVISION       | 1818   | 420                       | 12                               |
| 8    | 1/2                  | 01                | TAMPO DAS GAVETAS   TAPA DE LOS CAJONES  <br>TOP OF DRAWERS | 714  | 420                       | 12                               |
| 9    | 1/2                  | 01                | PRATELEIRA MAIOR   MÁS GRANDE ESTANTE   BIGGER SHELF        | 714  | 350                       | 12                               |
| 10   | 1/2                  | 01                | DIVISÃO DIREITA   DIVISIÓN DERECHA   RIGHT DIVISION         | 1818   | 420                       | 12                               |
| 11   | 1/2                  | 01                | TAMPO   TAPA   TOP  | 1438   | 420                       | 12                               |
| 12=6 | 2/2                  | 04                | PRATELEIRA   ESTANTE   SHELF                                | 350  | 350                       | 12                               |
| 13   | 1/2                  | 01                | LATERAL DIREITA   LADO DERECHO   RIGHT SIDE                 | 1866   | 420                       | 12                               |
| 14   | 1/2                  | 01                | CHAPÉU   SOMBRERO   HAT                                     | 1460   | 40                        | 15                               |
| 15   | 2/2                  | 04                | FUNDO   FONDO   BOTTOM                                      | 1842   | 363                       | 3                                |
| 16   | 2/2                  | 02                | PORTA   PUERTA   DOOR                                       | 1826   | 360                       | 15                               |
| 17   | 2/2                  | 01                | PORTA ESQUERDA   PUERTA IZQUIERDA   LEFT DOOR               | 1378   | 360                       | 15                               |
| 18   | 2/2                  | 01                | PORTA DIREITA   PUERTA DERECHA   RIGHT DOOR                 | 1378   | 360                       | 15                               |
| 19   | 2/2                  | 02                | VIDRO   VIDRIO   GLASS                                      | 660  | 160                       | 3                                |
| 20   | 1/2                  | 02                | MOLDURA LATERAL   MARCO LATERAL   SIDE FRAME                | 384  | 50                        | 12                               |
| 21   | 1/2                  | 01                | MOLDURA FRONTAL   MARCO FRONTAL   FRONT FRAME               | 1500   | 60                        | 12                               |
| 22   | 1/2                  | 02                | FRENTE DE GAVETA   FRENTE DEL CAJÓN   DRAWER FRONT          | 723  | 220                       | 15                               |
| 23   | 1/2                  | 04                | LADO DE GAVETA   LATERAL DEL CAJÓN   DRAWER SIDE            | 350  | 110                       | 12                               |
| 24   | 1/2                  | 02                | FUNDO DE GAVETA   FONDO DEL CAJÓN   DRAWER BOTTOM           | 676  | 361                       | 3                                |
| 25   | 2/2                  | 02                | RIPA DE TRÁS   TRAVESAÑO TRASERO   REAR CLAPBOARD           | 689  | 110                       | 12                               |

## LISTA DE PEÇAS | LISTA DE PIEZAS | LIST OF PIECES

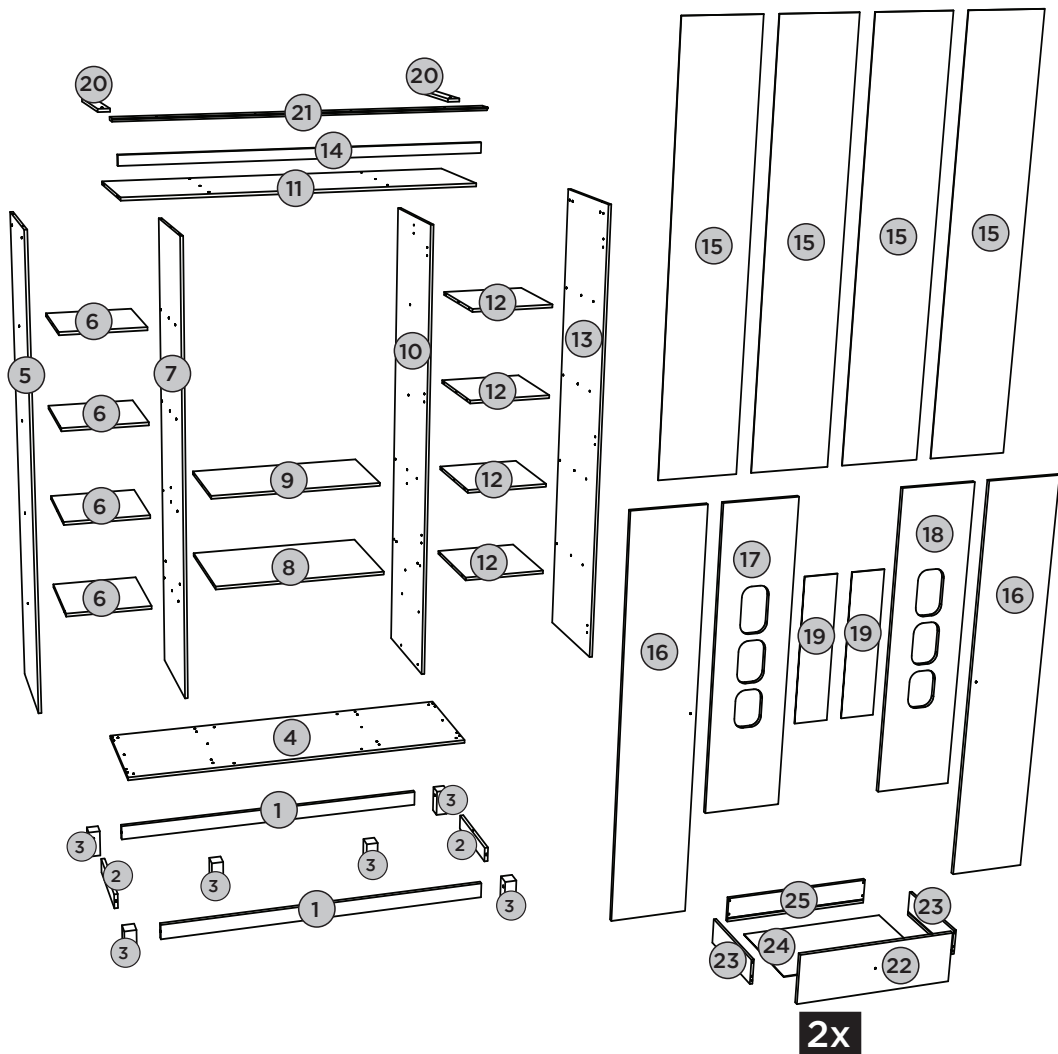





# PASSO 1

ITM/I129-

## PEÇAS REQUERIDAS

|   |              |    |
|---|--------------|----|
| 1 | RODAPÉ MAIOR | x2 |
| 2 | RODAPÉ MENOR | x2 |
| 3 | PÉ           | x6 |

## ACESSÓRIOS REQUERIDOS

|    |   |    |
|----|---|----|
| G  |  | 08 |
| I  |  | 06 |
| AB |  |    |
| AD |  | 06 |

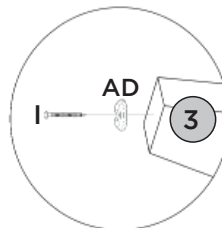
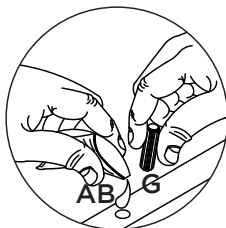
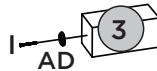
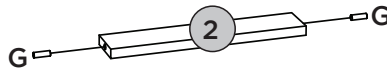
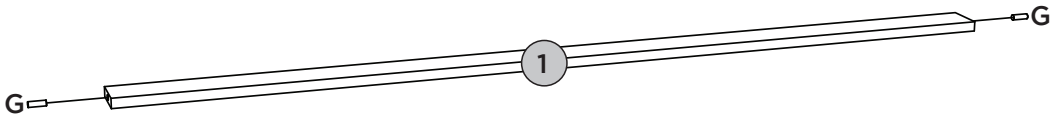
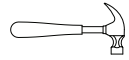

## FERRAMENTAS NECESSÁRIAS



## PEÇAS REQUERIDAS

|      |                   |    |
|------|-------------------|----|
| 6=12 | PRATELEIRA        | x8 |
| 8    | TAMPO DAS GAVETAS | x1 |
| 9    | PRATELEIRA MAIOR  | x1 |
| 11   | TAMPO             | x1 |

## ACESSÓRIOS REQUERIDOS

|    |   |    |
|----|---|----|
| H  |  | 44 |
| AB |  |    |

## FERRAMENTAS NECESSÁRIAS

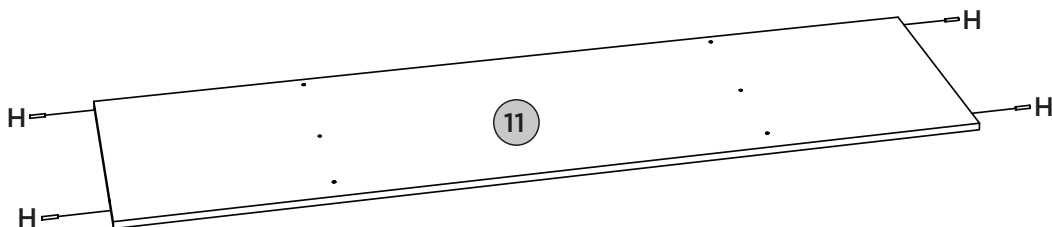
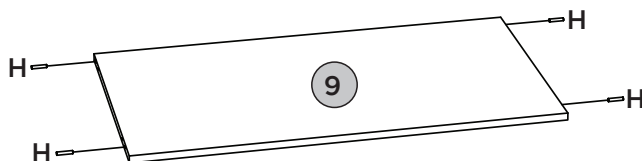
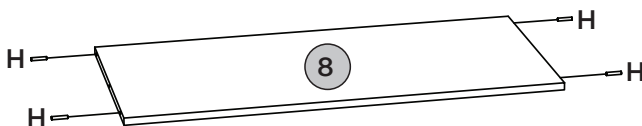
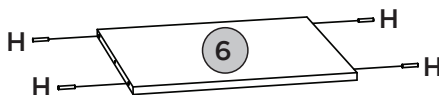
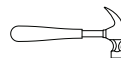







## PASSO 3

## PEÇAS REQUERIDAS

|    |                  |    |
|----|------------------|----|
| 5  | LATERAL ESQUERDA | x1 |
| 7  | DIVISÃO ESQUERDA | x1 |
| 10 | DIVISÃO DIREITA  | x1 |
| 13 | LATERAL DIREITA  | x1 |

## ACESSÓRIOS REQUERIDOS

|    |   |    |
|----|---|----|
| F  |  | 40 |
| H  |  | 12 |
| P  |  | 02 |
| V  |  | 12 |
| W  |  | 02 |
| AB |  |    |

## FERRAMENTAS NECESSÁRIAS

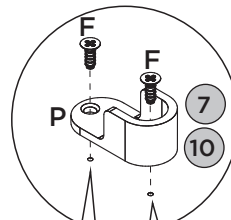
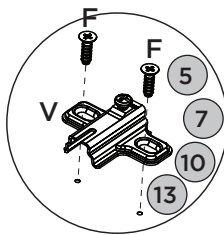
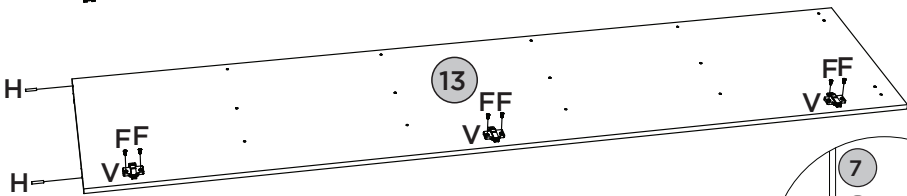
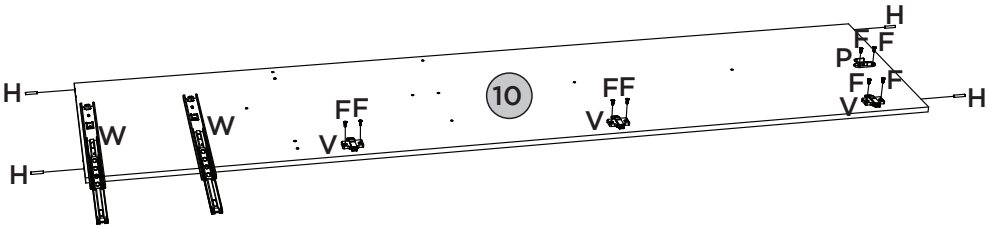
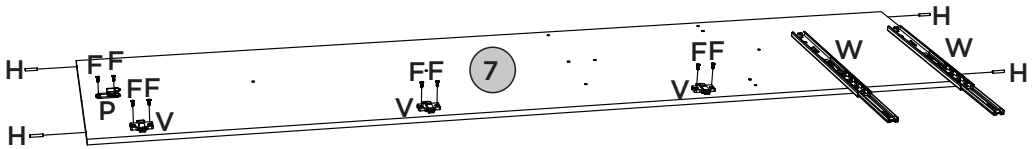
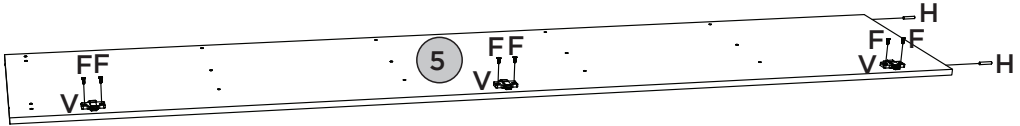
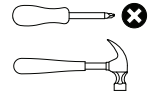

Observe:  
Furos  
pré-marcados

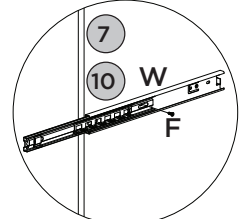
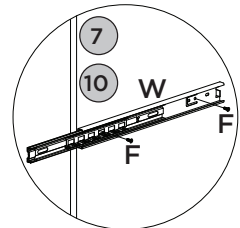







# PASSO 4

ITM/1129-

## PEÇAS REQUERIDAS

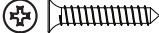
|   |              |    |
|---|--------------|----|
| 1 | RODAPÉ MAIOR | x2 |
| 2 | RODAPÉ MENOR | x2 |
| 3 | PÉ           | x4 |

## ACESSÓRIOS REQUERIDOS

|    |   |    |
|----|---|----|
| D  |  | 16 |
| F  |  | 16 |
| Q  |  | 08 |
| AB |  |    |

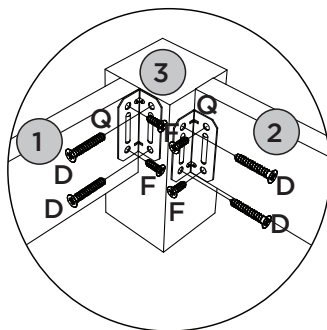
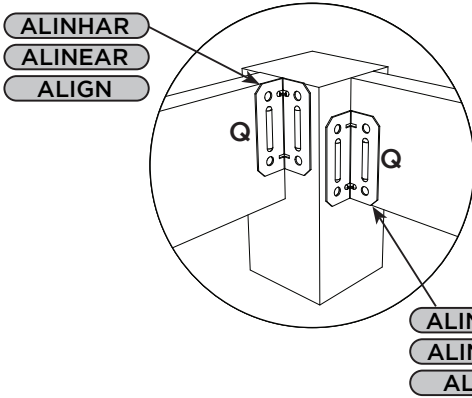
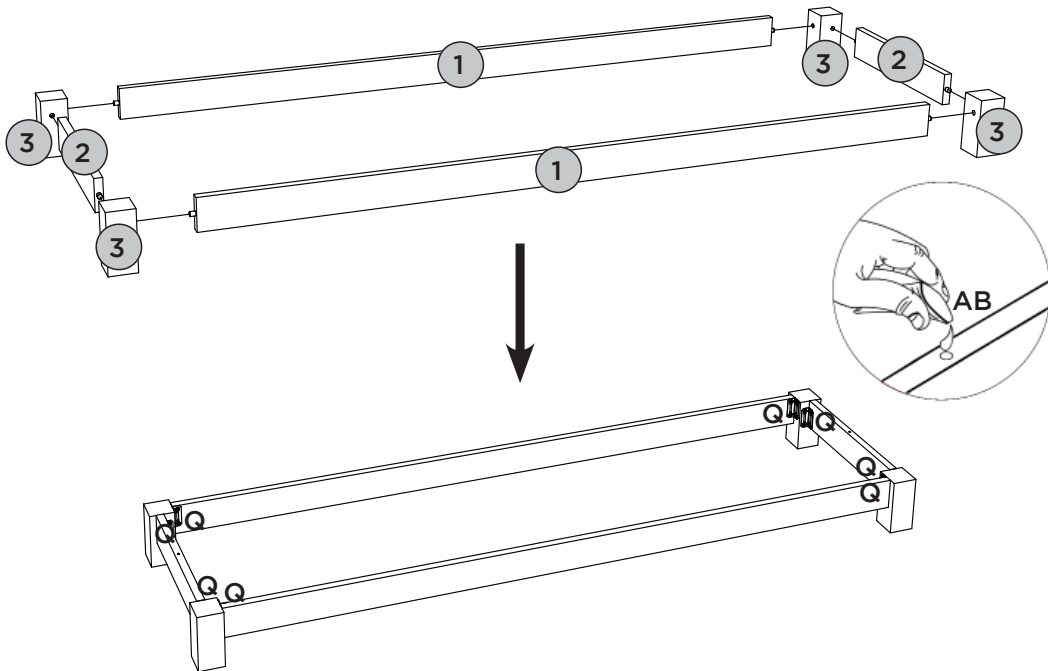
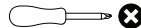

## FERRAMENTAS NECESSÁRIAS



**PASSO 5****PEÇAS REQUERIDAS**

|   |                  |    |
|---|------------------|----|
| 3 | PÉ               | x2 |
| 4 | BASE             | x1 |
| 5 | LATERAL ESQUERDA | x1 |
| 6 | PRATELEIRA       | x4 |
| 7 | DIVISÃO ESQUERDA | x1 |

**ACESSÓRIOS REQUERIDOS**

|    |   |    |
|----|---|----|
| B  |  | 14 |
| AB |  |    |

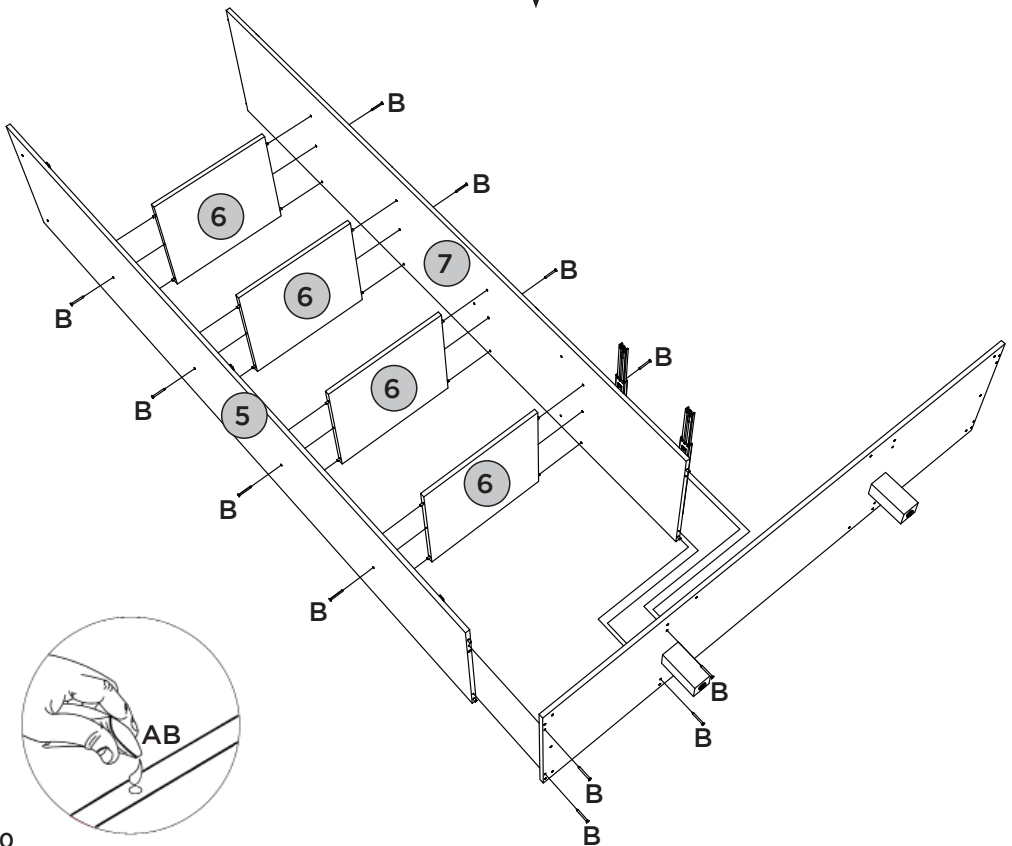
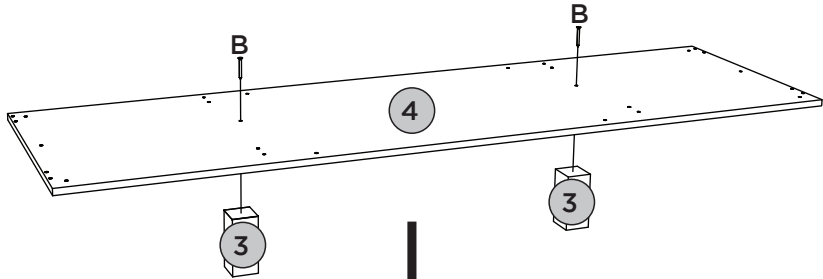
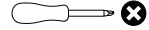
**FERRAMENTAS NECESSÁRIAS**



# PASSO 6

ITM/1129-

## PEÇAS REQUERIDAS

|    |                   |    |
|----|-------------------|----|
| 8  | TAMPO DAS GAVETAS | x1 |
| 9  | PRATELEIRA MAIOR  | x1 |
| 10 | DIVISÃO DIREITA   | x1 |
| 11 | TAMPO             | x1 |

## ACESSÓRIOS REQUERIDOS

|    |   |    |
|----|---|----|
| B  |  | 12 |
| AB |  |    |

## FERRAMENTAS NECESSÁRIAS

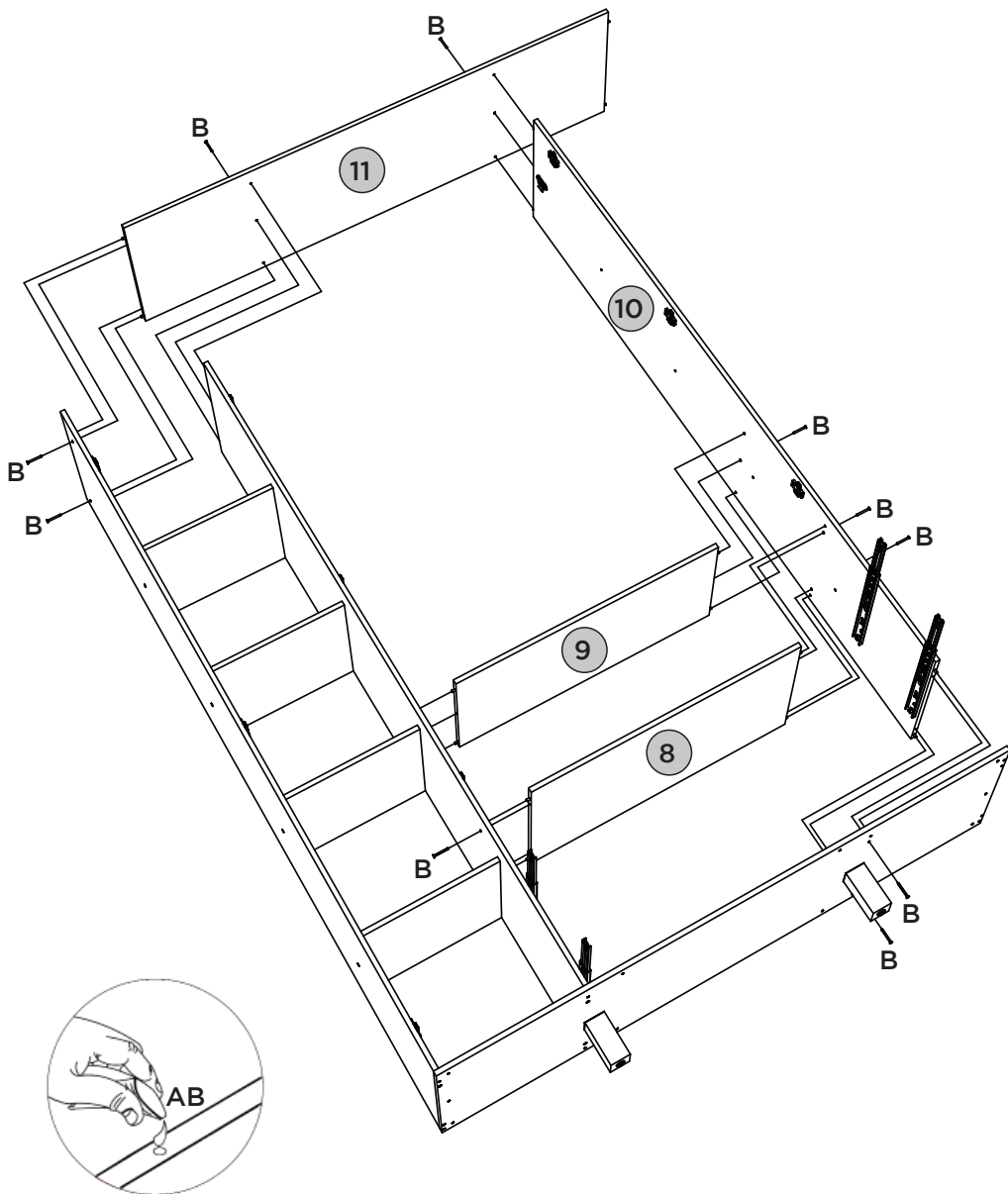
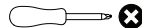



# PASSO 7

ITM/1129-

## PEÇAS REQUERIDAS

|      |                 |    |
|------|-----------------|----|
| 12=6 | PRATELEIRA      | x4 |
| 13   | LATERAL DIREITA | x1 |

## ACESSÓRIOS REQUERIDOS

|    |   |    |
|----|---|----|
| B  |   | 12 |
| AB |  |    |

## FERRAMENTAS NECESSÁRIAS

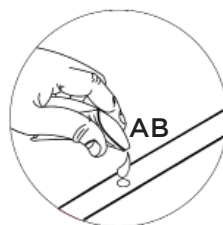
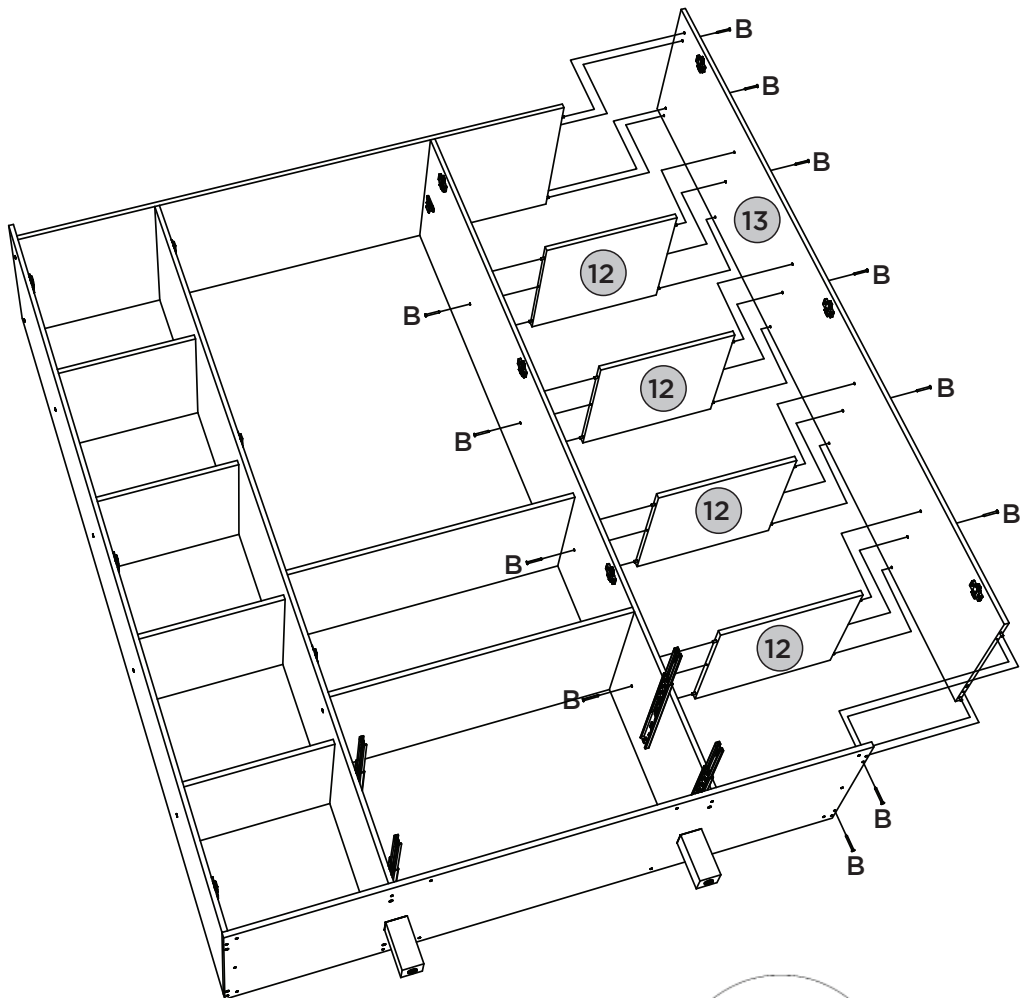
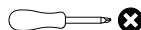

ACESSÓRIOS REQUERIDOS

FERRAMENTAS NECESSÁRIAS

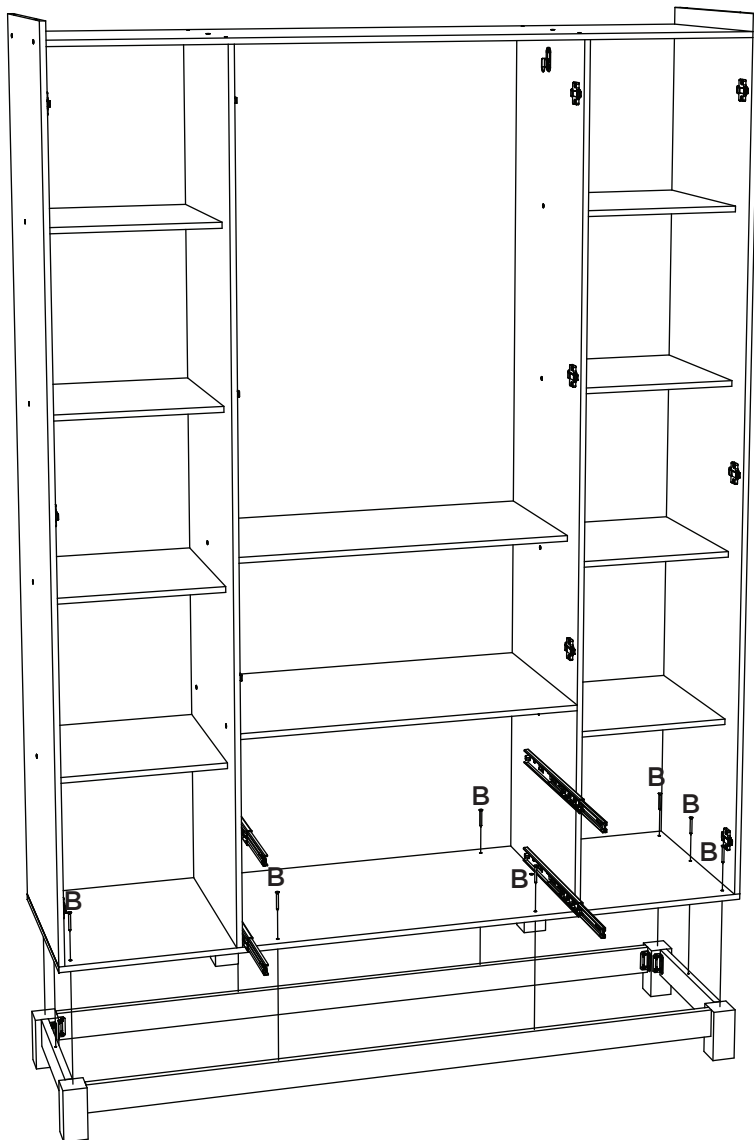
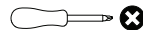
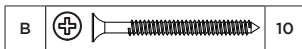





# PASSO 9

ITM/I129-

## PEÇAS REQUERIDAS

|    |        |    |
|----|--------|----|
| 14 | CHAPÉU | x1 |
| 15 | FUNDO  | x4 |

## ACESSÓRIOS REQUERIDOS

|   |   |     |
|---|---|-----|
| F |  | 10  |
| J |  | 166 |
| K |  | 34  |
| L |  | 05  |
| X |  | 01  |



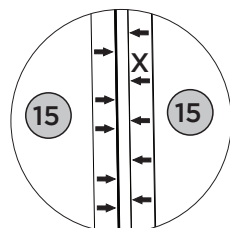
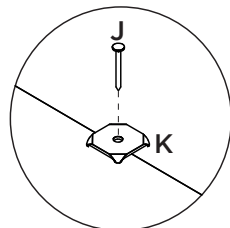
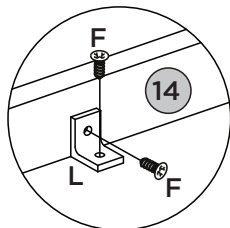
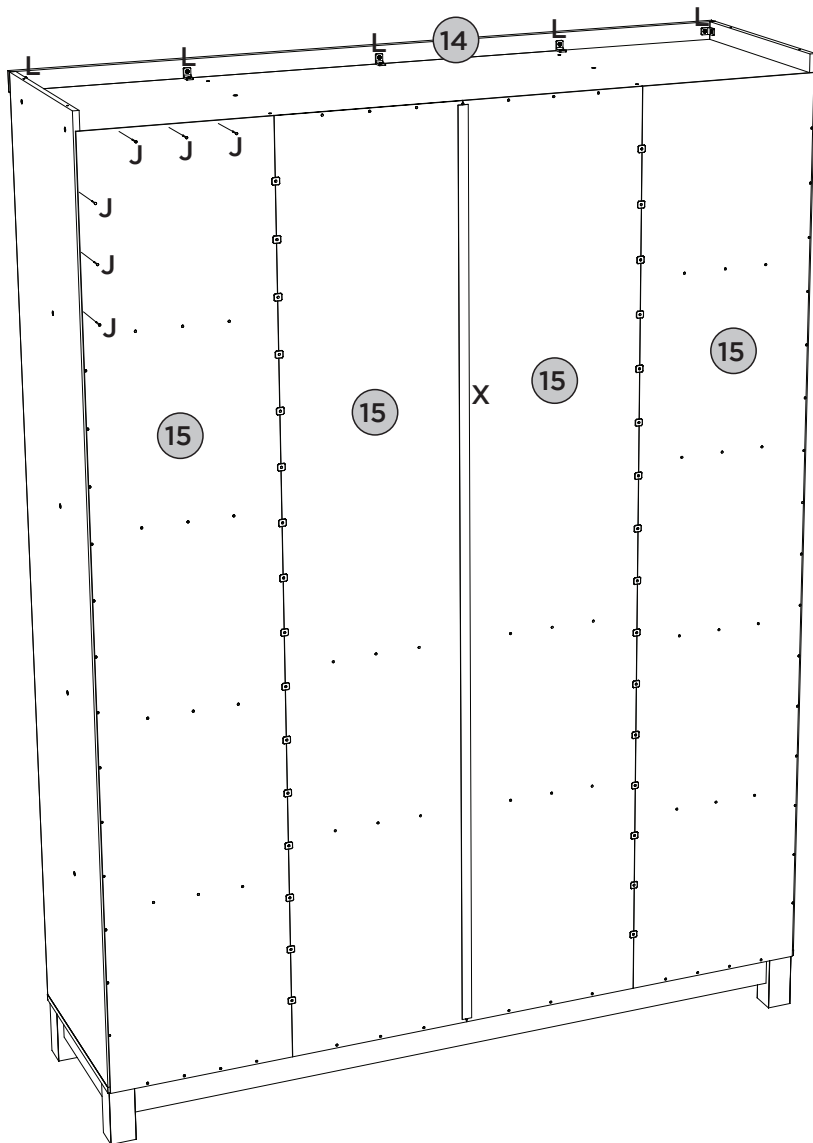
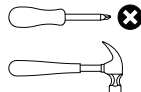

## FERRAMENTAS NECESSÁRIAS

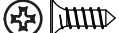

## PEÇAS REQUERIDAS

|    |                |    |
|----|----------------|----|
| 16 | PORTA          | x2 |
| 17 | PORTA ESQUERDA | x1 |
| 18 | PORTA DIREITA  | x1 |
| 19 | VIDRO          | x2 |

## ACESSÓRIOS REQUERIDOS

|   |   |    |
|---|---|----|
| F |  | 48 |
| N |  | 08 |
| O |  | 08 |
| U |  | 12 |

## FERRAMENTAS NECESSÁRIAS

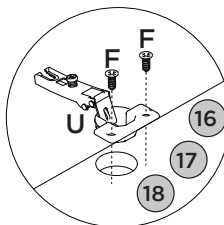
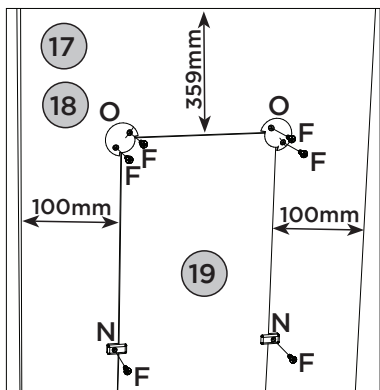
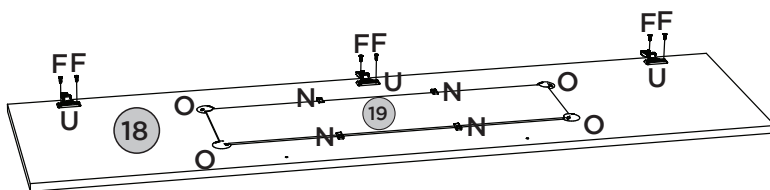
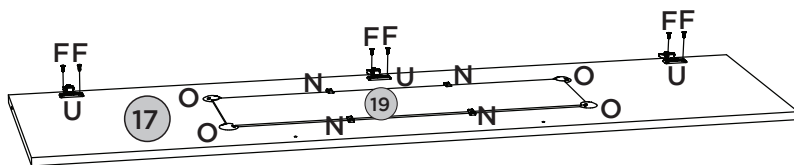
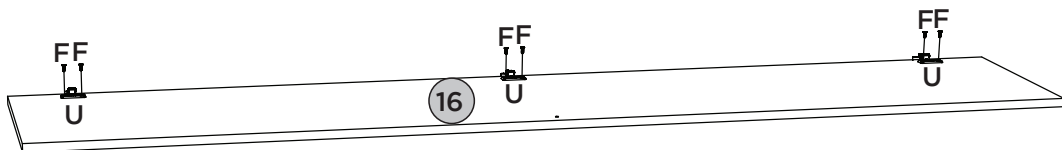
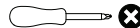

Vídeo: Instalar e regular Dobradiças





Vídeo: Instale y ajuste las bisagras

Vídeo: Install and adjust hinges

## PEÇAS REQUERIDAS

|    |                 |    |
|----|-----------------|----|
| 16 | PORTA           | x2 |
| 17 | PORTA ESQUERDA  | x1 |
| 18 | PORTA DIREITA   | x1 |
| 20 | MOLDURA LATERAL | x2 |
| 21 | MOLDURA FRONTAL | x1 |

## ACESSÓRIOS REQUERIDOS

|   |   |    |
|---|---|----|
| B |  | 08 |
| C |  | 04 |
| T |  | 04 |
| Y |  | 01 |

## FERRAMENTAS NECESSÁRIAS

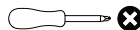

ou:



Usar Torque 15

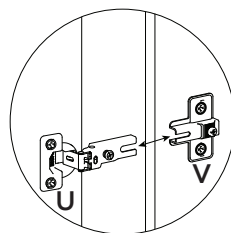
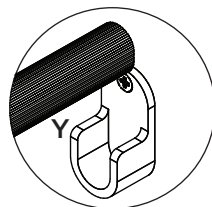
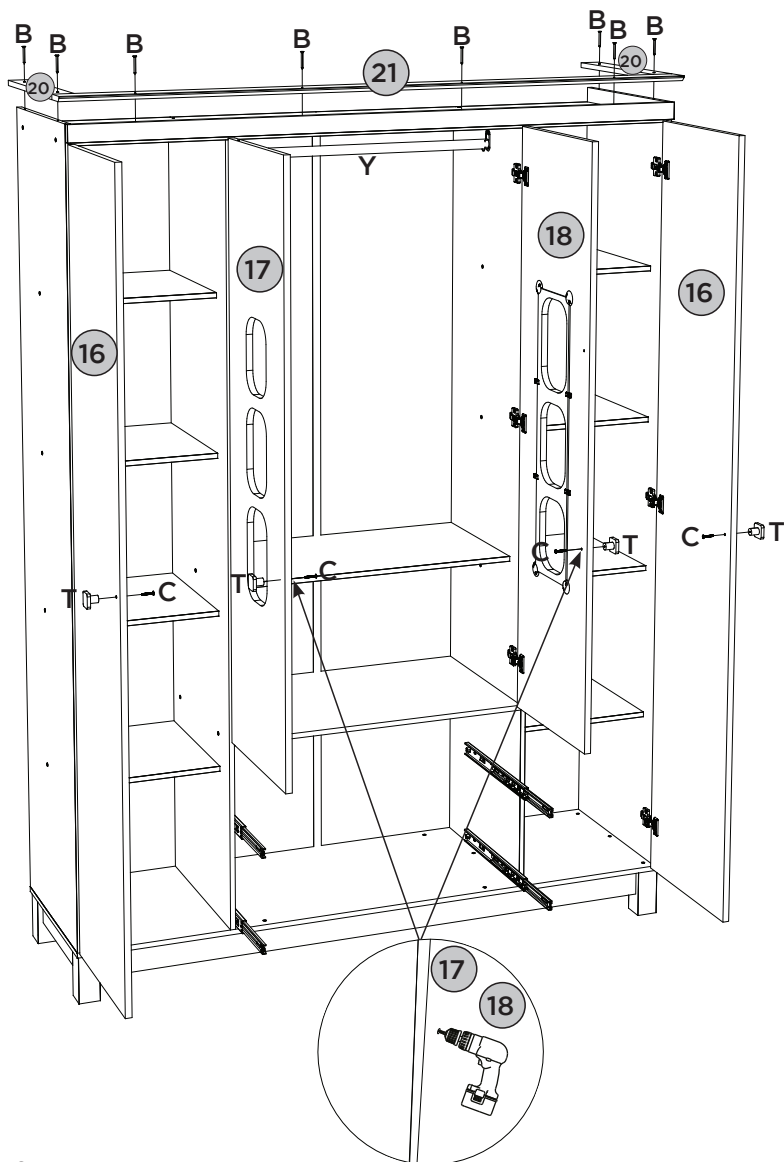

Fazer furação passante para puxador (T) na Porta Esquerda (17), e na Porta Direita (18).

Perforar transeúnte a manija (T) en la Puerta Izquierda (17) y en la Puerta Derecha (18).

Drill passerby to handle (T) on the Left Door (17), and on the Right Door (18).



# PASSO 12

ITM/I129-

## PEÇAS REQUERIDAS

|    |                |    |
|----|----------------|----|
| 23 | LADO DE GAVETA | x4 |
|----|----------------|----|

## ACESSÓRIOS REQUERIDOS

|    |   |    |
|----|---|----|
| H  |  | 16 |
| AB |  |    |

## FERRAMENTAS NECESSÁRIAS

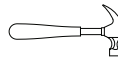
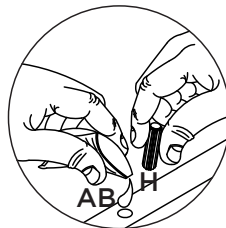
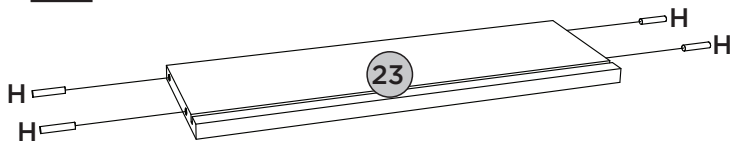

**4x**

# PASSO 13

## PEÇAS REQUERIDAS

|    |                  |    |
|----|------------------|----|
| 22 | FRENTE DE GAVETA | x2 |
| 23 | LADO DE GAVETA   | x4 |
| 24 | FUNDO DE GAVETA  | x2 |

## ACESSÓRIOS REQUERIDOS

|    |   |    |
|----|---|----|
| F  |  | 08 |
| L  |  | 04 |
| AB |  |    |

## FERRAMENTAS NECESSÁRIAS

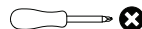
**2x**

1º

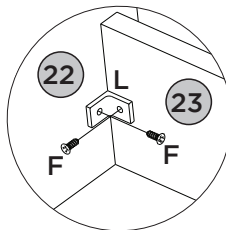
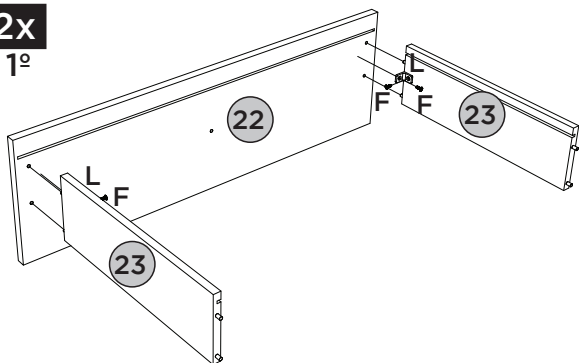
**2x**

2º

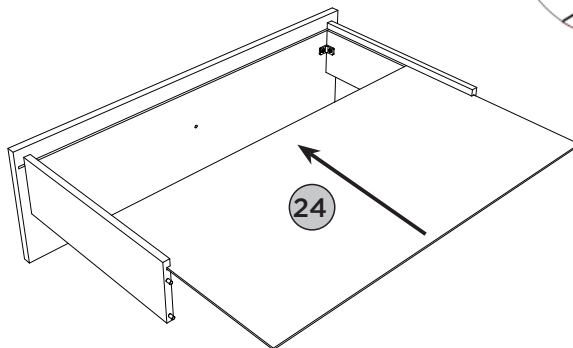
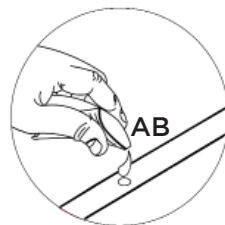
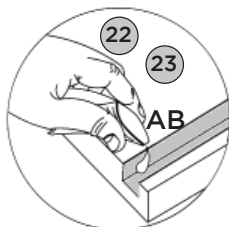

## PEÇAS REQUERIDAS

|    |              |    |
|----|--------------|----|
| 25 | RIPA DE TRÁS | x2 |
|----|--------------|----|

## ACESSÓRIOS REQUERIDOS

|    |  |    |
|----|--|----|
| C  |  | 02 |
| E  |  | 04 |
| F  |  | 12 |
| I  |  | 04 |
| M  |  | 04 |
| T  |  | 02 |
| W  |  | 02 |
| AB |  |    |

## FERRAMENTAS NECESSÁRIAS

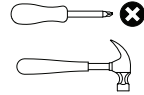

**2x**  
3º

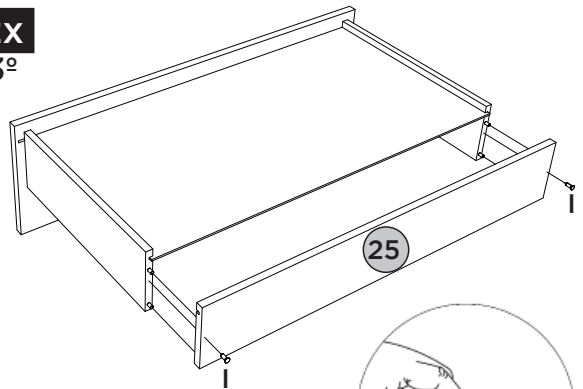
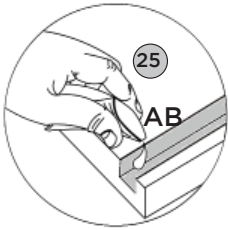

**2x**  
4º

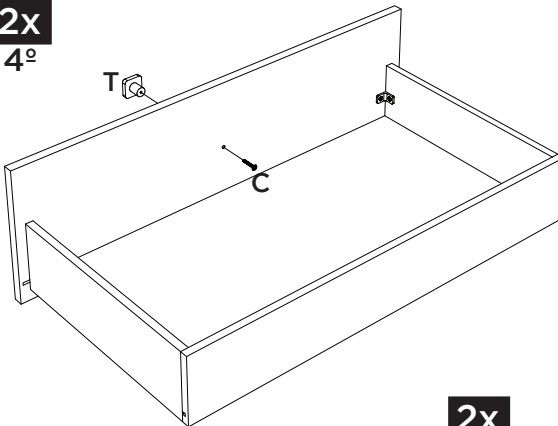

Deixar 3mm de distância da frente de gaveta.





Deje una separación de 3mm del frente del cajón.

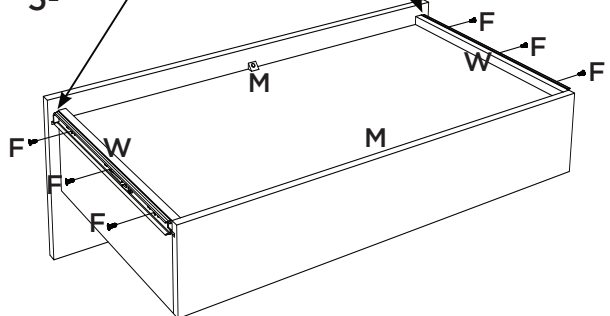
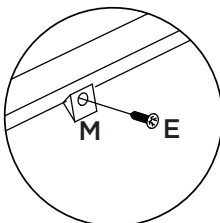

Leave 3mm away from the front of the drawer.

**2x**  
5º



## ACESSÓRIOS REQUERIDOS

|   |   |    |
|---|---|----|
| A |  | 01 |
| F |  | 02 |
| R |  | 01 |
| S |  | 01 |

|    |   |    |
|----|---|----|
| Z  |   | 30 |
| AA |  | 03 |
| AC | <b>HENN</b>   | 01 |

## FERRAMENTAS NECESSÁRIAS

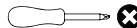

Imprescindível a fixação do produto na parede, a não colocação destas ferragens para fixação (A, F, R e S), poderá permitir que o produto vire, causando acidente.

Es imprescindible la fijación del producto en la pared, la no colocación de estos herrajes para fijación (A, F, R y S, podrá permitir que el El producto se vuelva, causando accidente.

Indispensable to fix the product on the wall, not the placement of these attachment fittings (A, F, R and S may allow the product to turn, causing an accident.

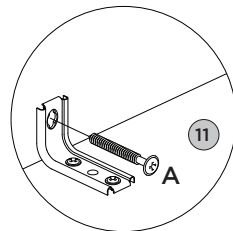
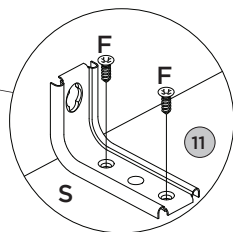
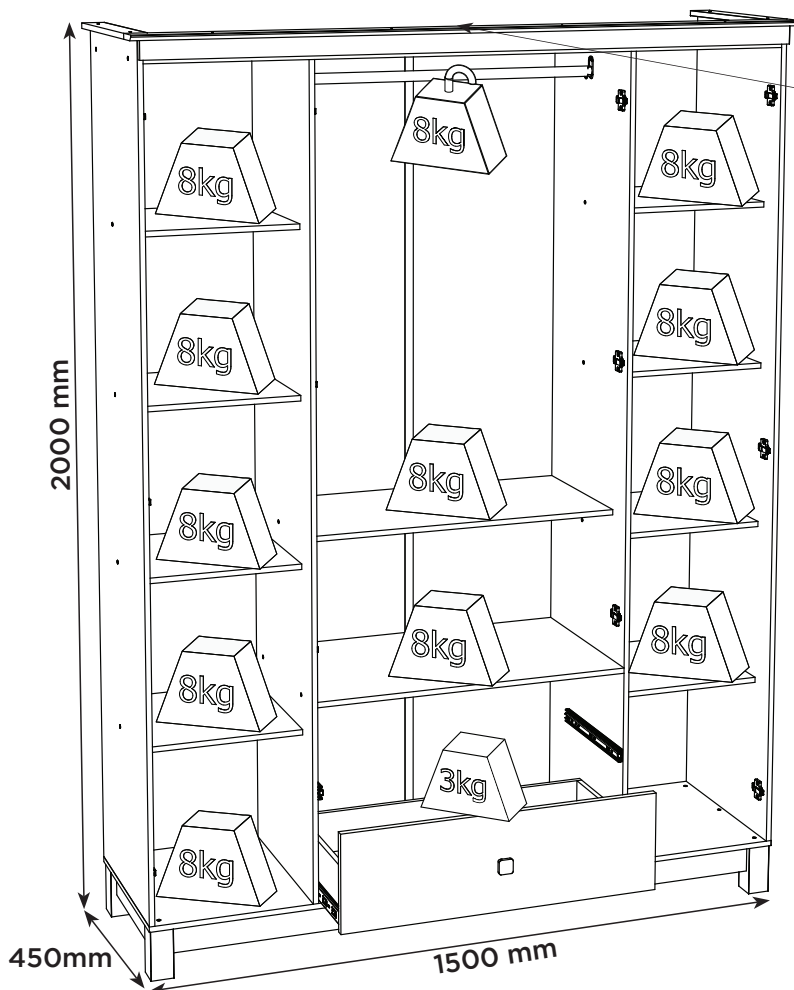

PERFECT CORRECTION  
CORRECCIÓN PERFECTA

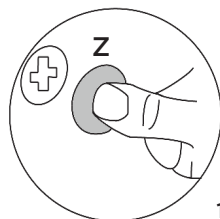
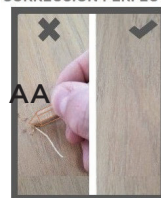

Pesos máximos recomendados com carga distribuída  
Peso máximo recomendado con la carga distribuida  
Recommended maximum weight with distributed load.

Produto Concluído  
Producto terminado  
Finished Product

