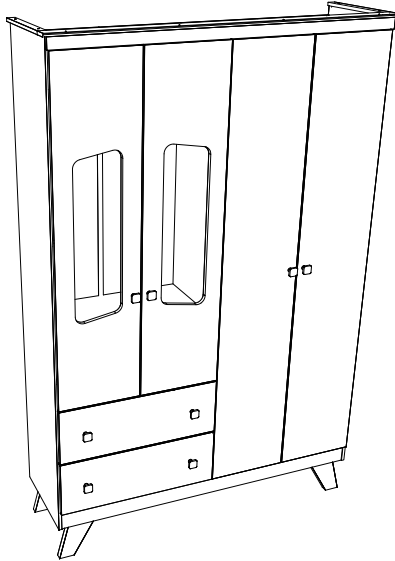
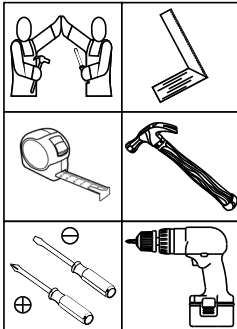

HENNInd. e Com. de Móveis Henn
Mondai - SC - Brasil

☎ +55 49 3674.3500

📧 @moveishenn
www.henn.com.br**INSTRUÇÕES DE
MONTAGEM**INSTRUCCIONES DE MONTAJE
ASSEMBLY INSTRUCTIONS**Roupeiro Confete 4 Portas 2 Gavetas |****Armario Confete 4 Puertas 2 Cajones | Wardrobe Confete 4 Doors 2 Drawers****1125-190 Branco/Jequitibá HP****Requisitos para montagem
Requisitos para la montaje
Assembly Requirements**

Imagens meramente ilustrativas,
não acompanha o produto.
Imágenes ilustrativas, no incluidas
con el producto.
Illustrative images, not included
with the product.

AVISO

Para limpeza de seu móvel, use uma flanela seca ou umedecida, e não utilize produtos químicos que possam danificar seu produto.

SISTEMA DE MONTAGEM

O sistema de montagem dos produtos, funciona de acordo com a ordem crescente dos números indicados no desenho. Ex: 01, 02, 03, 04... até a conclusão da montagem.

ASSISTÊNCIA TÉCNICA

Para solicitação de Assistência Técnica você consumidor deverá entrar em contato com o Lojista o qual você realizou a compra deste produto e solicitar a assistência técnica das peças avariadas. A garantia abrange todas as peças, partes e componentes que eventualmente venham apresentar defeito de fabricação no prazo de 03 (três) meses, contando a partir da entrega do produto ao consumidor, mediante nota fiscal de compra. Se houver qualquer alteração na estrutura do produto ou ocorrer defeito por negligência do montador/consumidor em relação a instrução de montagem e manuseio, não será fornecido assistência técnica gratuita.

ADVERTENCIA

Para limpieza de su móvil, use una flanela seca o húmeda, y no utilice productos químicos que puedan dañar su producto.

SISTEMA DE MONTAJE

El sistema de montaje de los productos funciona de acuerdo con el orden creciente de los números indicados en el dibujo. Ej.: 01, 02, 03, 04... hasta la conclusión del montaje.

ASISTENCIA TÉCNICA

Para solicitar Asistencia Técnica, el consumidor debe comunicarse con el Comercio que usted realizó la compra de este producto y solicita asistencia técnica para las partes dañadas. La garantía cubre todas las partes, piezas y componentes que eventualmente puedan presentar defecto de fabricación en el plazo de 03 (tres) meses, contados a partir de la entrega del producto al consumidor, mediante factura de compra. Si se produce algún cambio en la estructura del producto o se produce un defecto por negligencia del montador/consumidor en relación con las instrucciones de montaje y manipulación, no se prestará asistencia técnica gratuita.

NOTICE

To clean your furniture, use a dry or wet cloth, and do not use chemicals that may damage your product.

ASSEMBLY SYSTEM

The products' assembly system works according to the increasing order of the indicated numbers. For example: 01, 02, 03, 04 ... to the end of the assembly.

TECHNICAL ASSISTANCE

To request Technical Assistance, the consumer must contact the retailer from whom you purchased this product and request technical assistance for the damaged parts. The warranty covers all parts, parts and components that may eventually present a manufacturing defect within a period of 03 (three) months, counting from the delivery of the product to the consumer, by means of a purchase invoice. If there is any change in the structure of the product or defect occurs due to negligence of the assembler/consumer in relation to the assembly and handling instruction, free technical assistance will not be provided.

ACESSÓRIOS | ACCESORIOS | ACCESSORIES

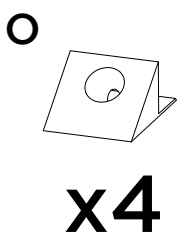
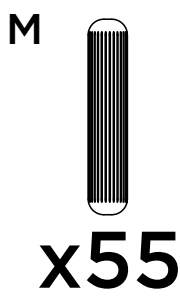
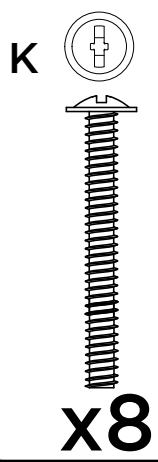
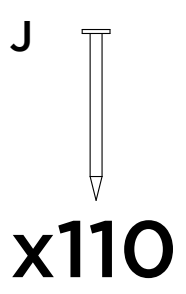
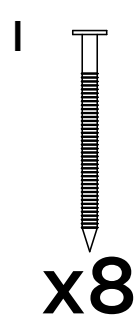
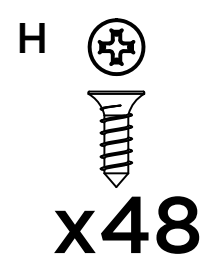
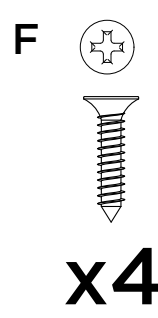
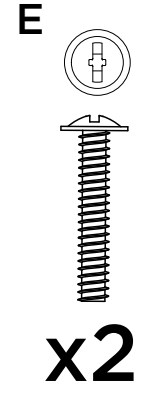
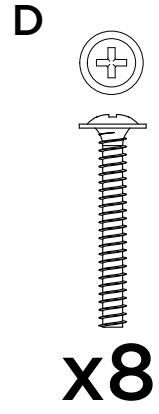
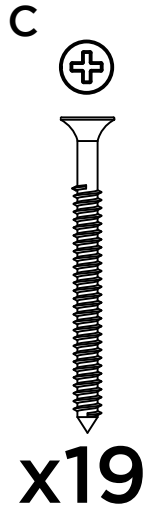
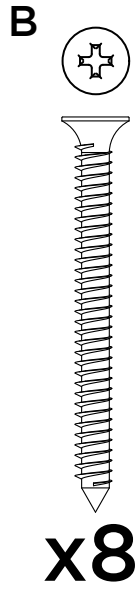
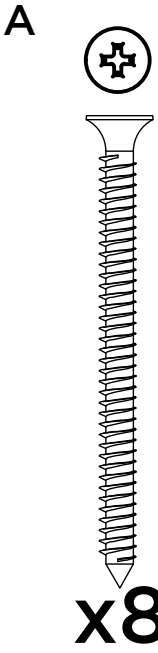

Parafusos em escala
Tornillos escalados
Scaled screws **1:1**

ACESSÓRIOS | ACCESORIOS | ACCESSORIES

P



x2

Q

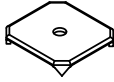

x16

R



x16

S



x8

T

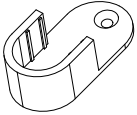

x2

U

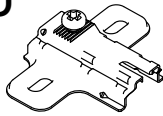

x12

V

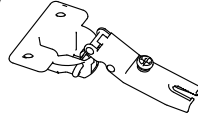

x12

W

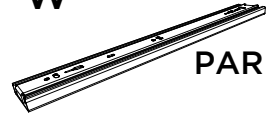

PAR

x2

X



x1

Y



x2

Z

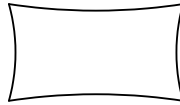

x1

AA

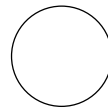

x26

AB

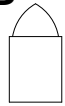

x3

AC



x1

AD

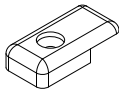

x12

AE



x1

AF

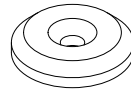

x4

AG



x8

LISTA DE PEÇAS | LISTA DE PIEZAS | LIST OF PIECES ITM/I125-

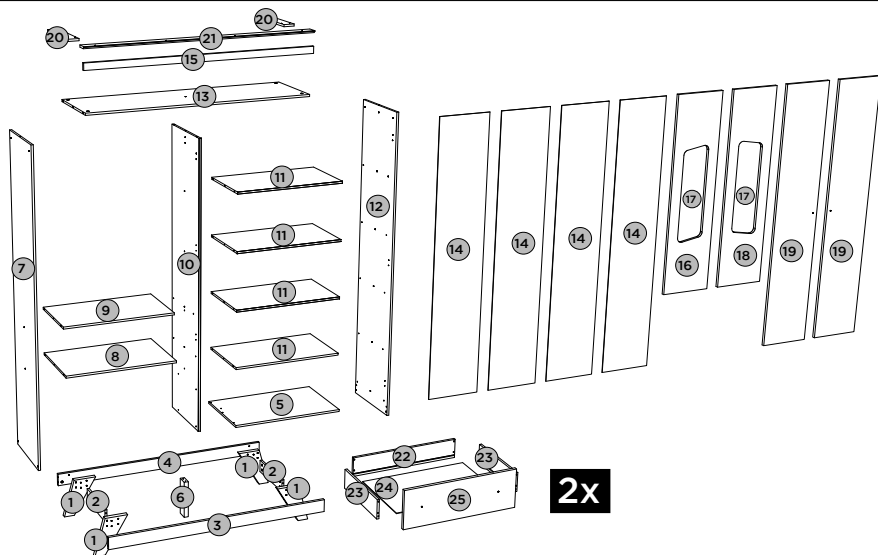

Item	Caixa Caja Box	Qty Ctd Qty	Descrição Descripción Description	Dimensões (mm) Dimensiones (mm) Dimensions (mm)		
				Comprimento Largo Length	Largura Ancho Width	Espessura Grosor Thickness
1	1/2	4	PÉ PIE FOOT	223	191	25
2	1/2	2	TRAVESSA DO RODAPÉ TRAVESAÑO DE PIE DE PÁGINA FOOTER CROSSPIECE	294	73	12
3	1/2	1	RODAPÉ FRONTAL PIE DE PÁGINA FRONTAL FRONT FOOTER	1260	73	15
4	2/2	1	RODAPÉ TRASEIRO PIE DE PÁGINA POSTERIOR REAR FOOTER	1260	73	15
5	1/2	1	BASE BASE BASE	636	380	12
6	1/2	1	PÉ CENTRAL PIE CENTRAL CENTER FOOT	223	60	25
7	1/2	1	LATERAL ESQUERDA LADO IZQUIERDO LEFT SIDE	1835	380	12
8	1/2	1	TAMPO DAS GAVETAS PARTE SUPERIOR DEL CAJÓN DRAWER TOP	624	380	12
9=11	1/2	1	PRATELEIRA ESTANTE SHELF	624	350	12
10	1/2	1	DIVISÃO DIVISIÓN DIVISION	1703	380	12
11=9	1/2	4	PRATELEIRA ESTANTE SHELF	624	350	12
12	1/2	1	LATERAL DIREITA LADO DERECHO RIGHT SIDE	1835	380	12
13	1/2	1	TAMPO CUBRIR COVER	1260	380	12
14	1/2	4	FUNDO FONDO BOTTOM	1727	319	3
15	1/2	1	CHAPÉU SOMBRERO HAT	1282	40	15
16	2/2	1	PORTA ESQUERDA PUERTA IZQUIERDA LEFT DOOR	1269	315	15
17	2/2	2	VIDRO VIDRIO GLASS	650	215	3
18	2/2	1	PORTA DIREITA PUERTA DERECHA RIGHT DOOR	1269	315	15
19	2/2	2	PORTA MAIOR GRAN PUERTA GREAT DOOR	1717	315	15
20	1/2	2	MOLDURA LATERAL MARCO LATERAL SIDE FRAME	344	30	12
21	1/2	1	MOLDURA FRONTAL MARCO FRONTAL FRONT FRAME	1308	60	12
22	1/2	2	RIPA DE TRÁS PORTÁTIL TRASERO BACK LAPTOP	604	110	12
23	1/2	4	LADO DE GAVETA LADO DEL CAJÓN DRAWER SIDE	350	110	12
24	1/2	2	FUNDO DE GAVETA FONDO DE CAJÓN DRAWER BOTTOM	591	361	3
25	2/2	2	FRENTE DE GAVETA FRENTE DE CAJÓN DRAWER FRONT	634	220	15







PASSO 1

ITM/I125-

PEÇAS REQUERIDAS

1	PÉ	x4
2	TRAVESSA DO RODAPÉ	x2
3	RODAPÉ FRONTAL	x1
4	RODAPÉ TRASEIRO	x1
6	PÉ CENTRAL	x1

ACESSÓRIOS REQUERIDOS

I		04
L		08
M		05
R		12
AE		01
AF		04

FERRAMENTAS NECESSÁRIAS

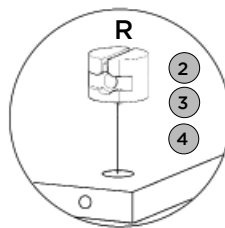
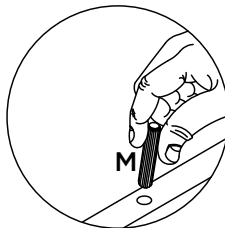
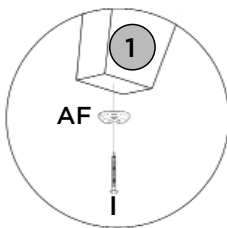
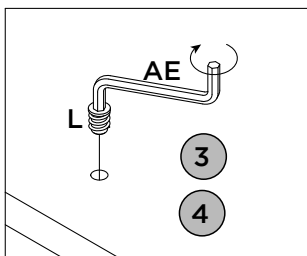
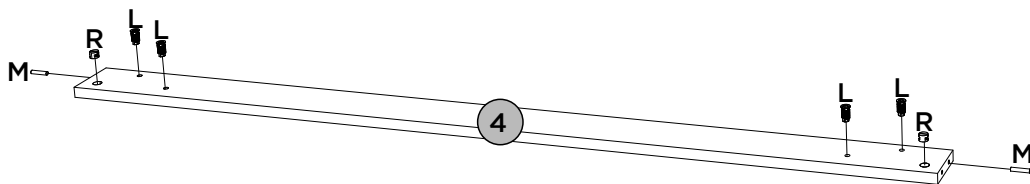
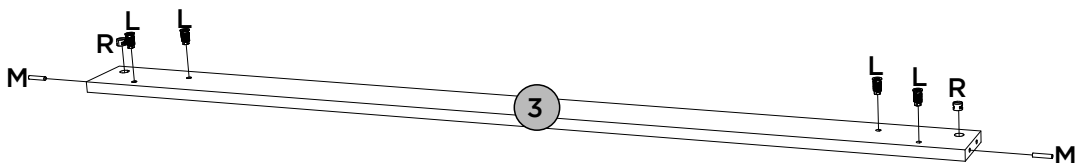
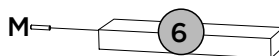
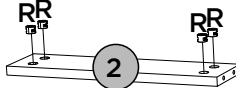
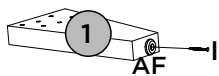
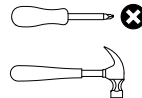

PEÇAS REQUERIDAS

5	BASE	x1
8	TAMPO DAS GAVETAS	x1
9=11	PRATELEIRA	x5

ACESSÓRIOS REQUERIDOS

M		26
---	---	----

FERRAMENTAS NECESSÁRIAS

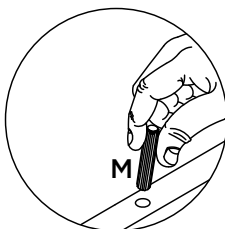
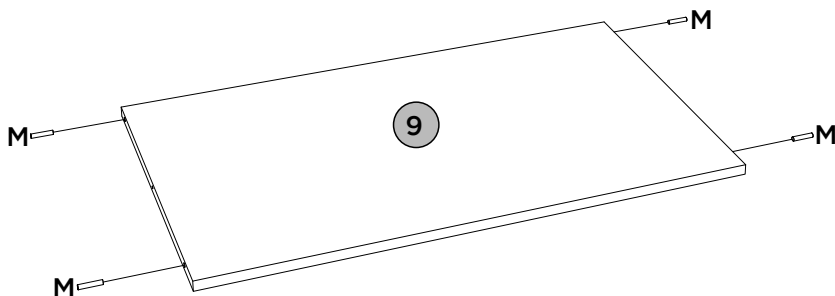
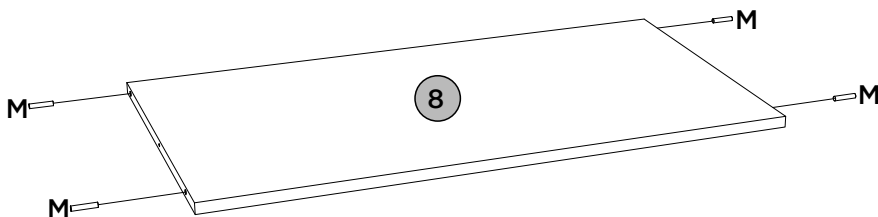
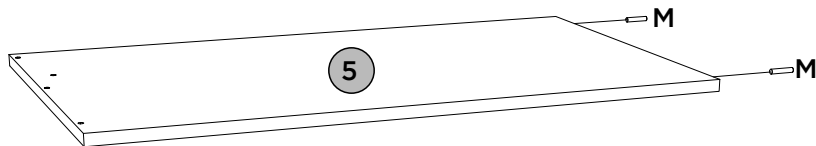
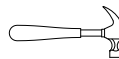

PEÇAS REQUERIDAS

7	LATERAL ESQUERDA	x1
10	DIVISÃO	x1

ACESSÓRIOS REQUERIDOS

G		14
H		16
M		05
T		02
U		07
W		02

FERRAMENTAS NECESSÁRIAS

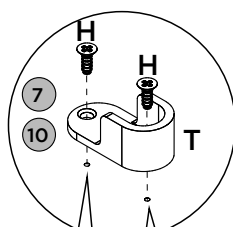
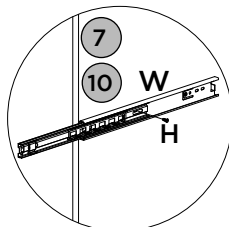
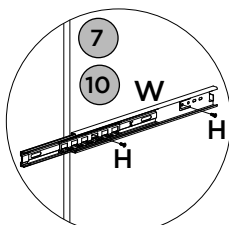
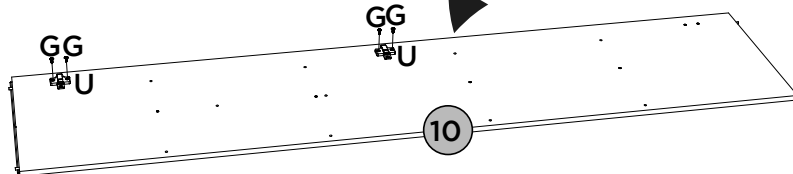
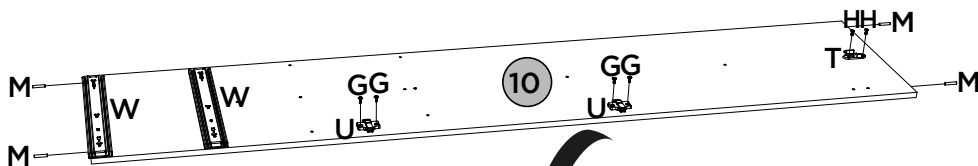
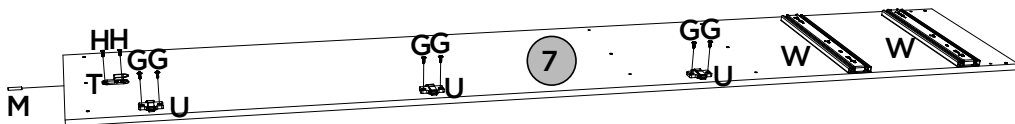
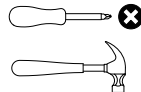

**Observe:
Furos
pré-marcados**

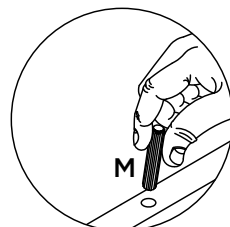
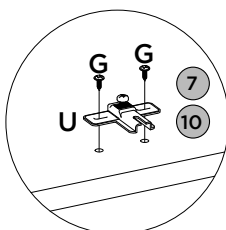





PASSO 4

ITM/I125-

PEÇAS REQUERIDAS

12	LATERAL DIREITA	x1
13	TAMPO	x1

ACESSÓRIOS REQUERIDOS

G		06
M		03
R		04
U		03

FERRAMENTAS NECESSÁRIAS

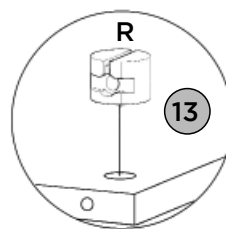
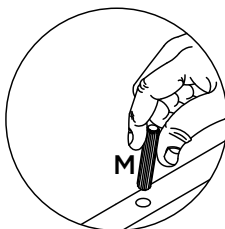
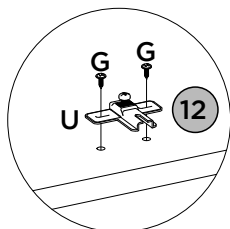
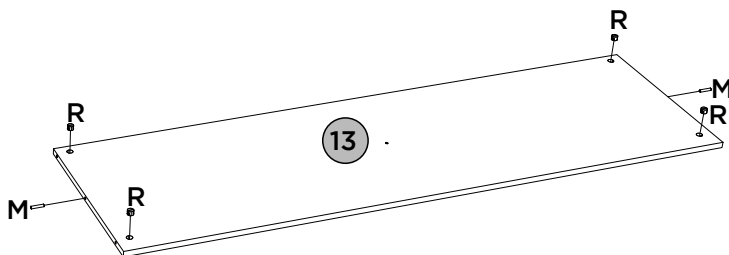
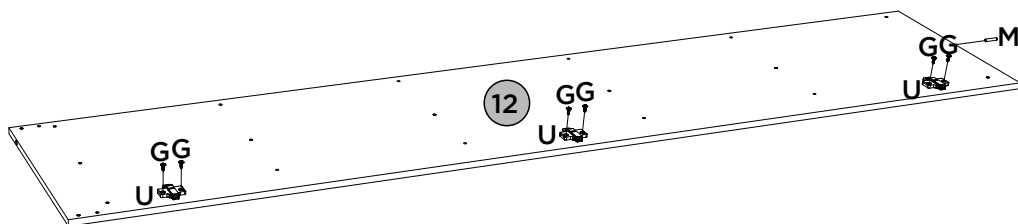
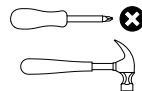

PASSO 5

ITM/1125-

PEÇAS REQUERIDAS

1	PÉ	x4
2	TRAVESSA DO RODAPÉ	x2

ACESSÓRIOS REQUERIDOS



FERRAMENTAS NECESSÁRIAS

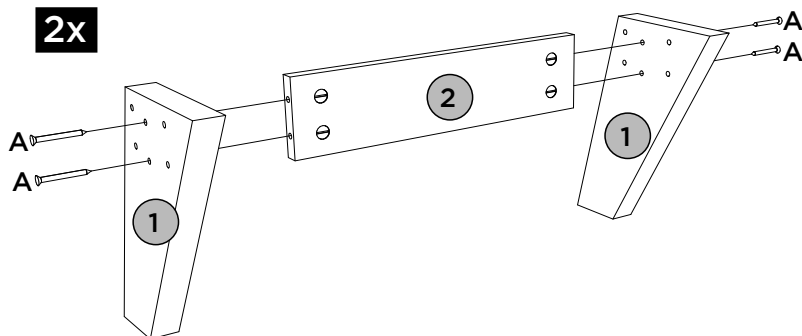
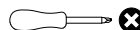

PASSO 6

PEÇAS REQUERIDAS

3	RODAPÉ FRONTAL	x1
4	RODAPÉ TRASEIRO	x1

ACESSÓRIOS REQUERIDOS





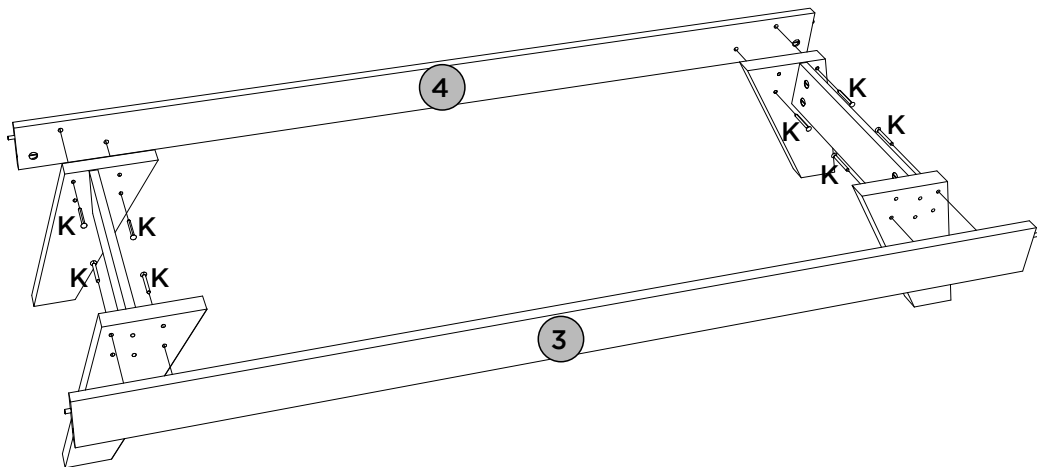
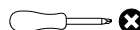

FERRAMENTAS NECESSÁRIAS



PEÇAS REQUERIDAS

5	BASE	x1
6	PÉ CENTRAL	x1
7	LATERAL ESQUERDA	x1

ACESSÓRIOS REQUERIDOS

B		02
C		01
G		04
N		02

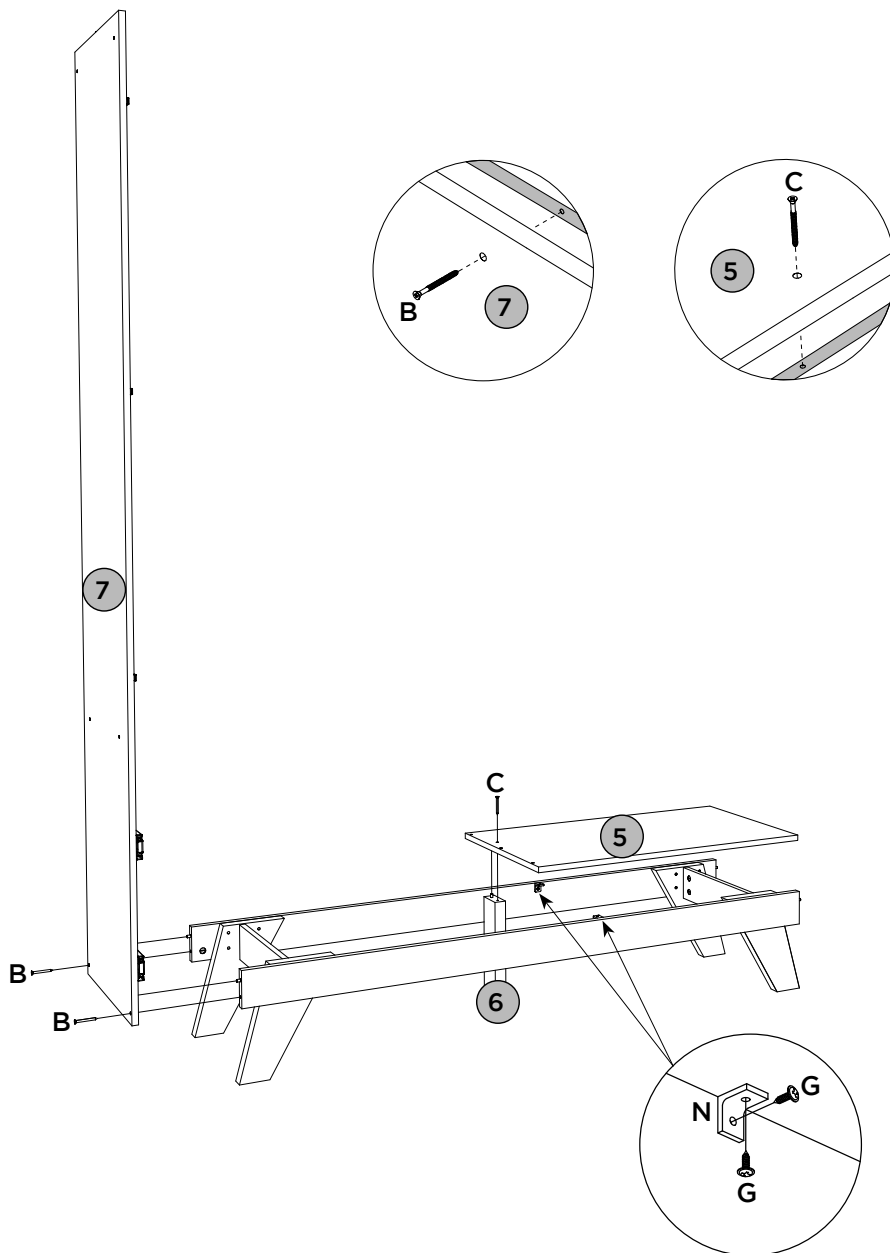
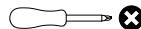
FERRAMENTAS NECESSÁRIAS

PEÇAS REQUERIDAS

8	TAMPO DAS GAVETAS	x1
9=11	PRATELEIRA	x1
10	DIVISÃO	x1

ACESSÓRIOS REQUERIDOS

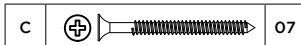



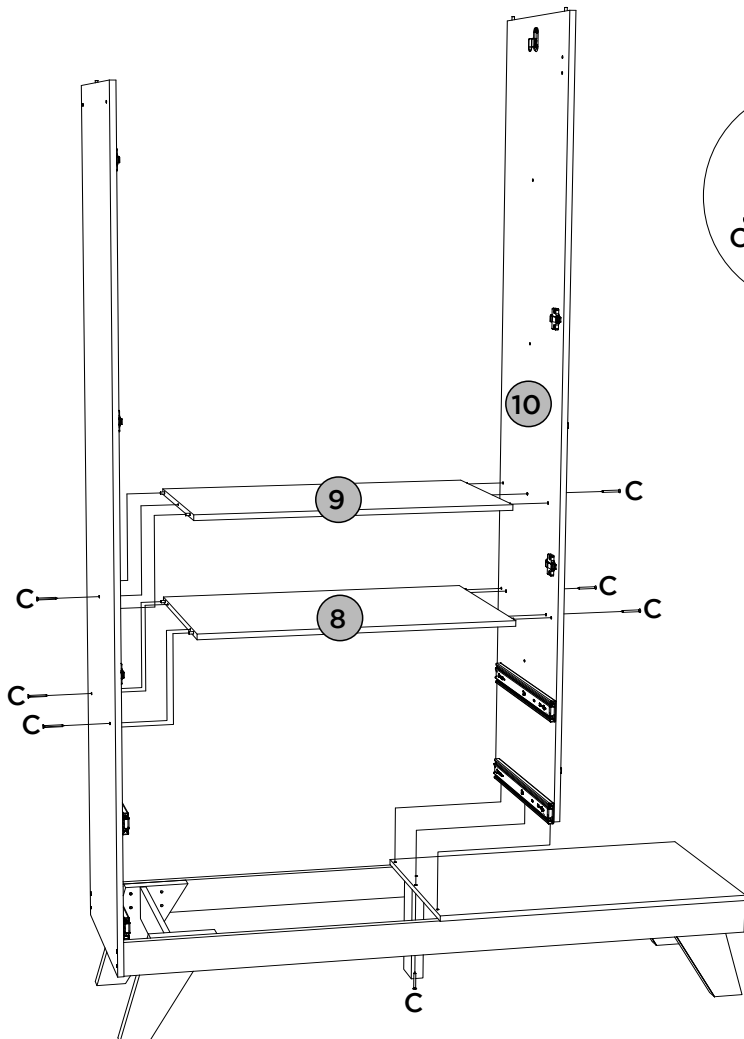
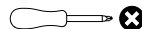

FERRAMENTAS NECESSÁRIAS



PEÇAS REQUERIDAS

11=9	PRATELERIA	x4
12	LATERAL DIREITA	x1
13	TAMPO	x1

ACESSÓRIOS REQUERIDOS

B			06
C			11



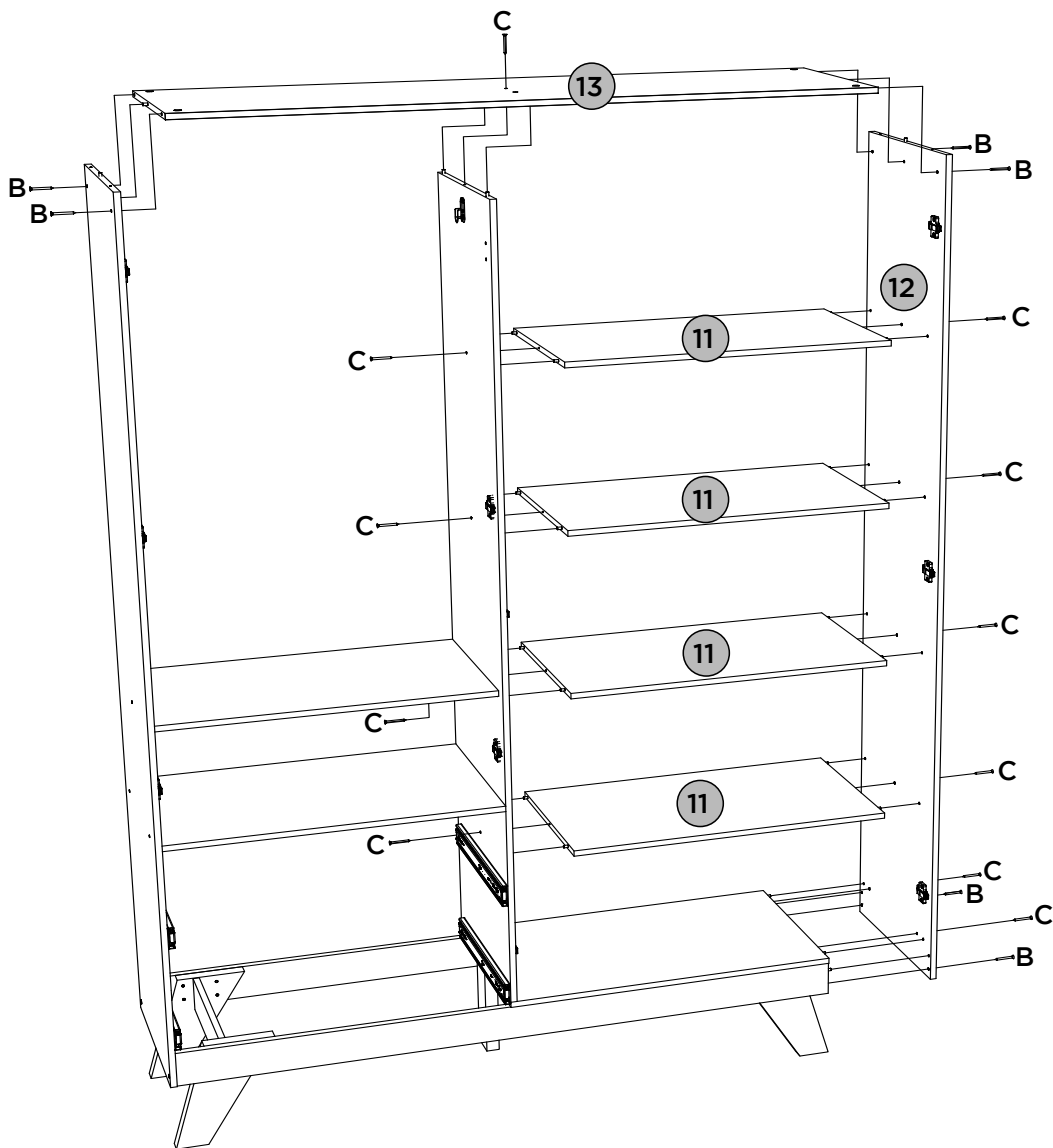
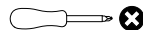

FERRAMENTAS NECESSÁRIAS



PEÇAS REQUERIDAS

14	FUNDO	x4
15	CHAPÉU	x1

ACESSÓRIOS REQUERIDOS

G		10
J		110
N		05
Q		16
Y		02

FERRAMENTAS NECESSÁRIAS

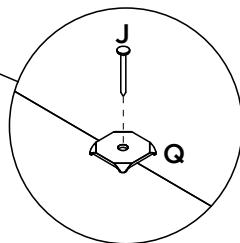
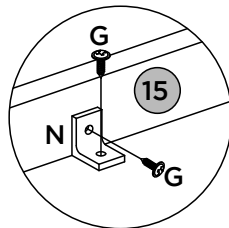
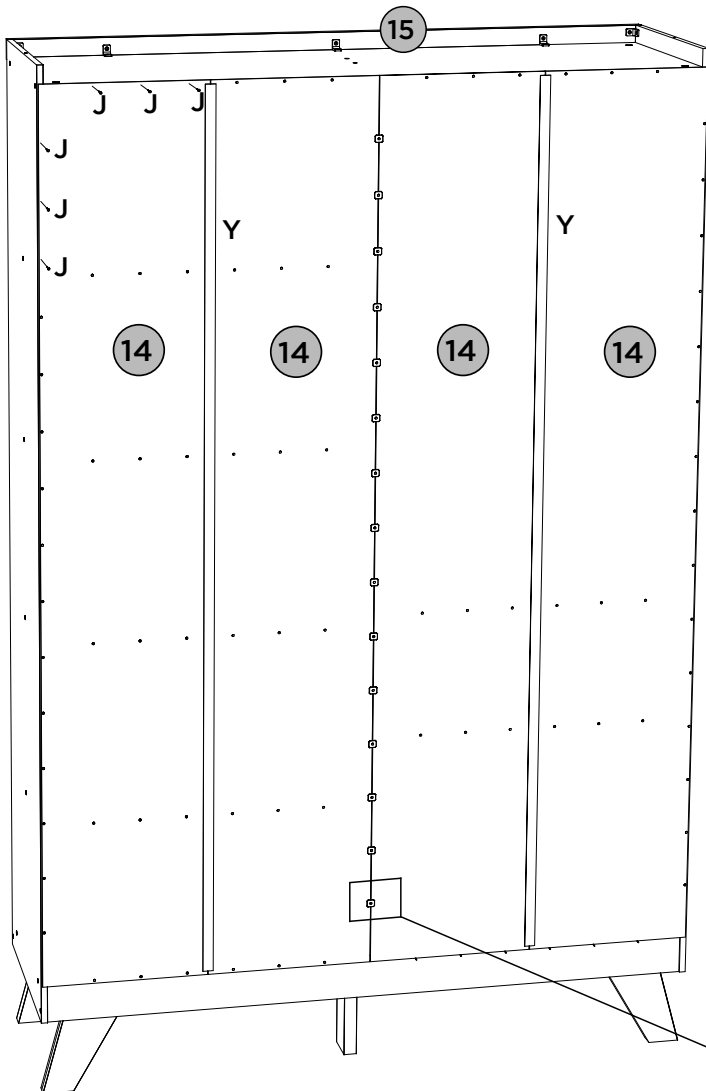
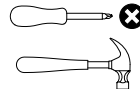

PEÇAS REQUERIDAS

16	PORTA ESQUERDA	x1
17	VIDRO	x2
18	PORTA DIREITA	x1
19	PORTA MAIOR	x2

ACESSÓRIOS REQUERIDOS

D		04
G		24
H		12
S		04
V		12
AD		12

FERRAMENTAS NECESSÁRIAS

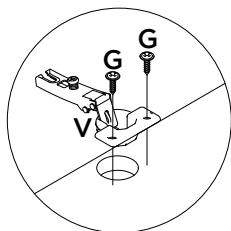
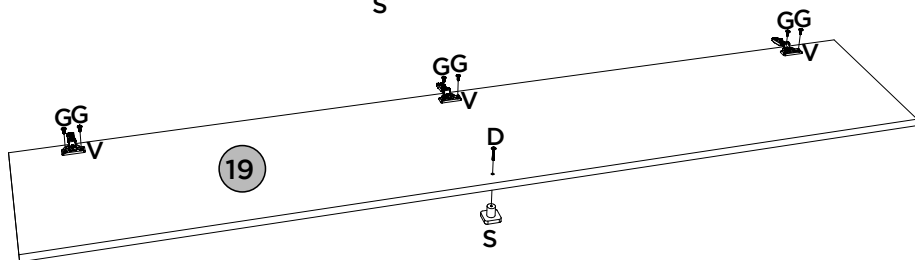
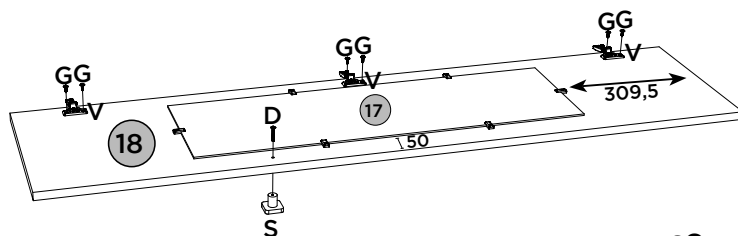
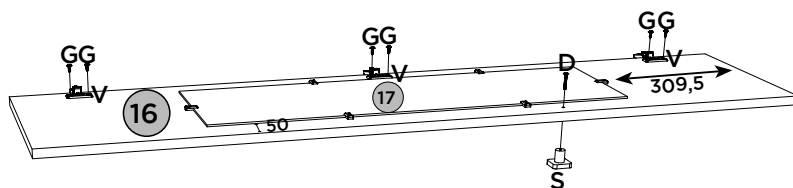
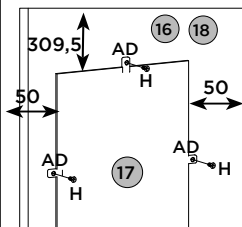
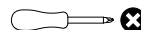

Vídeo: Instalar e regular Dobradiças





Vídeo: Instale y ajuste las bisagras

Vídeo: Install and adjust hinges

PEÇAS REQUERIDAS

16	PORTA ESQUERDA	x1
18	PORTA DIREITA	x1
19	PORTA MAIOR	x2
20	MOLDURA LATERAL	x2
21	MOLDURA FRONTAL	x1

ACESSÓRIOS REQUERIDOS

AG		08
E		02
P		02
U		02
X		01

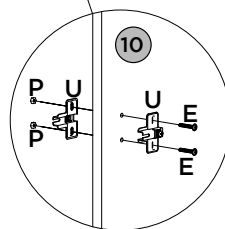
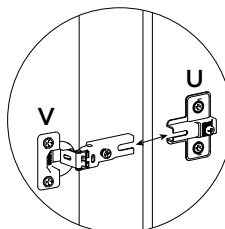
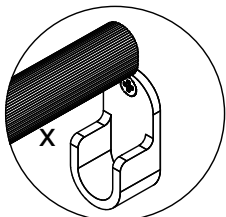
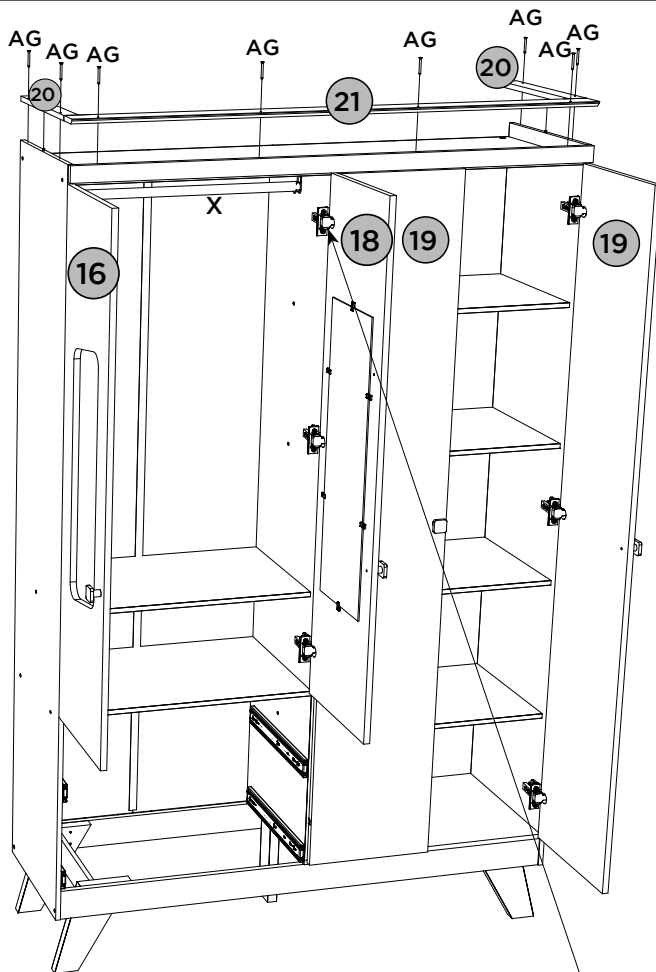
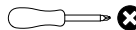
FERRAMENTAS NECESSÁRIAS





PASSO 13

ITM/I125-

PEÇAS REQUERIDAS

23	LADO DE GAVETA	x4
25	FRENTE DE GAVETA	x2

ACESSÓRIOS REQUERIDOS

D		04
M		16
S		04
Z		

FERRAMENTAS NECESSÁRIAS

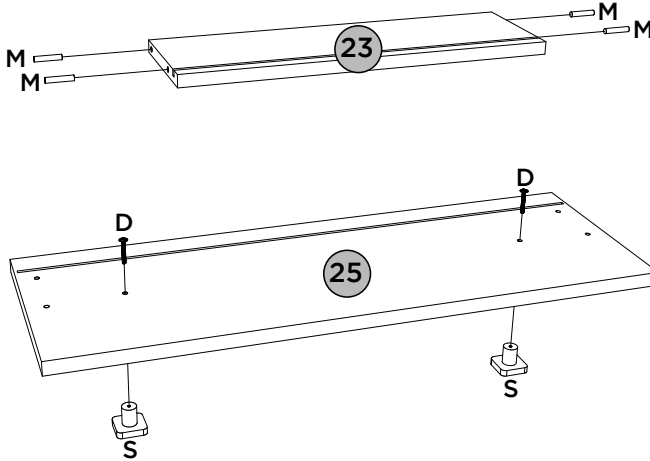
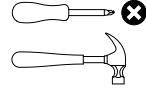

PASSO 14

PEÇAS REQUERIDAS

22	RIPA DE TRÁS	x2
23	LADO DE GAVETA	x4

ACESSÓRIOS REQUERIDOS

Z		
---	---	--

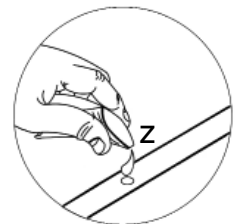
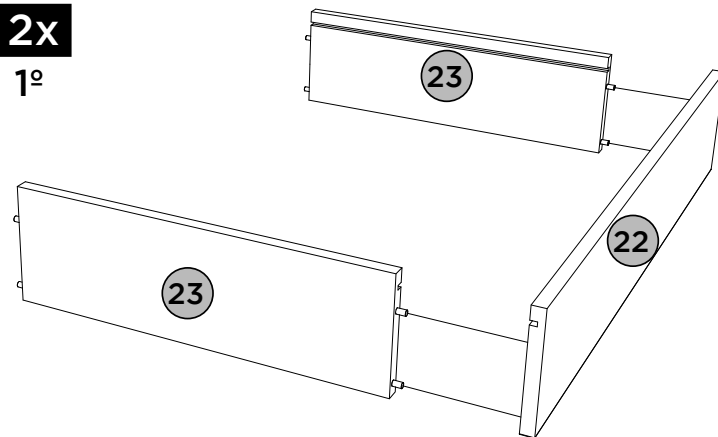



2x
1º

PEÇAS REQUERIDAS

24	FUNDO DE GAVETA	x2
25	FRENTE DE GAVETA	x2

ACESSÓRIOS REQUERIDOS

I		04
Z		

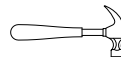
FERRAMENTAS NECESSÁRIAS

2x

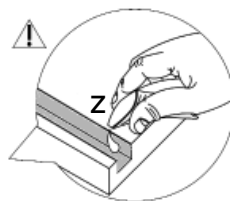
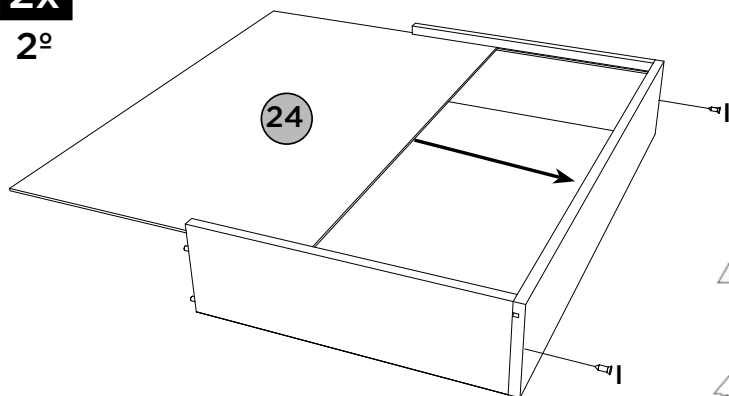



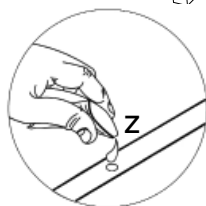
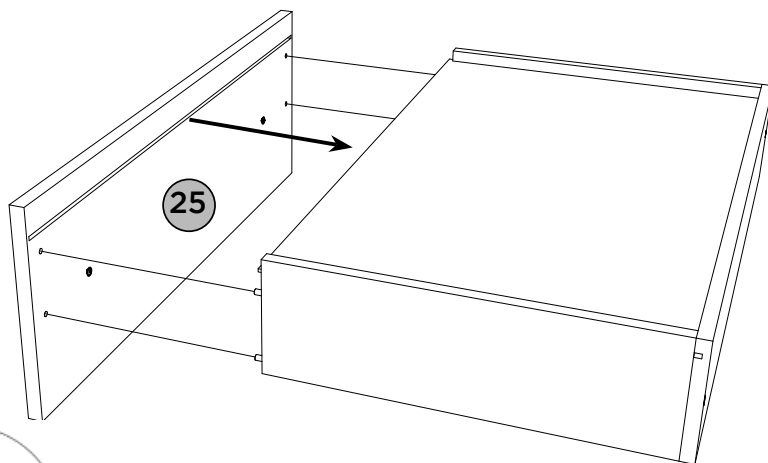

2º

2x

3º



ACESSÓRIOS REQUERIDOS

F			04
H			20
N			04
O			04
W			02

FERRAMENTAS NECESSÁRIAS

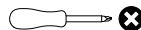

2x

4º

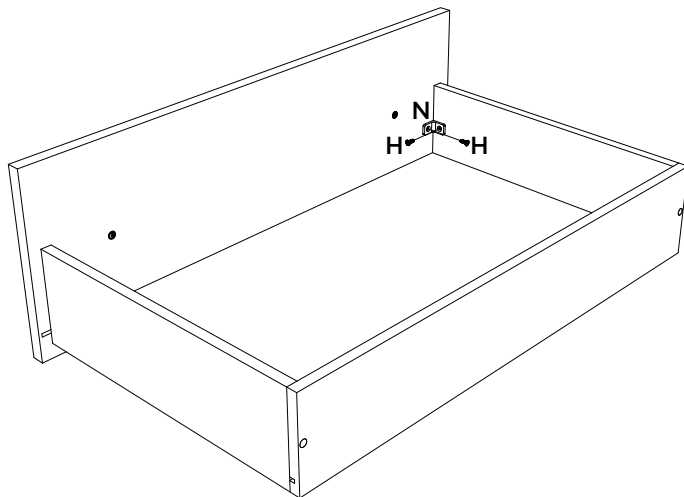

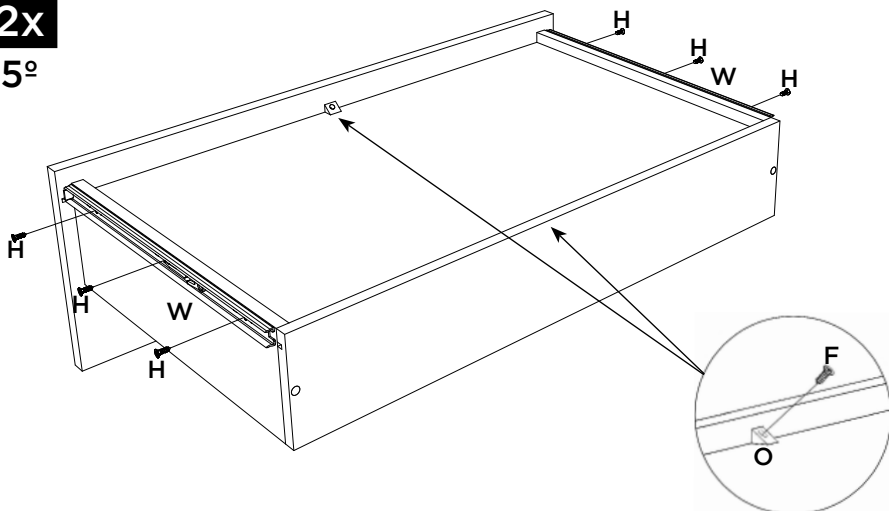

2x

5º



ACESSÓRIOS REQUERIDOS

AA		26
AB		03
AC		01

Pesos máximos recomendados com carga distribuída
Peso máximo recomendado con la carga distribuida
Recommended maximum weight with distributed load.

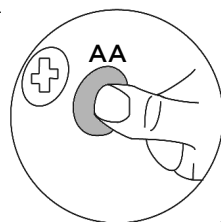
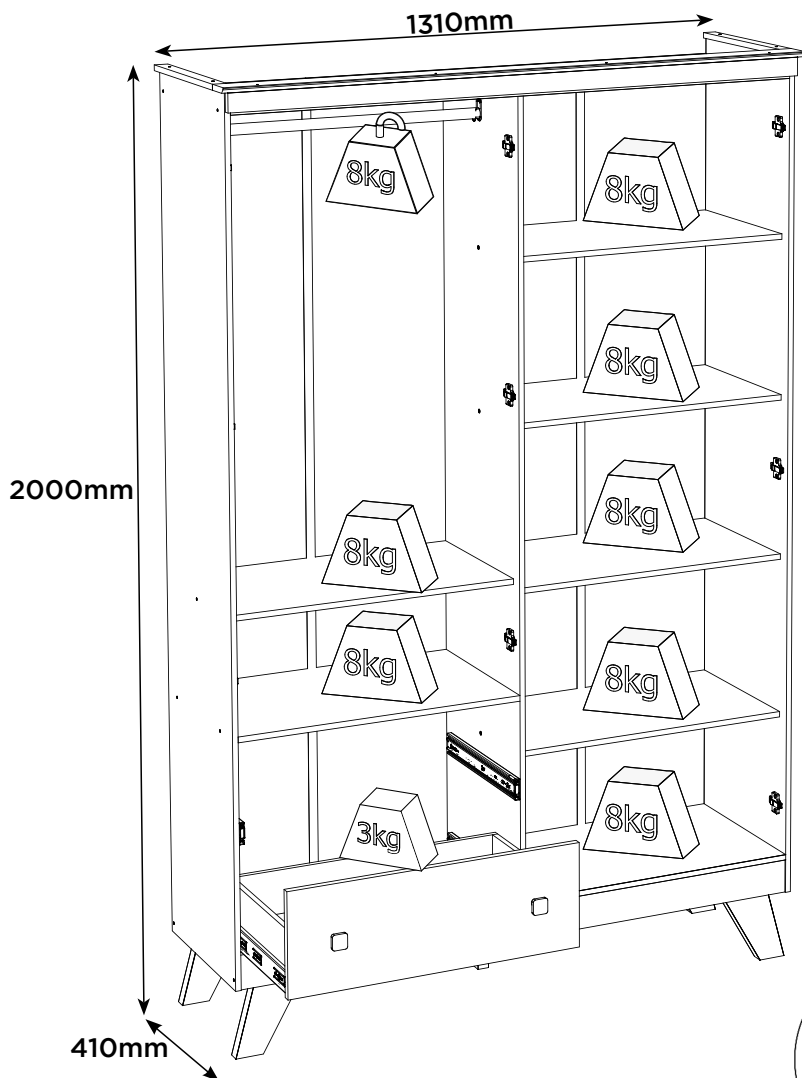

Produto Concluído
Producto terminado
Finished Product

