

8 Passo
Paso
Step

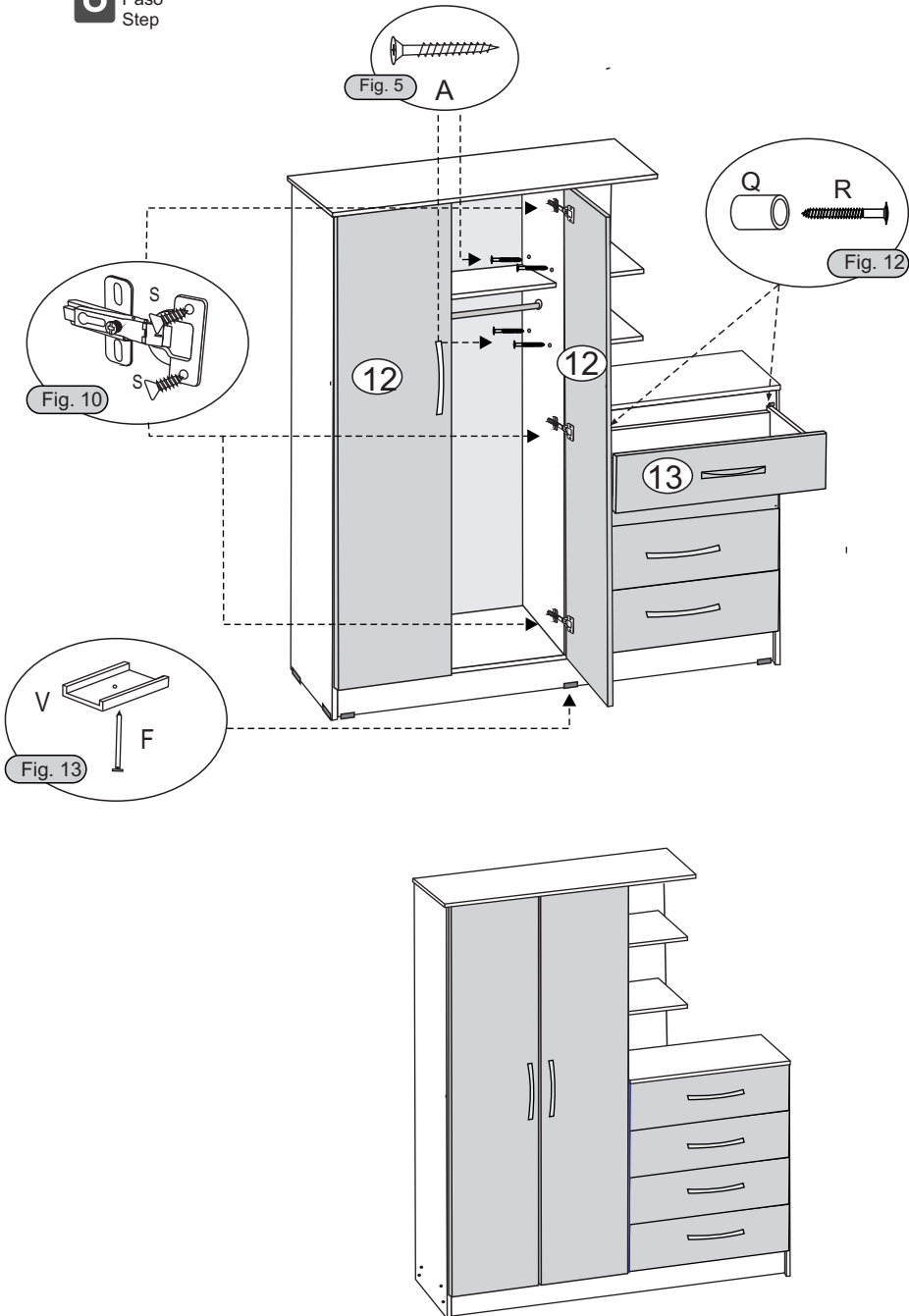

MANUAL DE MONTAGEM
INSTRUCCIONES DE ARMADO
ASSEMBLY INSTRUCTIONS

Comoda PNR

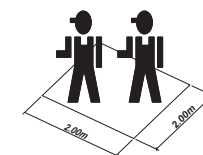
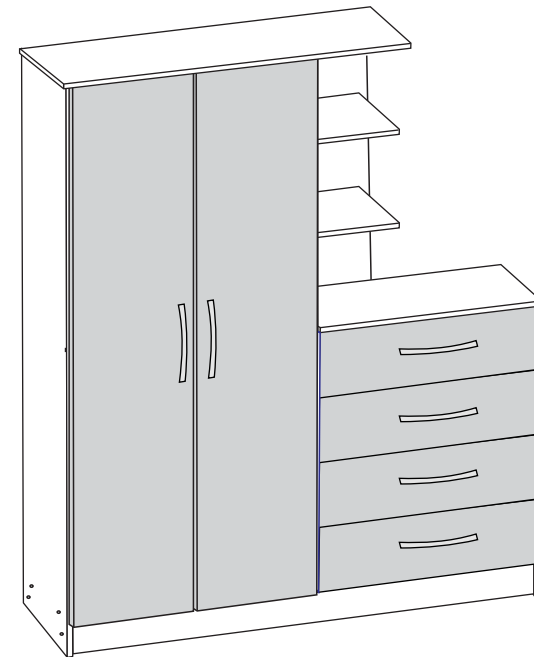











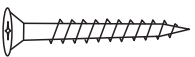







FERRAMENTAS NECESSÁRIAS
HERRAMIENTAS NECESARIAS
TOOLS NECESSARY

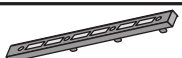
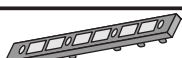

60 min



FERRAGENS/ HERRAJE/ HARDWARE

A	Parafuso 3,5 x 35 c/chata Tornillo Screw		16
B	Parafuso 3,5 x 25 c/flangeada Tornillo Screw		12
C	Cantoneira 18x18 Esquinera Cantoneira		11
D	Cavilha 6 x 30 Clavija Wood Peg		24
E	Prego Anelado 10 x 10 Clavo 10 x 10 Nail 10 x 10		16
F	Prego 10 x 10 Clavo 10 x 10 Nail 10 x 10		96
H	Sapata L 40 mm Tirador Handle		2
J	Cola Pegamento Glue		1
L	Puxador 96 mm Tirador Handle		6
M	Dobradiça c/calço 		4
N	Corrediça plástica Rieles Slides		1
P	Corrediça plástica Rieles Slides		7
Q	Rolete Pino Rolete		2
R	Parafuso 3,5 x 20 c/flangeada Tornillo Screw		2
S	Parafuso 3,5 x 12 c/Chata Tornillo Screw		38
U	Porca cilíndrica Tuerca cilíndrica Cylindrical nut		4
V	Sapata 'U' Zapata 'U' Shoes		2
X	Pino Suporte prateleira Soporte Support		4
Y	Suporte Cabideiro Soporte Support		2

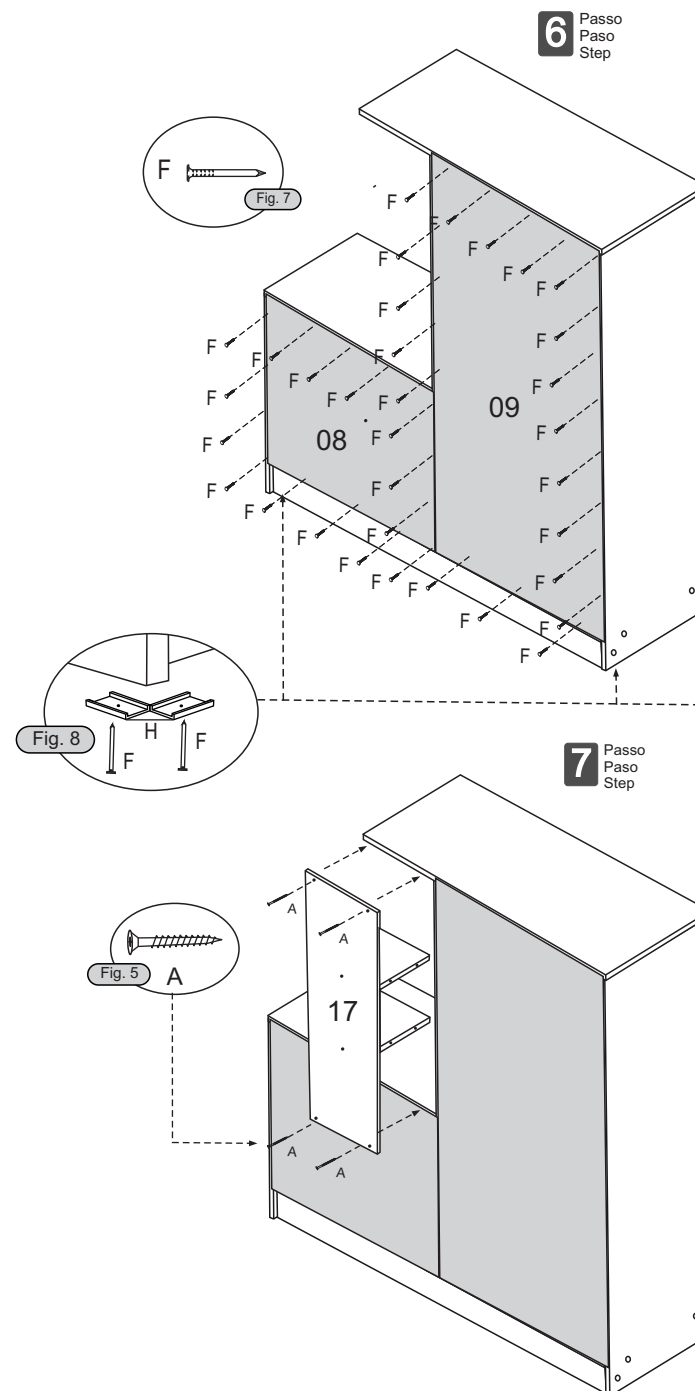

MONTAGEM GAVETA

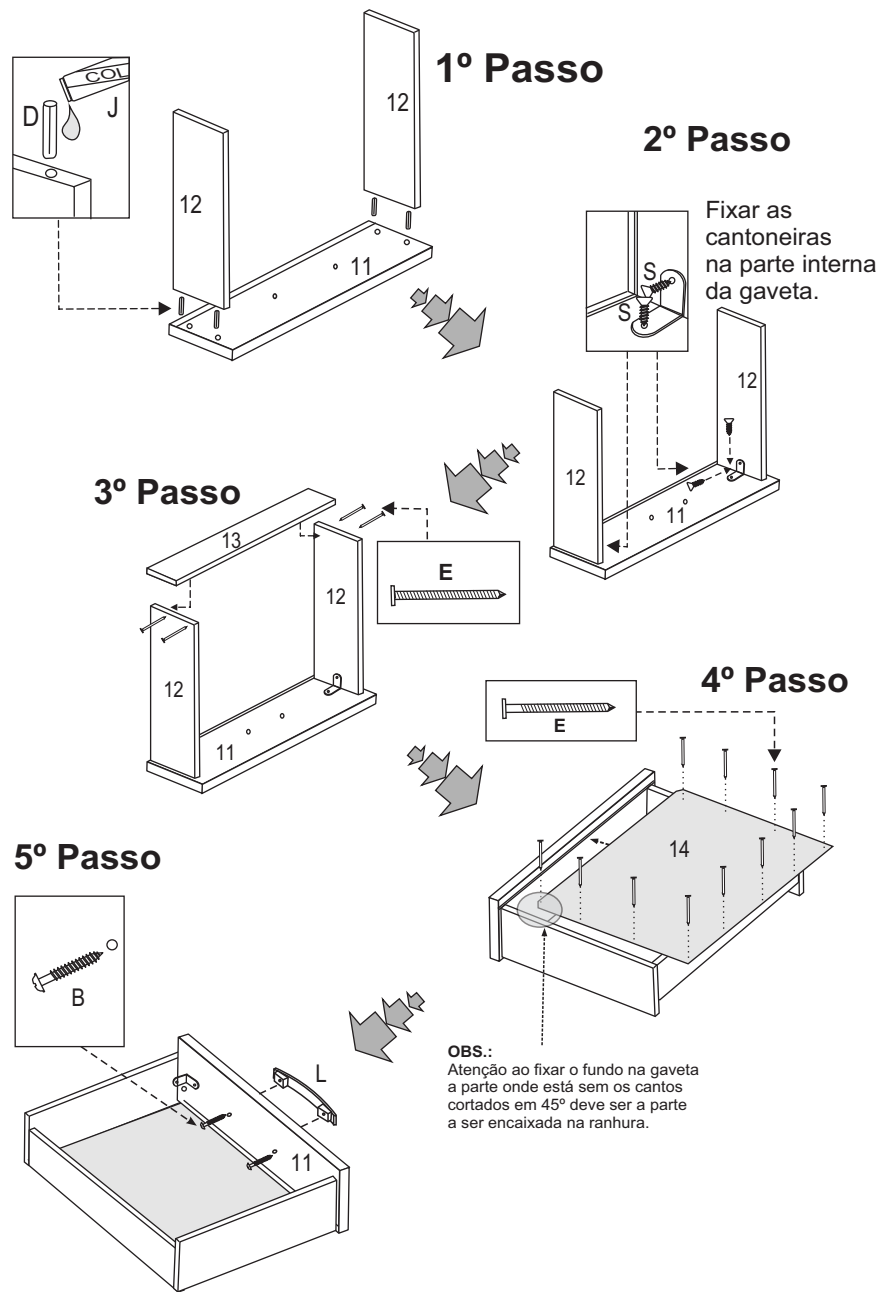

Relação de Peças em mm

Nº	PEÇA	MEDIDA
01	Base	630 x 385
02	Lateral Esquerda	1453 x 385
03	Divisão	1330 x 385
04	Rodapé (2 pç)	1200 x 110
05	Chapéu superior	940 x 405
06	Lateral Cômoda	770 x 385
07	Tampo Cômoda	610 x 405
08	Costa Pequena	680 x 608
09	Costa Grande	1350 x 300
10	Portas (2 pç)	1335 x 300
11	Frente Gaveta (4 pç)	605 x 160
12	Lateral gaveta (8 pç)	350 x 80
13	Trazeiro gaveta (4pç)	503 x 80
14	Fundo gaveta (4pç)	588 x 350
15	Prateleira	592 x 300
16	Prateleira externa (2pç)	240 x 290
17	Costa Prateleiras	690 x 260
18	Pau de Cabide	580

