

Roupeiro 03 Portas Deslizantes 02 gavetas |

Ropero 03 Puertas Deslizantes 02 cajones | Wardrobe 03 Sliding Doors 02 Drawers

- B352-127 Nature/Off White.
- B352-130 Castanho HP.

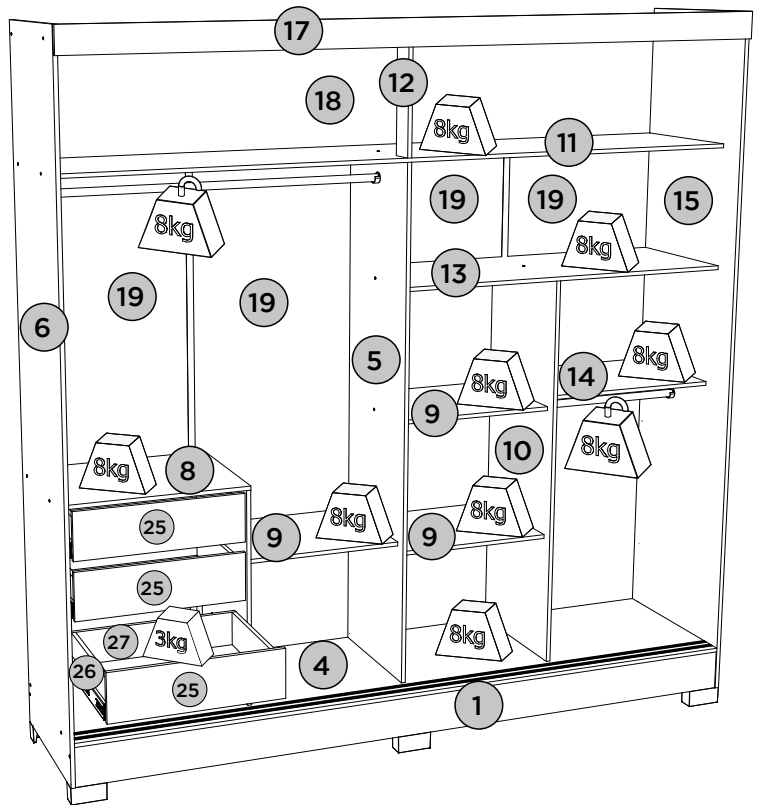

Pesos máximos recomendados com carga distribuída
Peso máximo recomendado con la carga distribuida
Recommended maximum weights with evenly distributed.

Requisitos para montagem
Requisitos para la montaje
Assembly Requirements

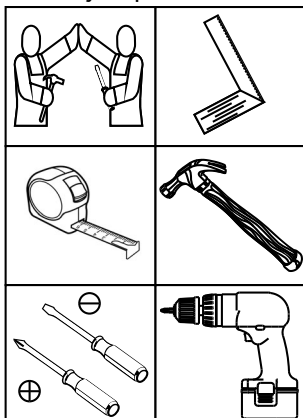

Imagens meramente ilustrativas,
não acompanha o produto.
Imágenes ilustrativas, no incluidas
con el producto.
Illustrative images, not included
with the product.

AVISO

Para limpeza de seu móvel, use uma flanela seca ou umedecida, e não utilize produtos químicos que possam danificar seu produto.

SISTEMA DE MONTAGEM

O sistema de montagem dos produtos, funciona de acordo com a ordem crescente dos números indicados no desenho. Ex: 01, 02, 03, 04... até a conclusão da montagem.

ASSISTÊNCIA TÉCNICA

Para solicitação de Assistência Técnica você consumidor deverá entrar em contato com o Lojista o qual você realizou a compra deste produto e solicitar a assistência técnica das peças avariadas. A garantia abrange todas as peças, partes e componentes que eventualmente venham apresentar defeito de fabricação no prazo de 03 (três) meses, contando a partir da entrega do produto ao consumidor, mediante nota fiscal de compra. Se houver qualquer alteração na estrutura do produto ou ocorrer defeito por negligência do montador/consumidor em relação a instrução de montagem e manuseio, não será fornecido assistência técnica gratuita.

ADVERTENCIA

Para limpieza de su móvil, use una flanela seca o húmeda, y no utilice productos químicos que puedan dañar su producto.

SISTEMA DE MONTAJE

El sistema de montaje de los productos funciona de acuerdo con el orden creciente de los números indicados en el dibujo. Ej.: 01, 02, 03, 04... hasta la conclusión del montaje.

ASISTENCIA TÉCNICA

Para solicitar Asistencia Técnica, el consumidor debe comunicarse con el Comercio que usted realizó la compra de este producto y solicita asistencia técnica para las partes dañadas. La garantía cubre todas las partes, piezas y componentes que eventualmente puedan presentar defecto de fabricación en el plazo de 03 (tres) meses, contando a partir de la entrega del producto al consumidor, mediante factura de compra. Si se produce algún cambio en la estructura del producto o se produce un defecto por negligencia del montador/consumidor en relación con las instrucciones de montaje y manipulación, no se prestará asistencia técnica gratuita.

NOTICE

To clean your furniture, use a dry or wet cloth, and do not use chemicals that may damage your product.

ASSEMBLY SYSTEM

The products' assembly system works according to the increasing order of the indicated numbers. For example: 01, 02, 03, 04 ... to the end of the assembly.

TECHNICAL ASSISTANCE

To request Technical Assistance, the consumer must contact the retailer from whom you purchased this product and request technical assistance for the damaged parts. The warranty covers all parts, parts and components that may eventually present a manufacturing defect within a period of 03 (three) months, counting from the delivery of the product to the consumer, by means of a purchase invoice. If there is any change in the structure of the product or defect occurs due to negligence of the assembler/consumer in relation to the assembly and handling instruction, free technical assistance will not be provided.

1

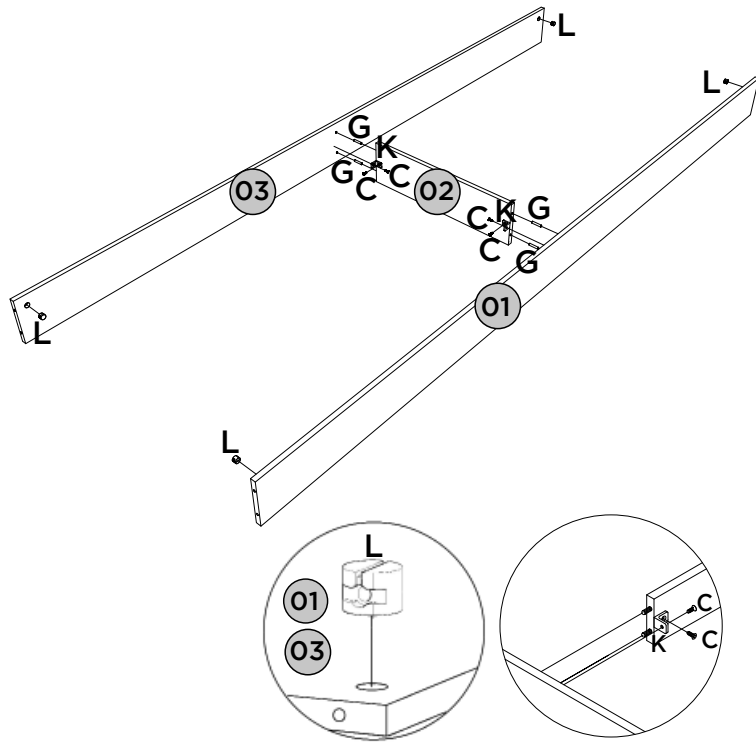

2

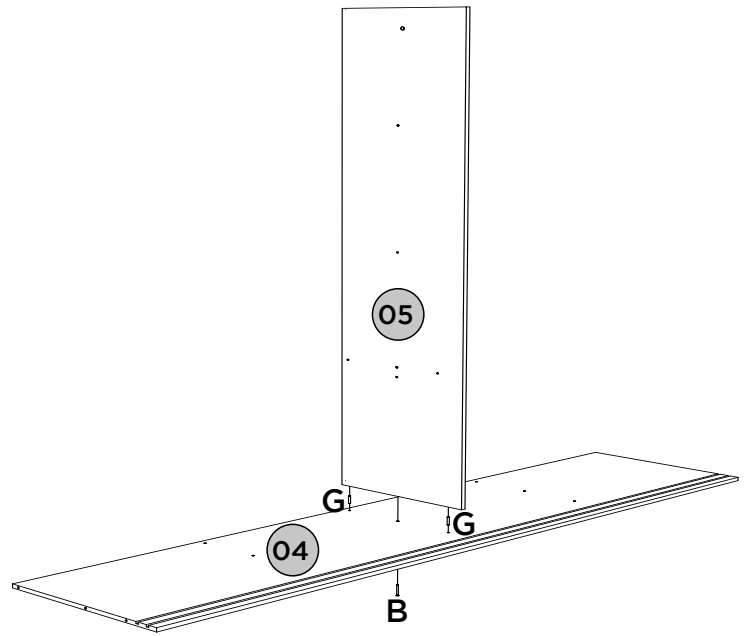

3

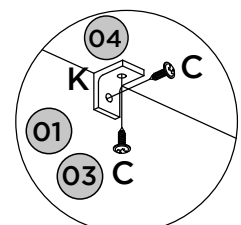
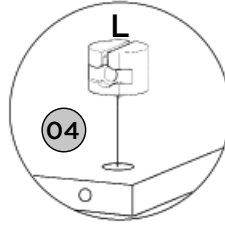
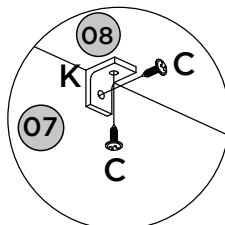
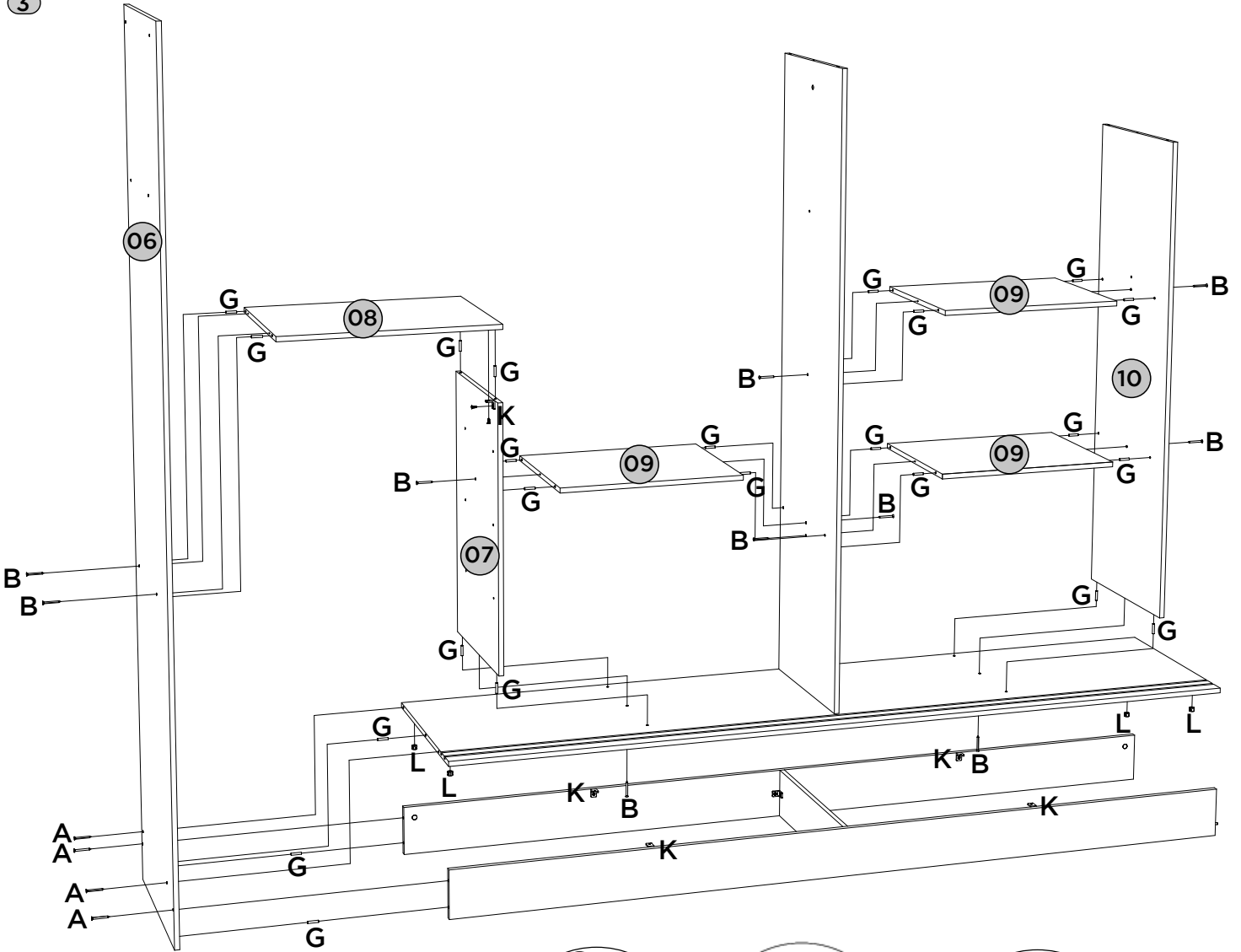

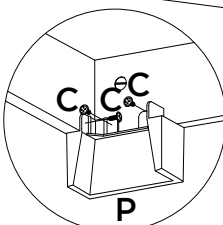
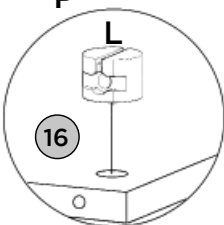
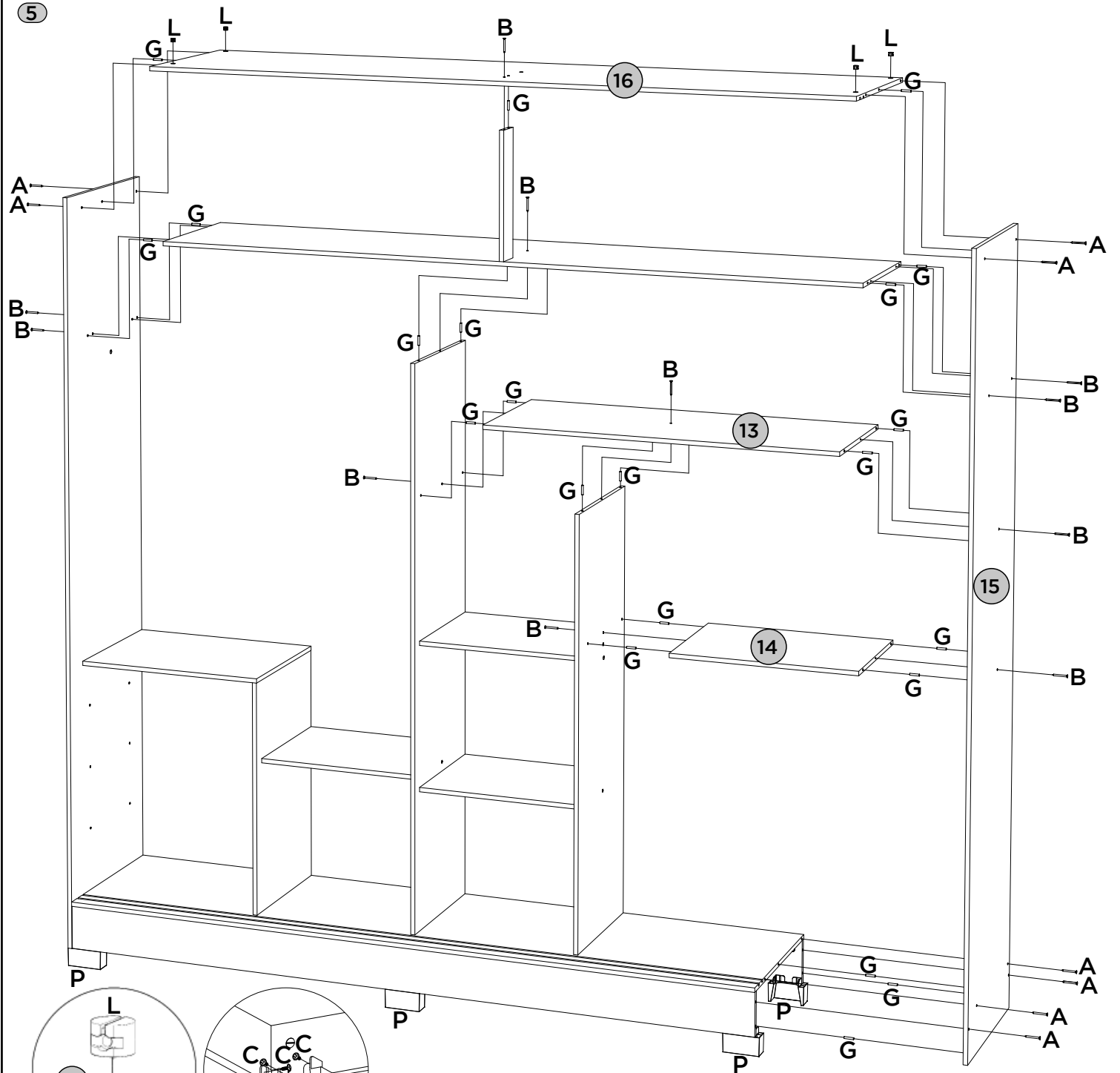
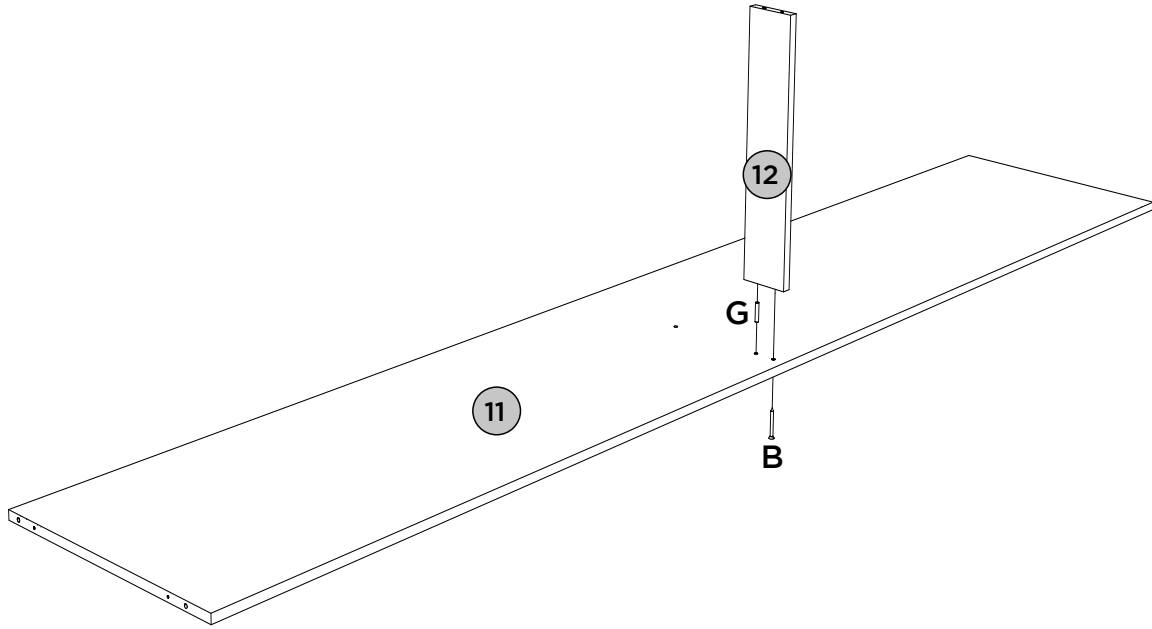

6

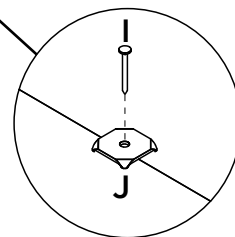
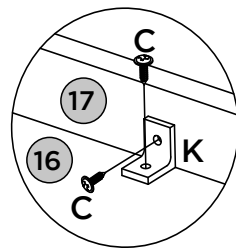
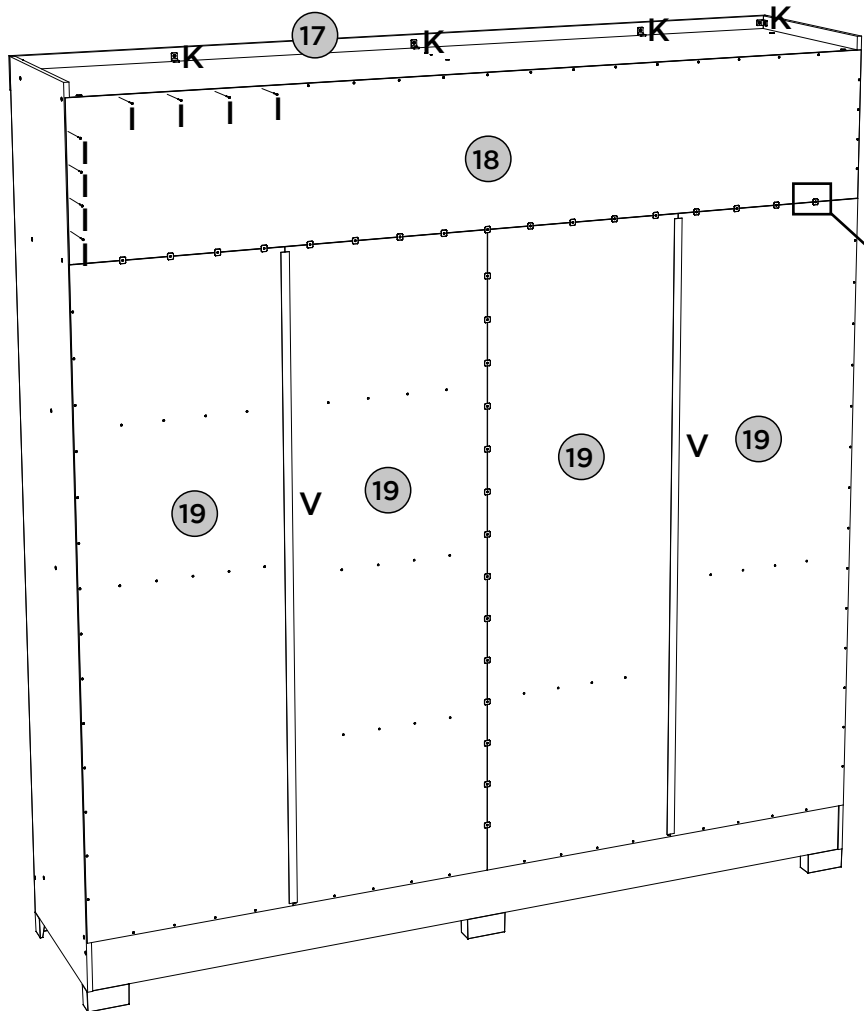

- Fixar os pregos a uma distância de 120mm de um para outro.
- Fijar las uñas a un distancia de 120 mm uno a otro.
- Fix the nails at a distance of 120mm from one to the other

7

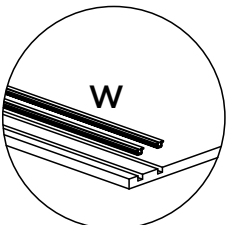
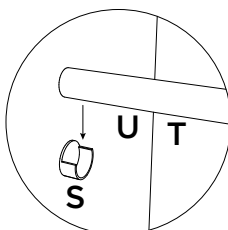
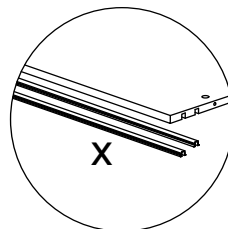
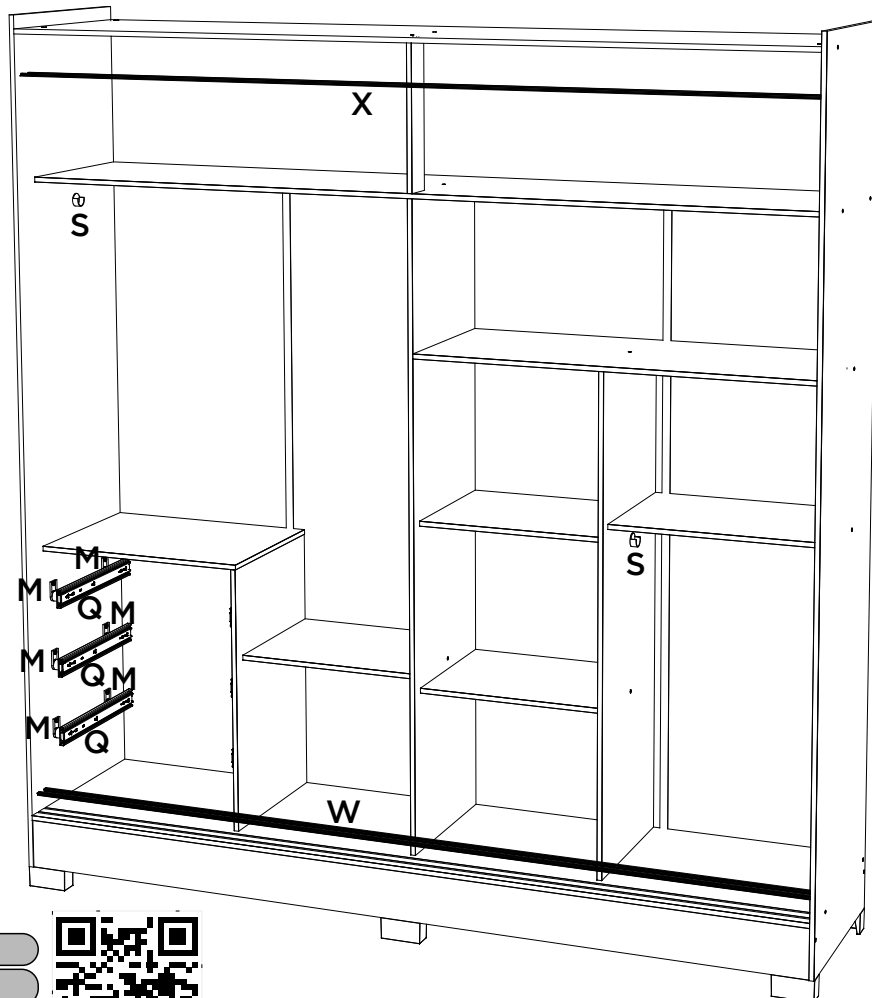
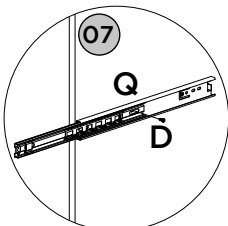
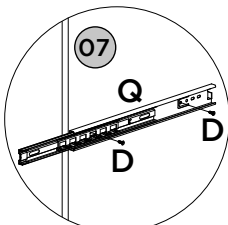
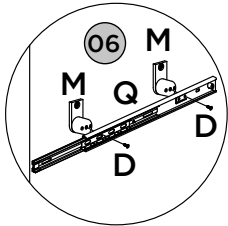
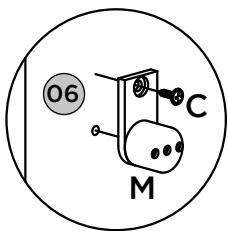

- Video: Dicas para instalar corredeira
- Video: consejos para instalar la diapositiva
- Video: Tips for installing slide



8

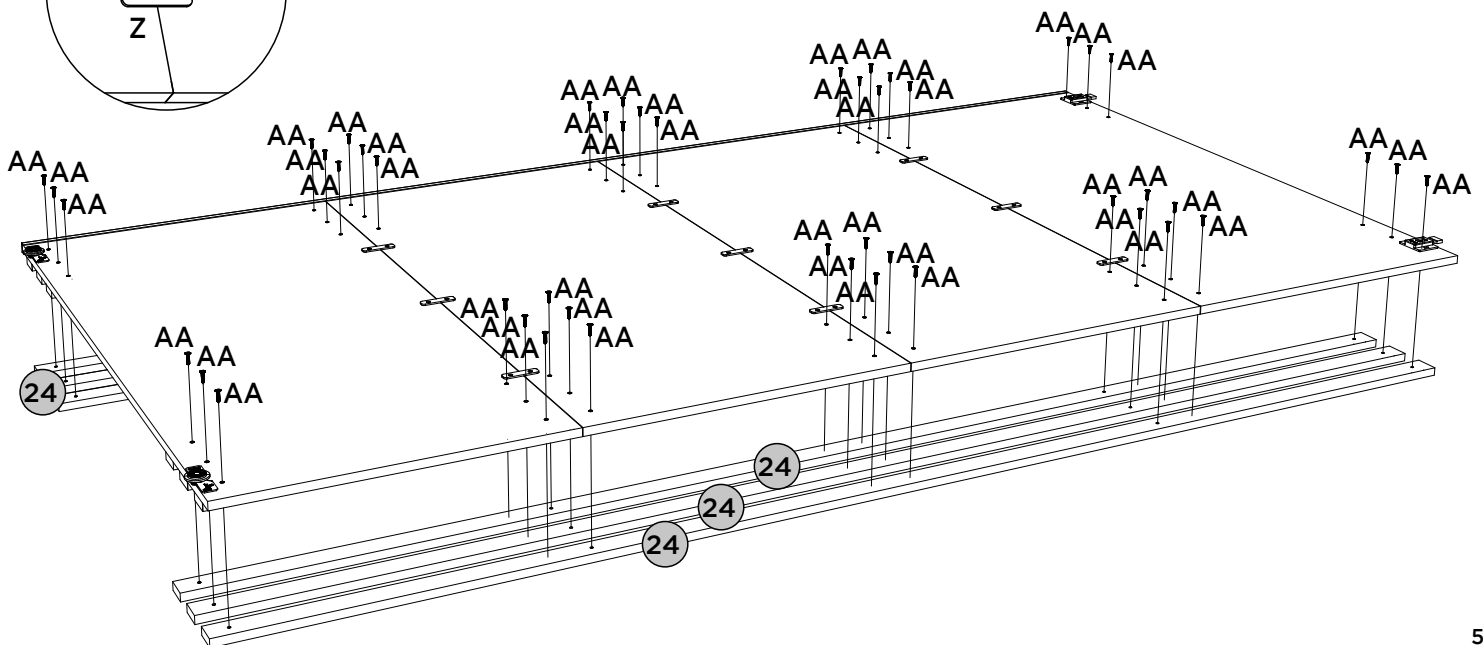
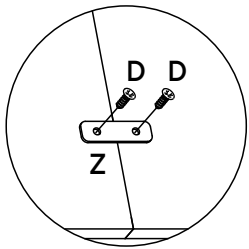
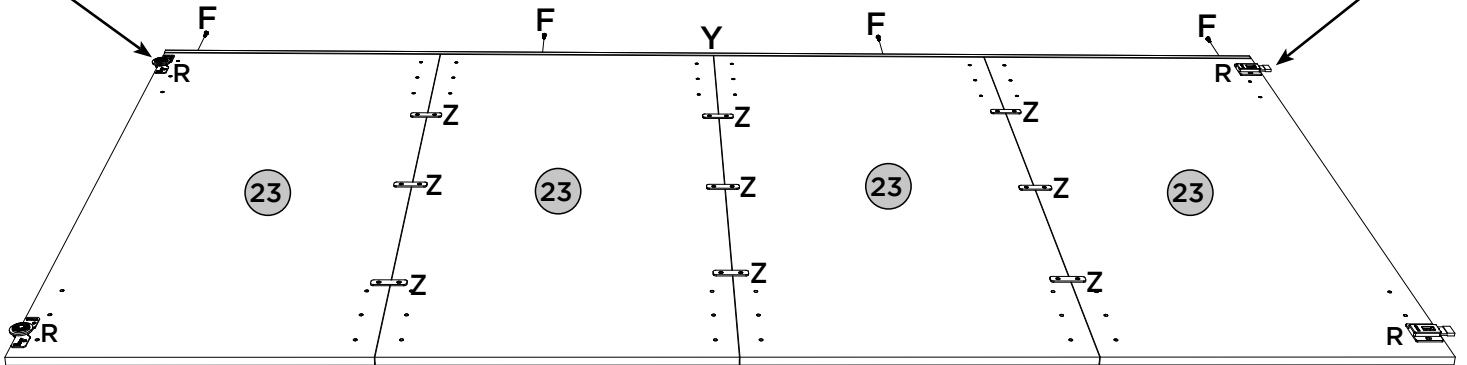
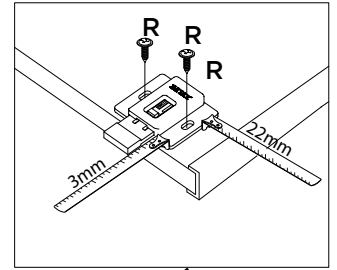
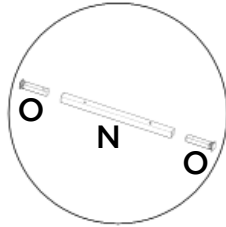
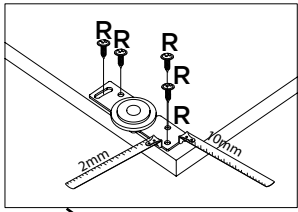
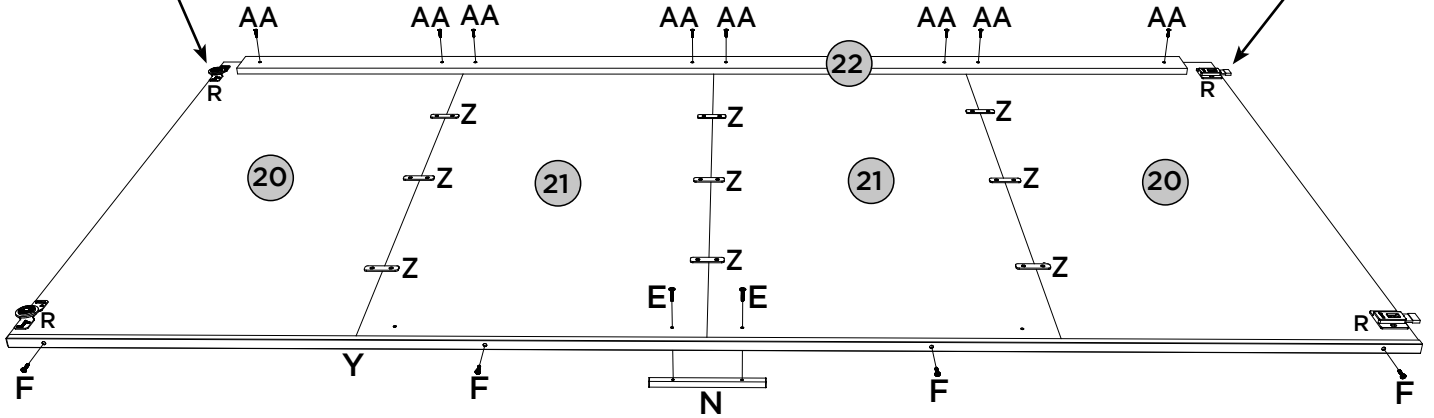
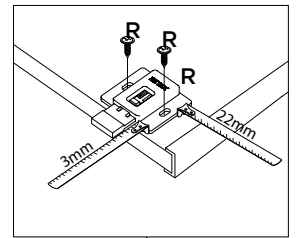
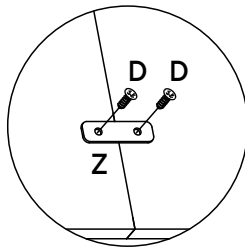
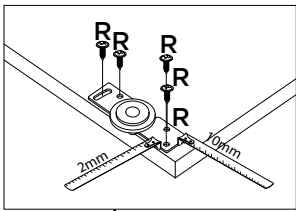

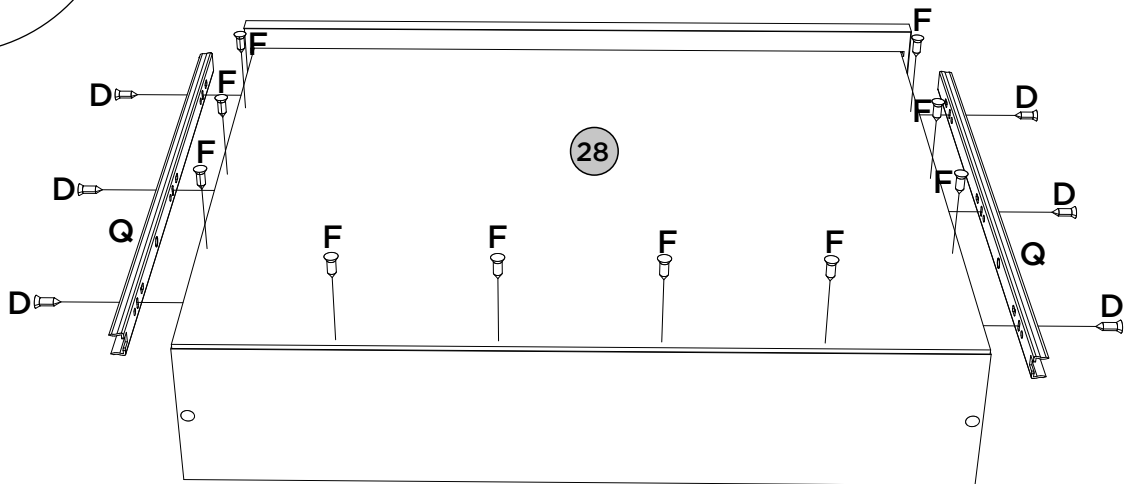
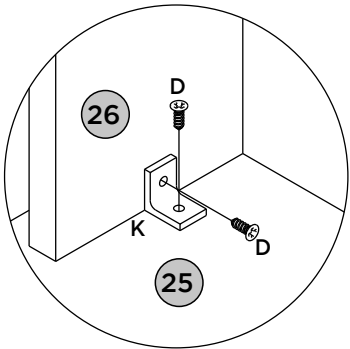
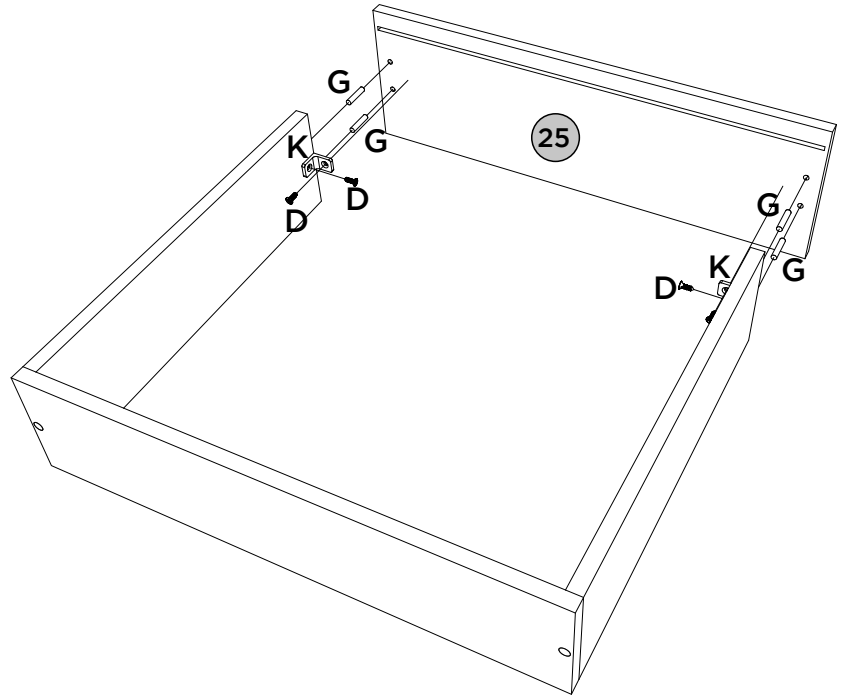
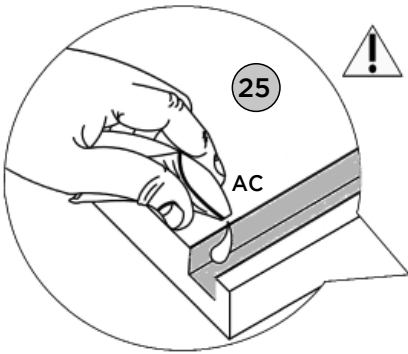
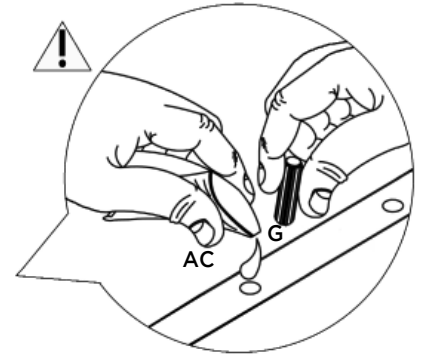
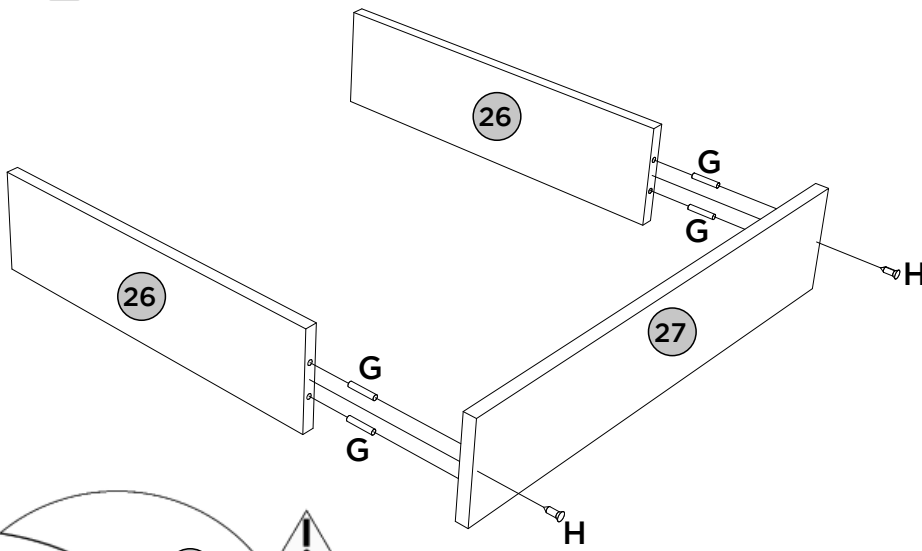

Fixar as corredeiras nessas furações
 Fijar las dapositivas de estos agujeros
 Fix the slides in these holes

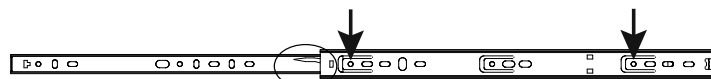

Para a desmontagem da corredeira, siga a instrução ao lado



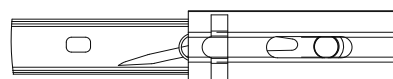
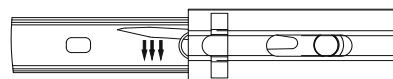

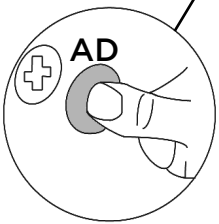













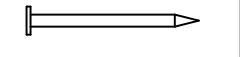







Para el desmontaje de la diapositiva, siga las instrucciones en el lado
 For disassembly of the slide, follow the instruction on the side



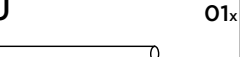

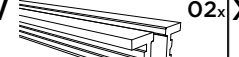
Item	Caixa Caja Box	Qtd Ctd Qty	Descrição Descripción Description	Medidas (mm) Dimensions (mm) Size (measurements) (mm)
01	2/3	01	Rodapé frontal Rodapié frontal Front footboards	1970x120x12
02	1/3	01	Travessa do rodapé Carril pie Footboard tray	435x120x12
03	2/3	01	Rodapé traseiro Rodapié trasero Rear footboard	1970x120x12
04	1/3	01	Base Base Base	1970x465x12
05	2/3	01	Divisão División Division	1561x385x12
06	2/3	01	Lateral esquerda Lateral izquierda Left side	2100x465x12
07	1/3	01	Divisão das Gavetas División de Cajones Drawer Division	648x385x12
08	1/3	01	Tampo das gavetas Tapa de los cajones Drawers top	527x385x12
09	1/3	03	Prateleira Estante Shelf	453x350x12
10	1/3	01	Divisão Menor División menor Minor Division	1189x383x12
11	2/3	01	Chão Do Maleiro Piso del maletero Trunk Floor	1970x385x12
12	1/3	01	Ripa do Maleiro Listón Maleiro Maleiro Slat	350x73x12
13	1/3	01	Prateleira Maior Estante mas Grande bigger shelf	979x385x12
14	1/3	01	Prateleira do Calceiro Estante de Calceiro Calceiro's Shelf	514x350x12
15	2/3	01	Lateral direita Lateral derecha Right side	2100x465x12
16	1/3	01	Tampo Superior Tapa Más Alto Top high	1970x465x12
17	2/3	01	Chapéu Sombrero Hat	1992x80x12
18	2/3	01	Fundo Superior Fondo Más Alto High Bottom	1990x367x3
19	1/3	04	Fundo Fondo Bottom	1578x497x3
20	3/3	02	Painel Inferior Superior Panel inferior superior Upper Lower Panel	997x477x12
21	3/3	02	Painel Central Panel Central Center Panel	997x477x12
22	2/3	01	Travessa Da Porta Travesaño de la puerta Door Traverse	1800x60x12
23	3/3	04	Painel Panel Panel	997x477x12
24	2/3	06	Aplicação Aplica Apply	1906x35x12
25	1/3	03	Frente de gaveta Frente del cajón Drawer front	481x145x12
26	1/3	06	Lado de gaveta Lado del cajón Drawer side	350x100x12
27	1/3	03	Ripa de trás Listón trasero Rear batten	469x100x12
28	3/3	03	Fundo de gaveta recortado Fondo de cajón recortado Drawer bottom trimmed	468x367x3

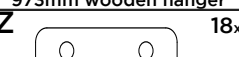
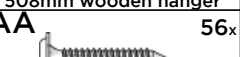
Ferragens | Herrajes | Hardware

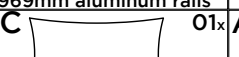
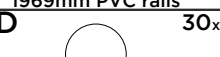
A  Parafuso 4,5x50mm CHT. Tornillo 4,5x50mm CHT. Screw 4,5x50mm CHT.	12x	B  Parafuso 3,5x40mm CHT. Tornillo 3,5x40mm CHT. Screw 3,5x40mm CHT.	23x	C  Parafuso 3,5x12mm FLA. Tornillo 3,5x12mm FLA. Screw 3,5x12mm FLA.	48x	D  Parafuso 3,5x12mm CHT. Tornillo 3,5x12mm CHT. Screw 3,5x12mm CHT.	81x	E  Parafuso 3,5x18mm FLA. Tornillo 3,5x18mm FLA. Screw 3,5x18mm FLA.	02x	F  Parafuso 3,0x16mm CHT. Tornillo 3,0x16mm CHT. Screw 3,0x16mm CHT.	38x
G  Cavilha 5x25mm Cinta 5x25mm Dowel 5x25mm	76x	H  Prego 12x12mm Anelado Clavo 12x12mm Anillado Ringed Nails 12x12mm	06x	I  Prego 10x10mm Clavo 10x10mm Nail 10x10mm	118x	J  Fixador de fundos Fijador de fondos Bottom fixer	26x	K  Cantoneira plástica Cantenera plástica Plastic angle brackets	18x	L  Porca cilíndrica Tuerca cilíndrica Cylindrical nut	12x
M  Distanciador de corredeira Distanciador de deslizamiento Sliding spacer	06x	N  Puxador Alumínio 161,5mm Tirador Aluminio 161,5mm Handle Aluminum 161,5mm	01x	O  Ponteira Oliva Londres Oliva London Puntero Oliva London Pointer	01x KIT	P  Pé "U" 50x40x100mm Pie "U" 50x40x100mm 50x40x100mm "U" feet	06x	Q  Corredeira Telescópica 350 Corredera telescópico 350 Sliding telescopic 350	03x PAR	R  Kit Roldana JM300 (2Portas) Kit Roldán JM300 (2Puertas) JM300 Pulley Kit (2Doors)	01x KIT
S  Suporte cabideiro Soporte de percha Coat hanger support	04x	T  Cabideiro Madeira 973mm Cabezal Madera 973mm 973mm wooden hanger	01x	U  Cabideiro Madeira 508mm Cabezal Madera 508mm 508mm wooden hanger	01x	V  Perfil "I" 1559mm Perfil "I" 1559mm Profile "I" 1559mm	02x	W  Trilho Alumínio 1969mm Riel Aluminio 1969mm 1969mm aluminum rails	02x	X  Trilho PVC 1969mm Carril PVC 1969mm 1969mm PVC rails	02x
Y  Perfil Antiempeno "U" Perfil Antialabeo "U" Profile Antiwarping "U"	02x	Z  Suporte de Metal Soporte Metalico Metal Support	18x	AA  Parafuso 3,0x20 CHT. Tornillo 3,0x20 CHT. Screw 3,0x20 CHT.	56x	AB  Etiqueta resinada Briz Etiqueta resinada Briz Briz resin label	01x	AC  Sachê de cola Bolsa de pegamento Glue bag	01x	AD  Adesivo tapa parafuso 10mm Adhesivo tapón de tornillo 10mm Bolt cover adhesive 10mm	30x