

**Roupeiro 04 Portas e 02 Gavetas | Armario 04 puertas y 02 cajones |  
Wardrobe 04 Doors 02 Drawers**

- BE12-10 Branco
- BE12-46 Preto Tex/Branco
- BE12-74 Gris/Palha
- BE12-76 Gris
- BE12-86 Branco Fosco
- BE12-87 Chocolate Fosco
- BE12-94 Rústico
- BE12-101 Café
- BE12- 138 Castanho HP/OFF White

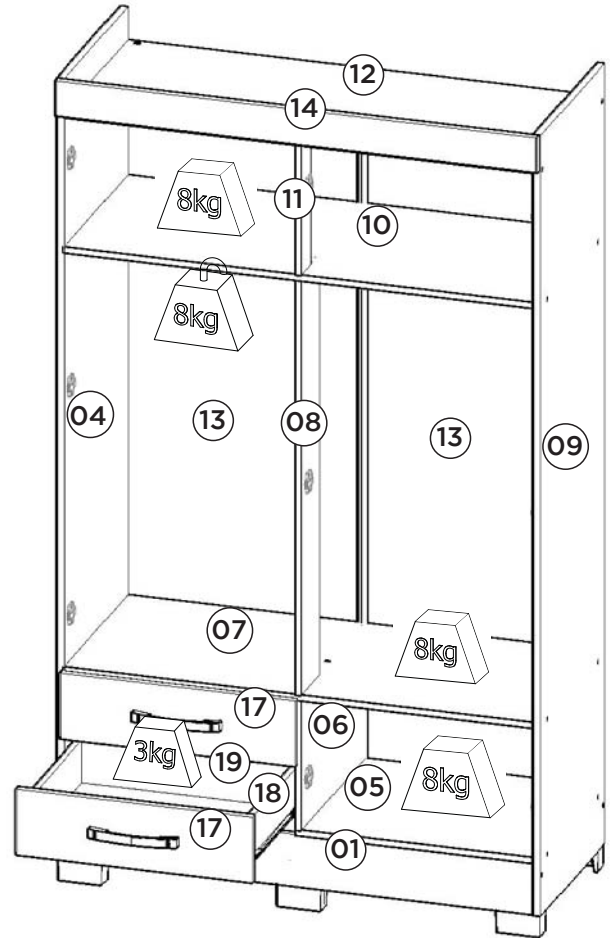

**Requisitos para montagem  
Requisitor para la montaje  
Assembly Requirements**

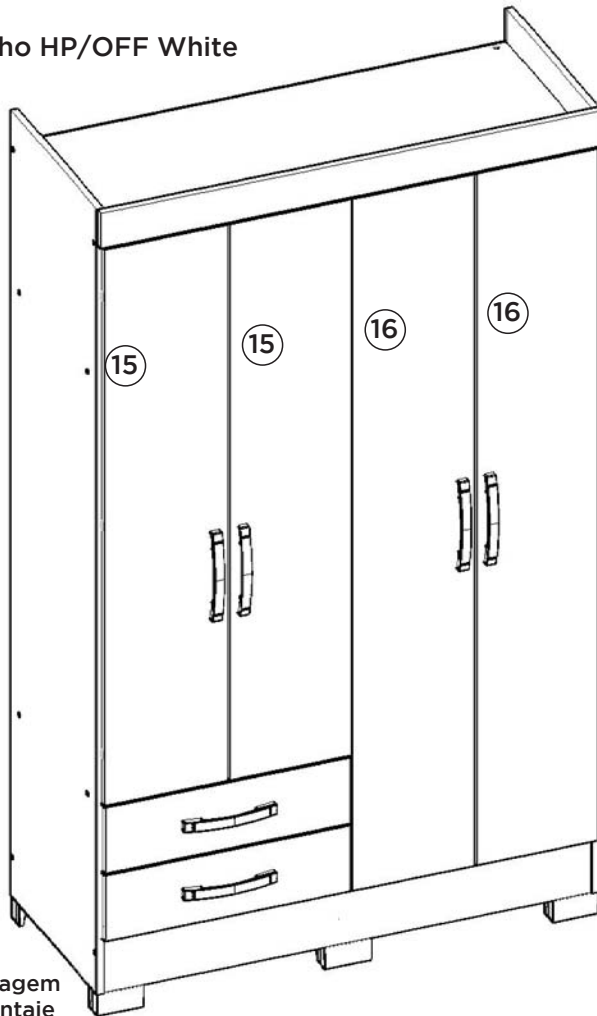
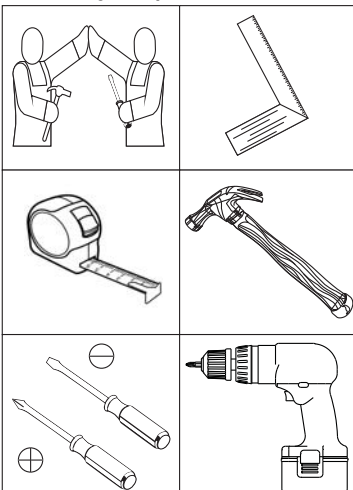

Imagens meramente ilustrativas  
Imágenes meramente ilustrativas  
Images for illustration only

**Pesos máximos recomendados com carga distribuída  
Peso máximo recomendado con la carga distribuida  
Recommended maximum weights with evenly distributed.**

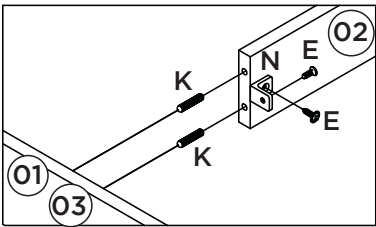
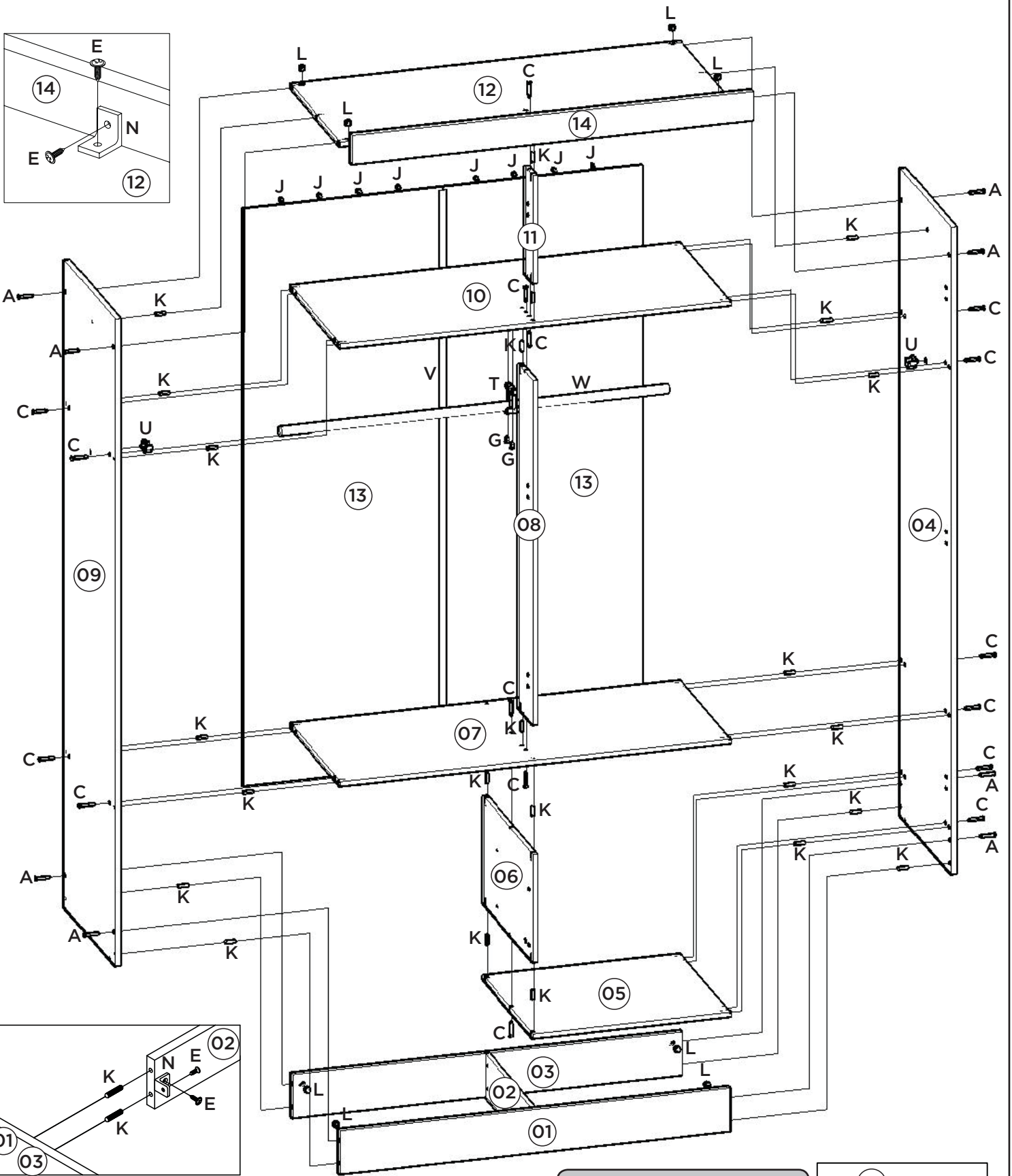
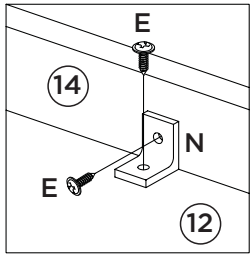

Fixação da cantoneira (N) nos rodapés (01) e (03).

Soporte de fijación (N) los pies (01) y (03).

Angle bracket (N) fixing on footboards (01) and (03).

Fixação da cantoneira (N) na base (05) com os rodapés (01) e (03).

Soporte de fijación (N) la base (05) con los pies (01) y (03).

Angle bracket (N) fixing on the base (05) with the footboards (01) and (03).

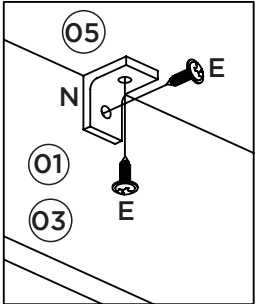

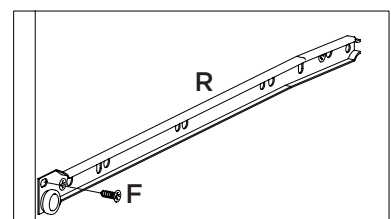
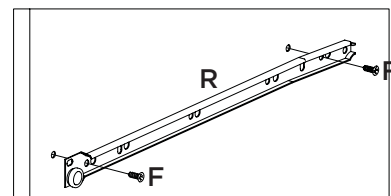
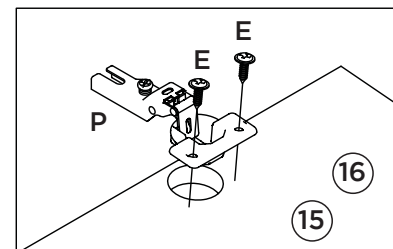
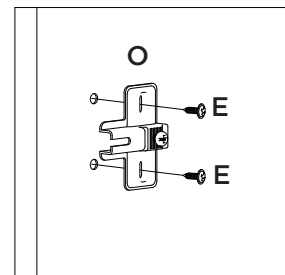
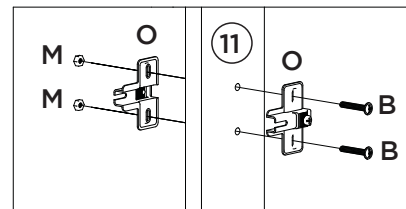
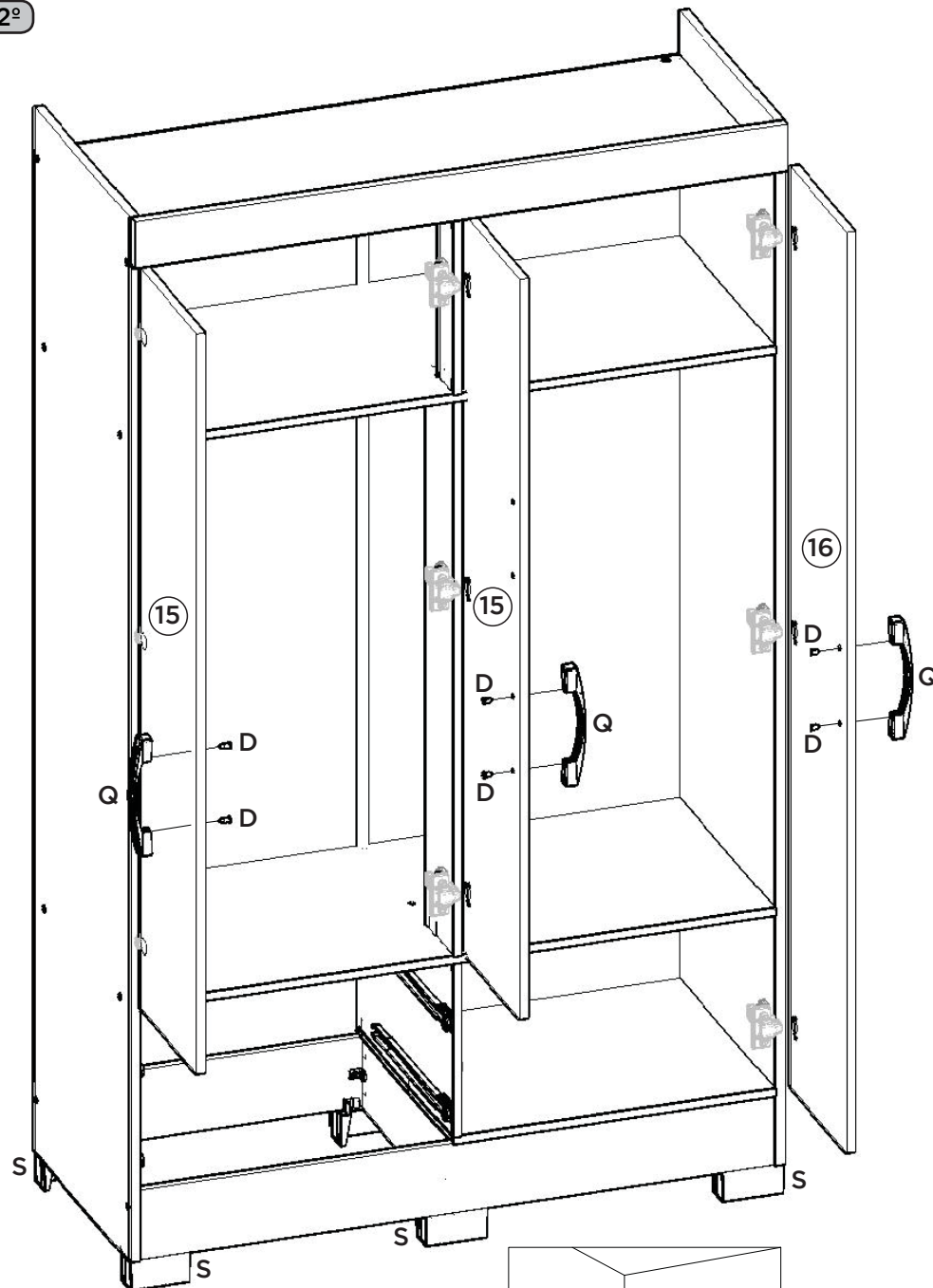



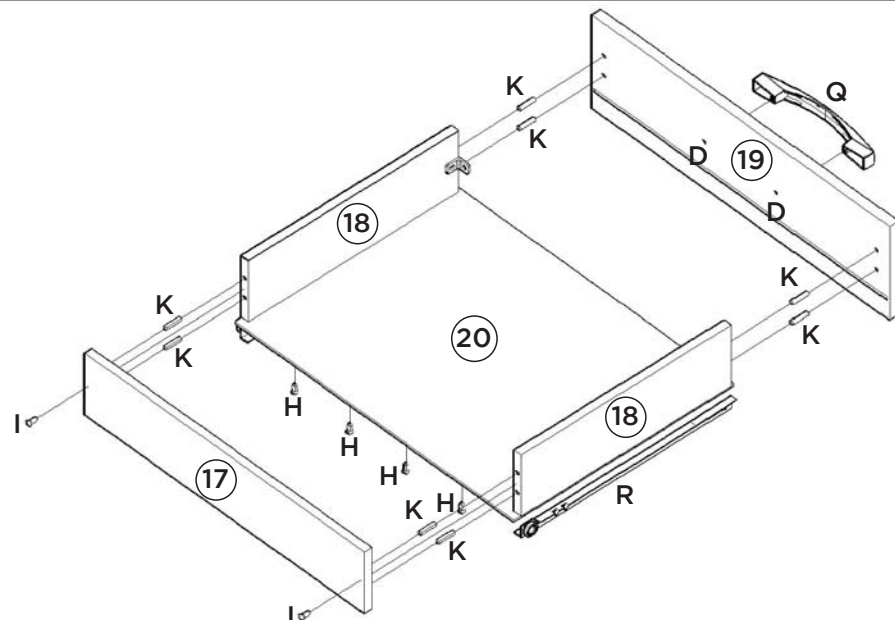
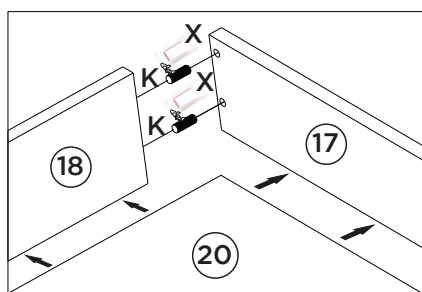
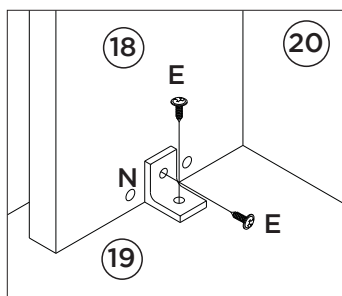
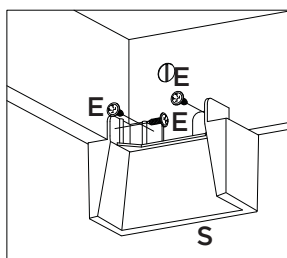







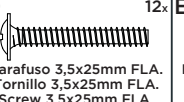
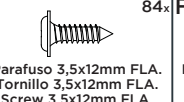

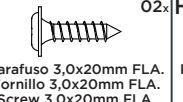

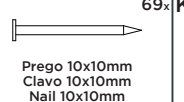







Colocação dos pés "U" (S).  
 La colocación de los pies "U" (S).  
 Placement of the "U" feet (S).

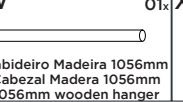

Item	Caixa Caja Box	Qtd Ctd Qty	Descrição   Descripción   Description	Medidas (mm)   Dimensions (mm)   Size (measurements) (mm)
01	1/2	01	Rodapé frontal   Pie frontal   Front footboard	1062x120x12
02	1/2	01	Travessa do rodapé   Carril pie   Footboard tray	415x120x12
03	1/2	01	Rodapé traseiro   Pie trasero   Rear footboard	1062x120x12
04	1/2	01	Lateral direita   Lateral derecho   Right side	1800x445x15
05	1/2	01	Base   Base   Base	537x445x12
06	1/2	01	Divisão das gavetas   División de cajones   Drawers division	300x445x12
07	1/2	01	Tampa da cômoda   Cubierta aparador   Dresser top	1062x445x12
08	1/2	01	Pilastra da porta   Puerta Pilastra   Door pilaster	956x125x12
09	1/2	01	Lateral esquerda   Lateral izquierdo   Left side	1800x445x15
10	1/2	01	Chão do maleiro   Planta de la taquilla de equipaje   Luggage rack floor	1062x445x12
11	1/2	01	Ripa do maleiro   Portaequipajes de ripa   Luggage rack batten	300x68x12
12	1/2	01	Tampo   Cubierta   Cover	1062x455x12
13	2/2	02	Fundo   Fondo   Bottom	1604x542x3
14	1/2	01	Chapéu   Sombrero   Hat	1090x80x15
15	2/2	02	Porta menor   puerta más pequeña   Smaller door	1276x265x15
16	2/2	02	Porta   Puerta   Door	1588x265x15
17	2/2	02	Frente de gaveta   Frente de cajón   Drawer front	533x152x15
18	1/2	04	Lado de gaveta   Lado del cajón   Drawer side	350x100x12
19	1/2	02	Ripa de trás   Malla detrás   Rear batten	500x100x12
20	1/2	02	Fundo de gaveta   Fondo del cajón   Drawer bottom	499x367x3

FERRAGENS | HERRAJES | HARDWARE

 08x Parafuso 4,5x50mm CHT. Tornillo 4,5x50mm CHT. Screw 4,5x50mm CHT.	 02x Parafuso 4,0x22mm FLA. Tornillo 4,0x22mm FLA. Screw 4,0x22mm FLA.	 16x Parafuso 3,5x40mm CHT. Tornillo 3,5x40mm CHT. Screw 3,5x40mm CHT.	 12x Parafuso 3,5x25mm FLA. Tornillo 3,5x25mm FLA. Screw 3,5x25mm FLA.	 84x Parafuso 3,5x12mm FLA. Tornillo 3,5x12mm FLA. Screw 3,5x12mm FLA.	 12x Parafuso 3,5x12mm CHT. Tornillo 3,5x12mm CHT. Screw 3,5x12mm CHT.	 02x Parafuso 3,0x20mm FLA. Tornillo 3,0x20mm FLA. Screw 3,0x20mm FLA.	 16x Parafuso 3,0x16mm CHT. Tornillo 3,0x16mm CHT. Screw 3,0x16mm CHT.
 04x Prego 12x12mm Anelado Clavo 12x12mm Anillado Ringed Nails 12x12mm	 69x Prego 10x10mm Clavo 10x10mm Nail 10x10mm	 44x Cavilha 5x25mm Cinta 5x25mm Dowel 5x25mm	 08x Porca cilíndrica Tuerca cilíndrica Cylindrical nut	 02x Porca Sextavada Tuerca Hexagonal Hexagon Nut	 11x Cantoneira plástica Cantonera plástica Plastic angle brackets	 12x Calço metal 5mm Calzado metálico 5mm 5mm metal shim	 12x Dobradiça metal 26mm Bisagra de metal 26mm 26mm metal hinge
 06x Puxador Indonésia 128mm Tirador Indonésia 128mm 128mm Indonésia Handle	 02x Corrediça metal 350mm Corredora de metal 350mm Sliding metal 350mm	 06x Pé "U" 50x40x100mm Pie "U" 50x40x100mm 50x40x100mm "U" feet	 01x Suporte cabideiro "U" Soporte de percha "U" "U" Coat hanger support	 02x Suporte cabideiro Soporte de percha Coat hanger support	 01x Perfil "I" 1589mm Perfil "I" 1589mm Profile "I" 1589mm	 01x Cabideiro Madeira 1056mm Cabezal Madera 1056mm 1056mm wooden hanger	 01x Sachê de cola Bolsa de pegamento Glue bag
 24x Adesivo tapa parafuso 10mm Adhesivo tapón de tornillo 10mm Bolt cover adhesive 10mm	 01x Etiqueta resinada Briz Etiqueta resinada Briz Briz resin label						

AVISO

Para limpeza de seu móvel, use uma flanela seca ou umedecida, e não utilize produtos químicos que possam danificar seu produto.

SISTEMA DE MONTAGEM

O sistema de montagem dos produtos, funciona de acordo com a ordem crescente dos números indicados no desenho. Ex: 01, 02, 03, 04... até a conclusão da montagem.

ADVERTENCIA

Para limpieza de su móvil, use una franela seca o húmeda, y no utilice productos químicos que puedan dañar su producto.

SISTEMA DE MONTAJE

El sistema de montaje de los productos funciona de acuerdo con el orden creciente de los números indicados en el dibujo. Ej.: 01, 02, 03, 04... hasta la conclusión del montaje.

NOTICE

To clean your furniture, use a dry or wet cloth, and do not use chemicals that may damage your product.

ASSEMBLY SYSTEM

The products' assembly system works according to the increasing order of the indicated numbers. For example: 01, 02, 03, 04 ... to the end of the assembly.