



Ind. e Com. de Móveis Henn
Mondai - SC - Brasil

+55 49 3674.3500

@moveishenn
www.henn.com.br

INSTRUÇÕES DE MONTAGEM

INSTRUCCIONES DE MONTAJE
ASSEMBLY INSTRUCTIONS

Roupeiro 04 Portas 02 Gavetas | Armario 04 puertas y 02 cajones | Wardrobe 04 Doors 02 Drawers

BS07-127 - Nature/Off White

BS07-198 - Jequitibá Brilho

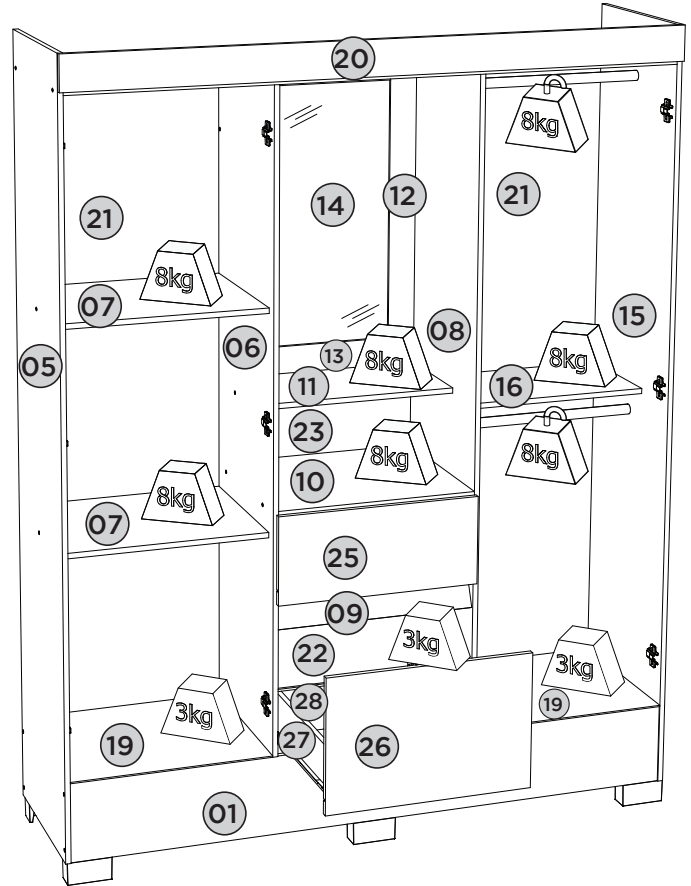

Pesos máximos recomendados com carga distribuída
Peso máximo recomendado con la carga distribuida
Recommended maximum weights with evenly distributed.

Requisitos para montagem Requisitos para la montaje Assembly Requirements

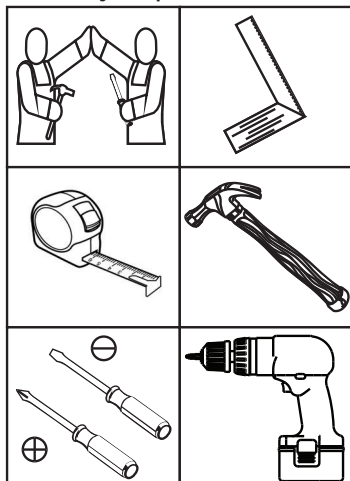

Imagens meramente ilustrativas,
não acompanha o produto.
Imágenes ilustrativas, no incluidas
con el producto.
Illustrative images, not included
with the product.

AVISO

Para limpeza de seu móvel, use uma flanela seca ou umedecida, e não utilize produtos químicos que possam danificar seu produto.

SISTEMA DE MONTAGEM

O sistema de montagem dos produtos, funciona de acordo com a ordem crescente dos números indicados no desenho. Ex: 01, 02, 03, 04... até a conclusão da montagem.

ASSISTÊNCIA TÉCNICA

Para solicitação de Assistência Técnica você consumidor deverá entrar em contato com o Lojista o qual você realizou a compra deste produto e solicitar a assistência técnica das peças avariadas. A garantia abrange todas as peças, partes e componentes que eventualmente venham apresentar defeito de fabricação no prazo de 03 (três) meses, contando a partir da entrega do produto ao consumidor, mediante nota fiscal de compra. Se houver qualquer alteração na estrutura do produto ou ocorrer defeito por negligência do montador/consumidor em relação a instrução de montagem e manuseio, não será fornecido assistência técnica gratuita.

ADVERTENCIA

Para limpieza de su móvil, use una flanela seca o húmeda, y no utilice productos químicos que puedan dañar su producto.

SISTEMA DE MONTAJE

El sistema de montaje de los productos funciona de acuerdo con el orden creciente de los números indicados en el dibujo. Ej: 01, 02, 03, 04... hasta la conclusión del montaje.

ASISTENCIA TÉCNICA

Para solicitar Asistencia Técnica, el consumidor debe comunicarse con el Comercio que usted realizó la compra de este producto y solicita asistencia técnica para las partes dañadas. La garantía cubre todas las partes, piezas y componentes que eventualmente puedan presentar defecto de fabricación en el plazo de 03 (tres) meses, contados a partir de la entrega del producto al consumidor, mediante factura de compra. Si se produce algún cambio en la estructura del producto o se produce un defecto por negligencia del montador/consumidor en relación con las instrucciones de montaje y manipulación, no se prestará asistencia técnica gratuita.

NOTICE

To clean your furniture, use a dry or wet cloth, and do not use chemicals that may damage your product.

ASSEMBLY SYSTEM

The products' assembly system works according to the increasing order of the indicated numbers. For example: 01, 02, 03, 04 ... to the end of the assembly.

TECHNICAL ASSISTANCE

To request Technical Assistance, the consumer must contact the retailer from whom you purchased this product and request technical assistance for the damaged parts. The warranty covers all parts, parts and components that may eventually present a manufacturing defect within a period of 03 (three) months, counting from the delivery of the product to the consumer, by means of a purchase invoice. If there is any change in the structure of the product or defect occurs due to negligence of the assembler/consumer in relation to the assembly and handling instruction, free technical assistance will not be provided.

1

Vista Inferior

Vista Inferior

Bottom view

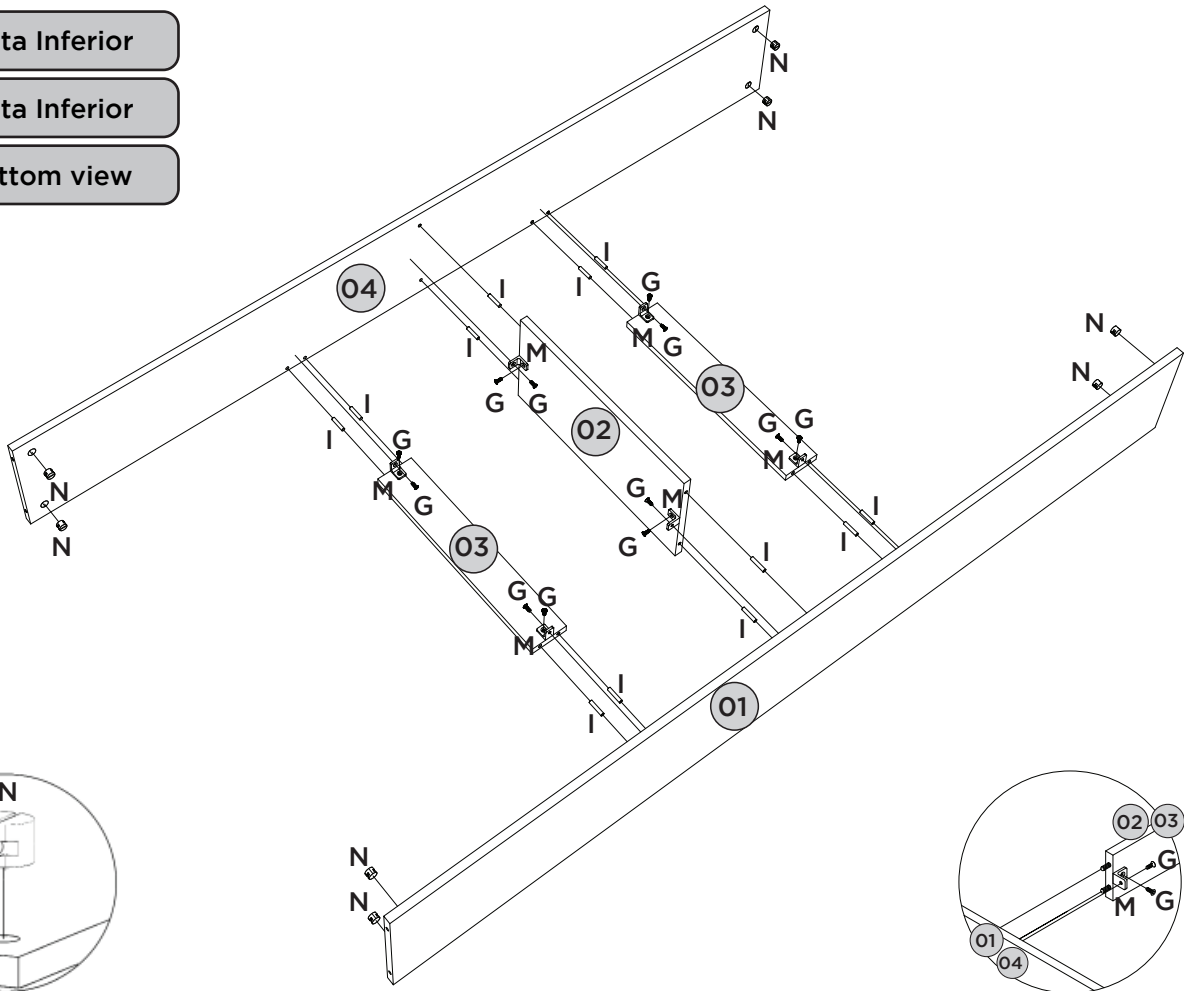

2

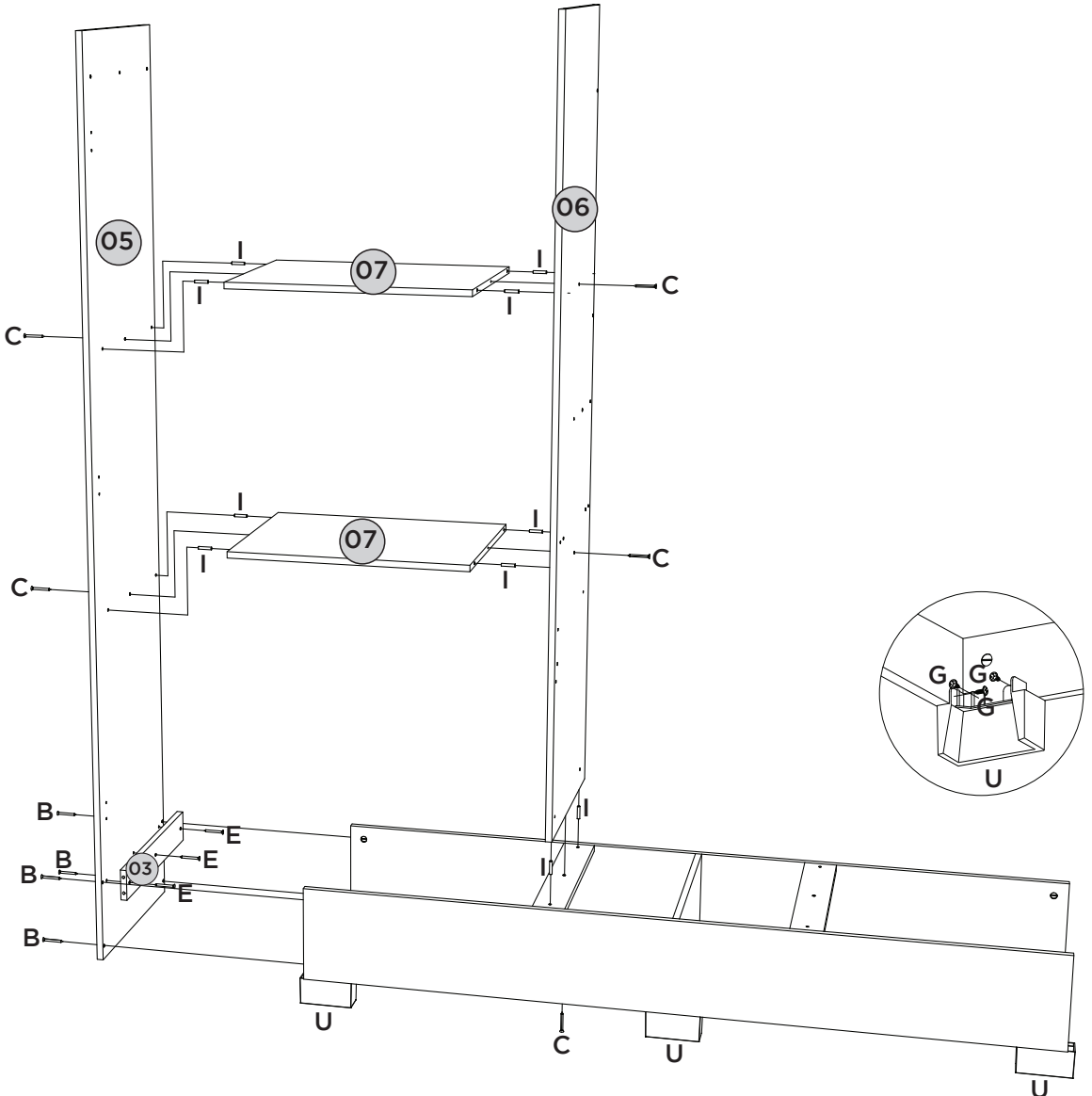

3

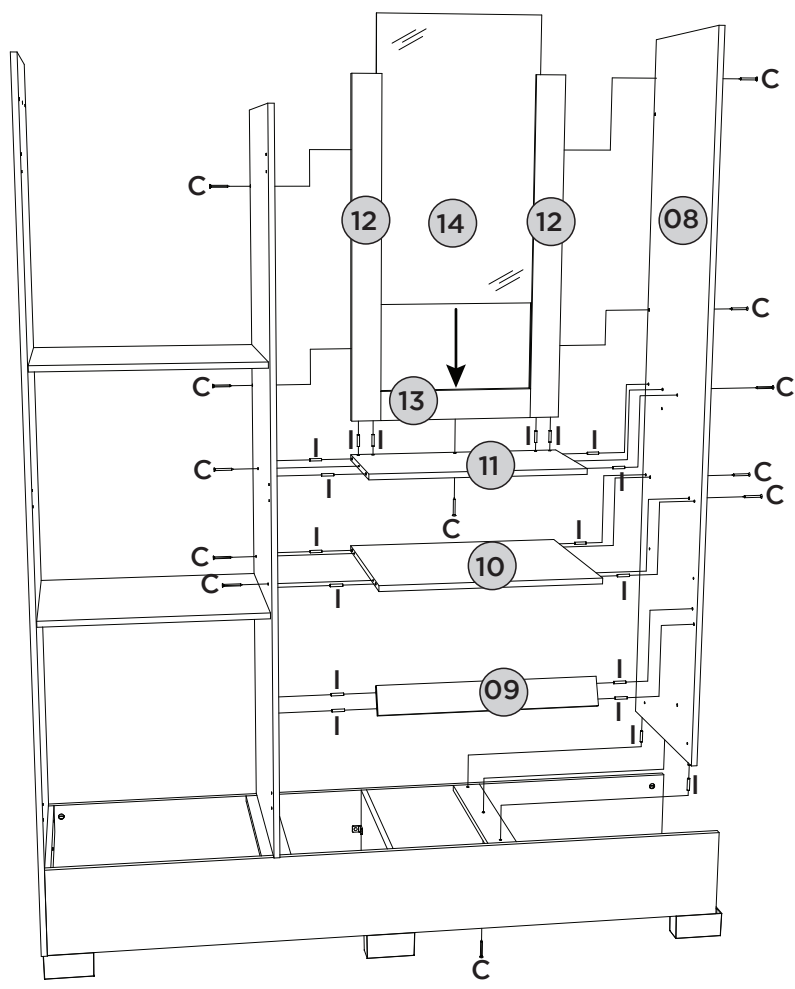

4

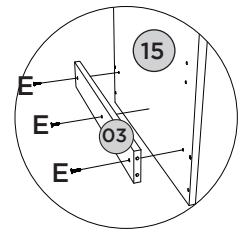
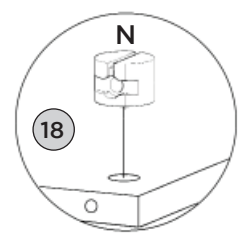
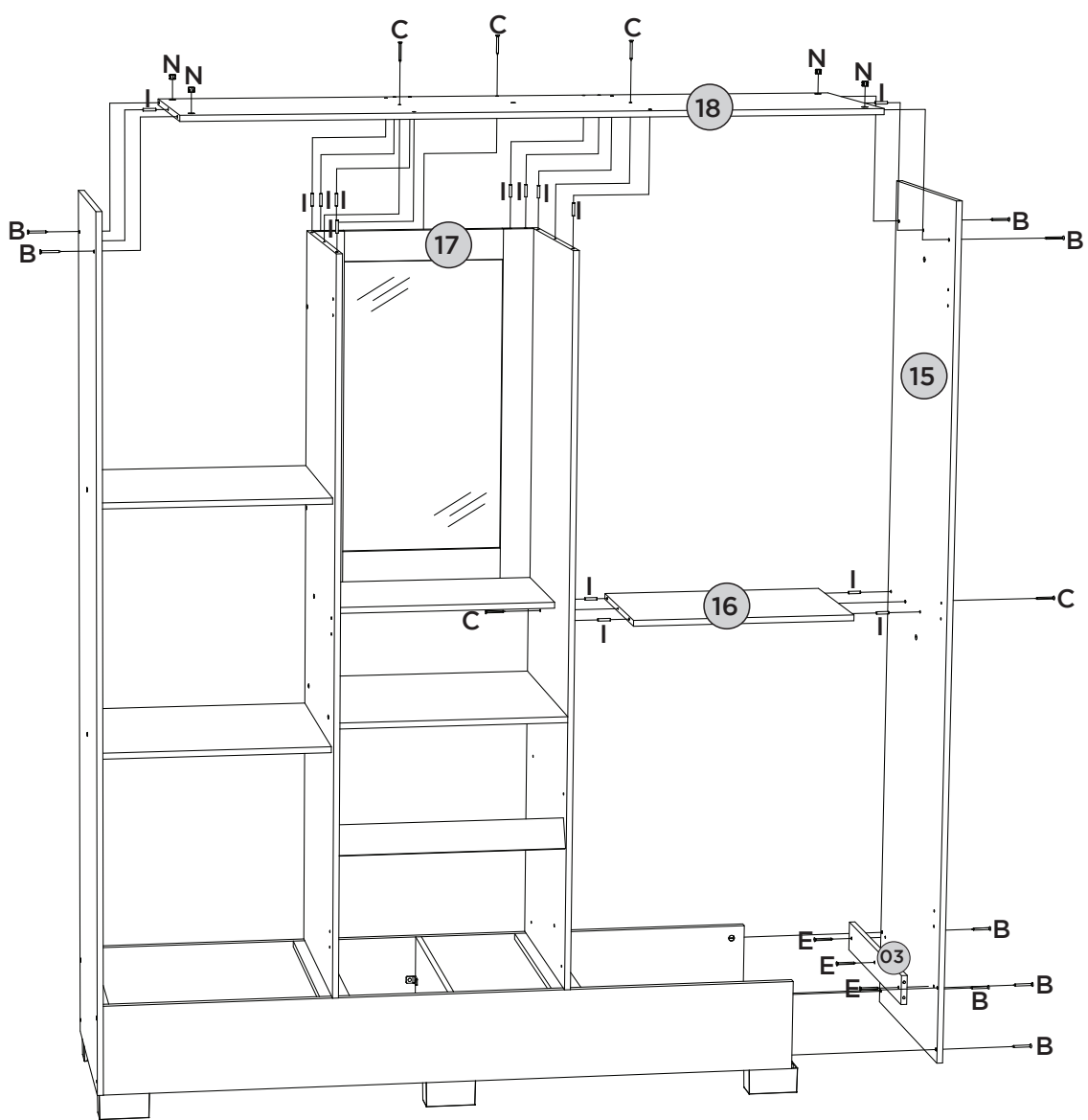

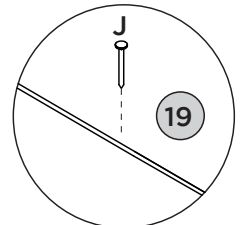
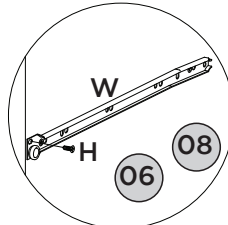
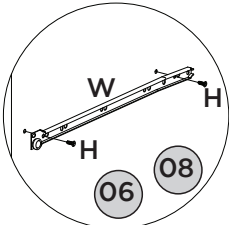
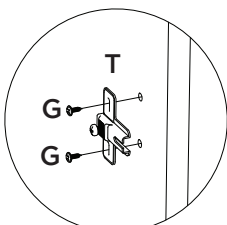
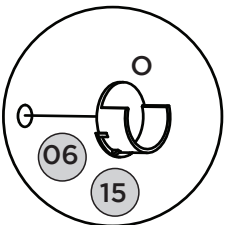
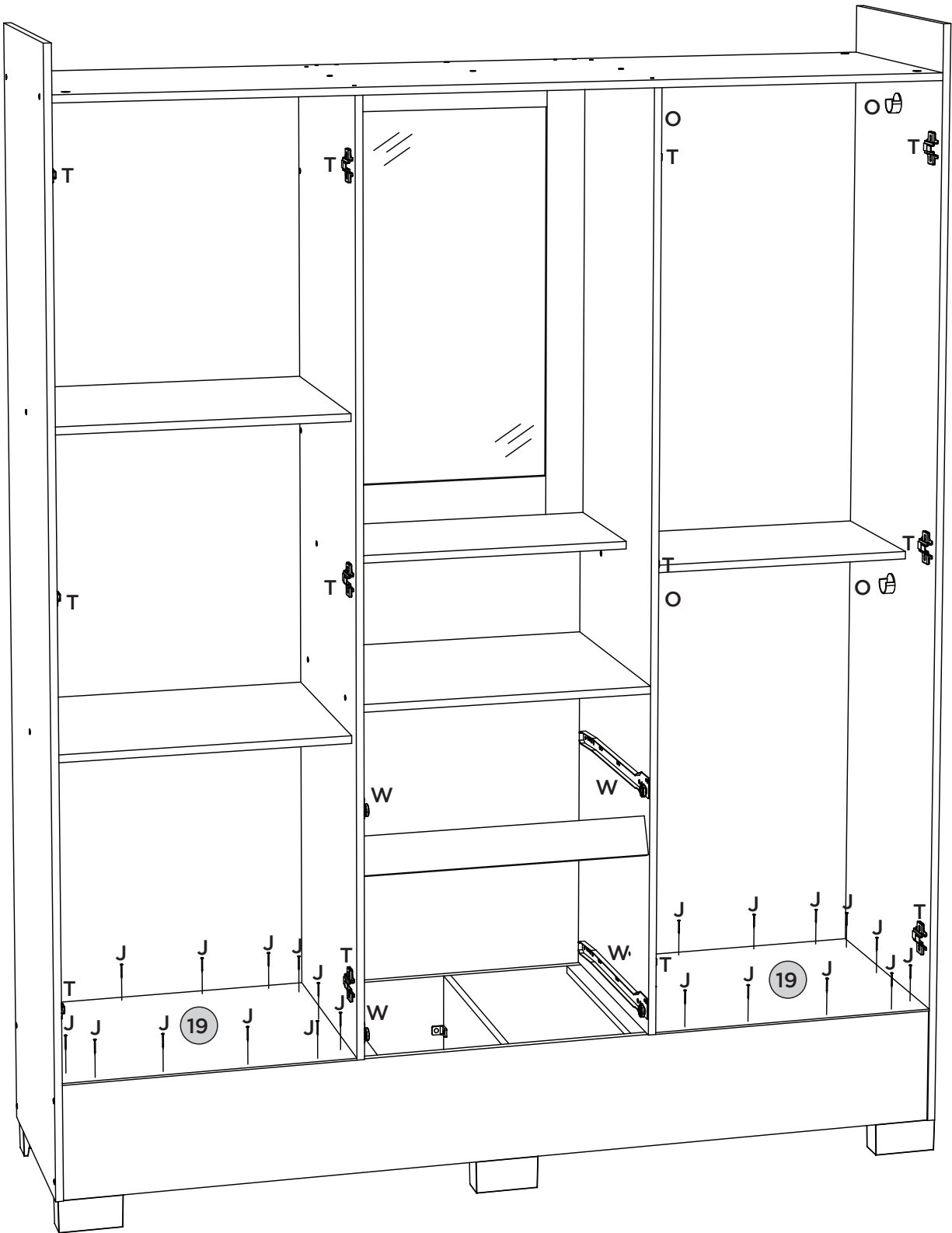

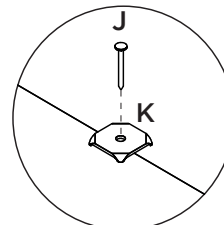
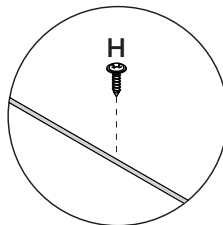
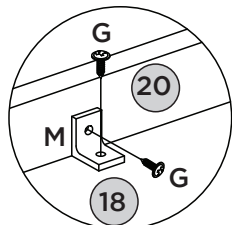
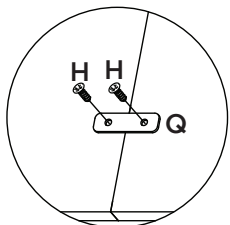
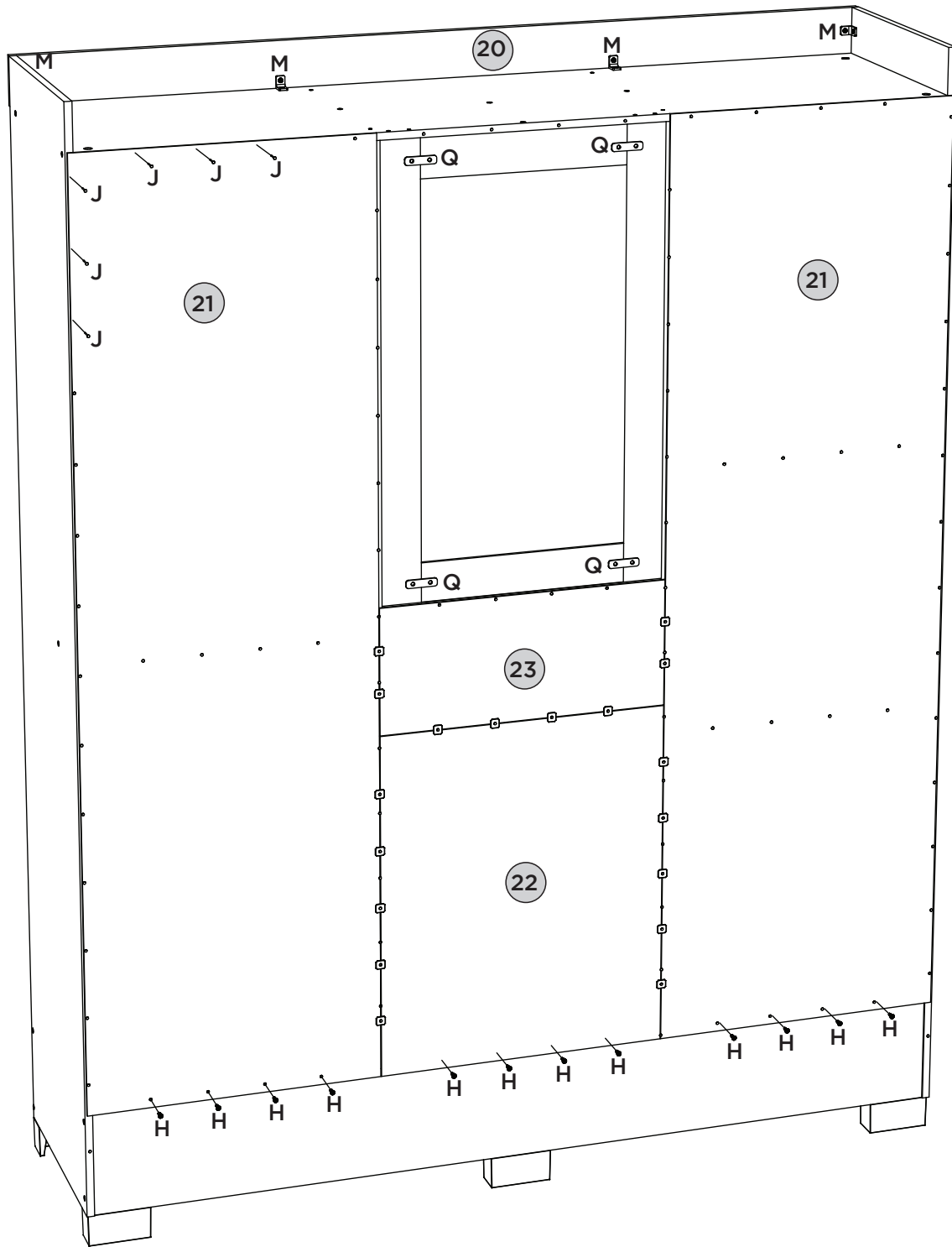

Fixar os pregos a uma distância de 120mm de um para outro.

Fijar las uñas a un distancia de 120mm uno a otro.

Fix the nails at a distance of 120mm from one to the other

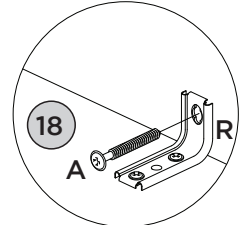
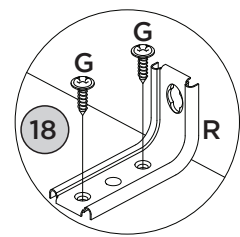
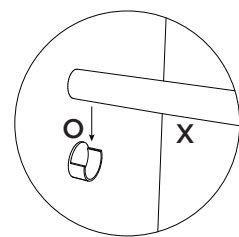
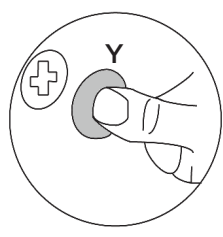
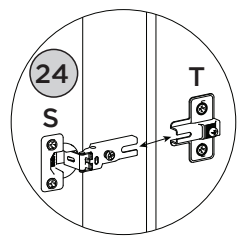
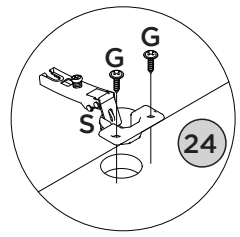

8

Vista Inferior
 Vista Inferior
 Bottom view

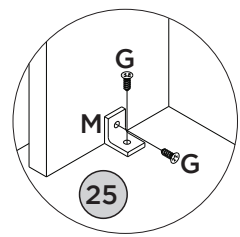
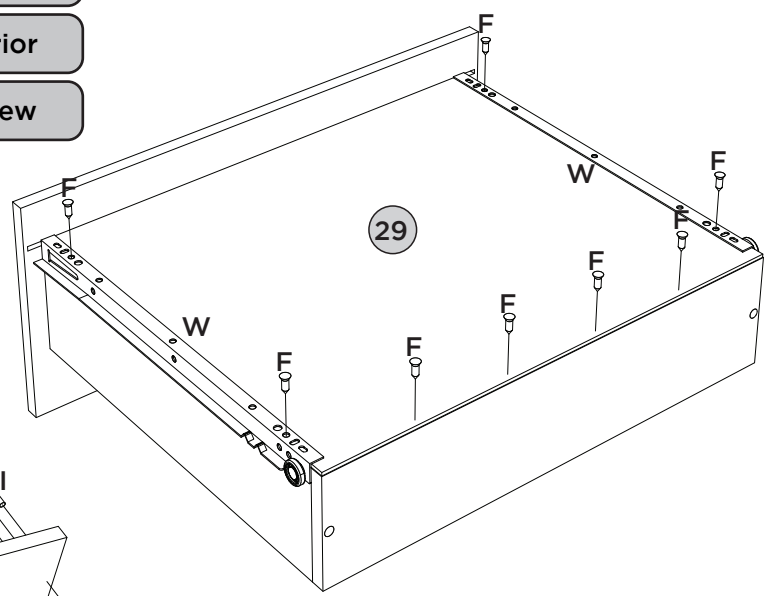
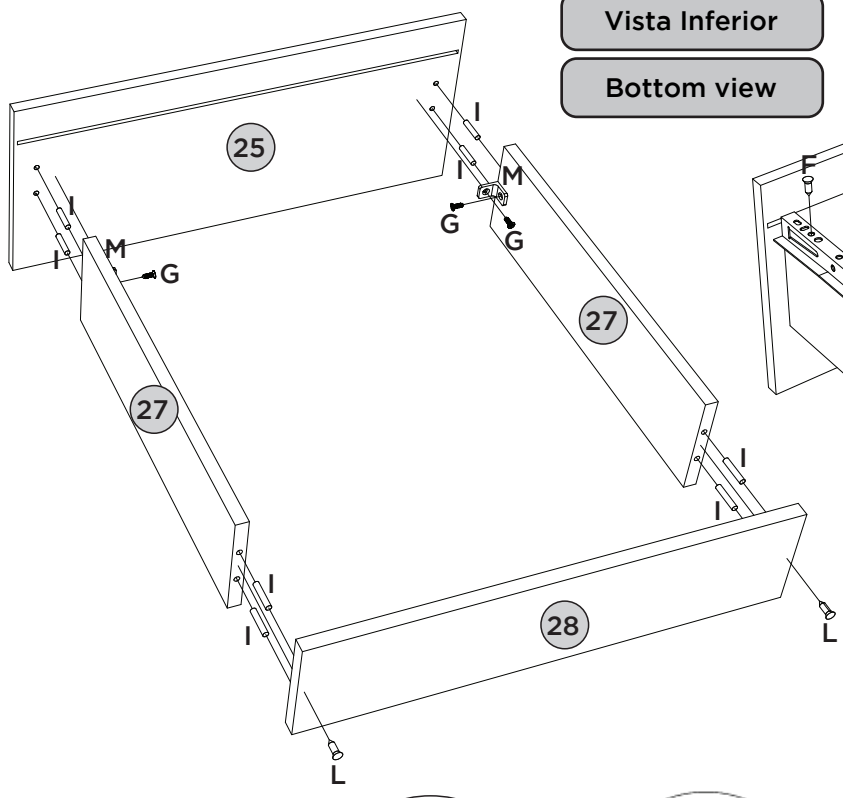





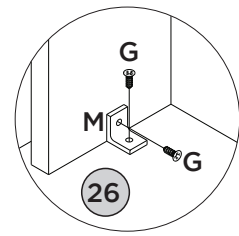
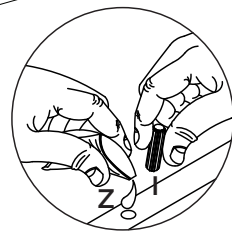
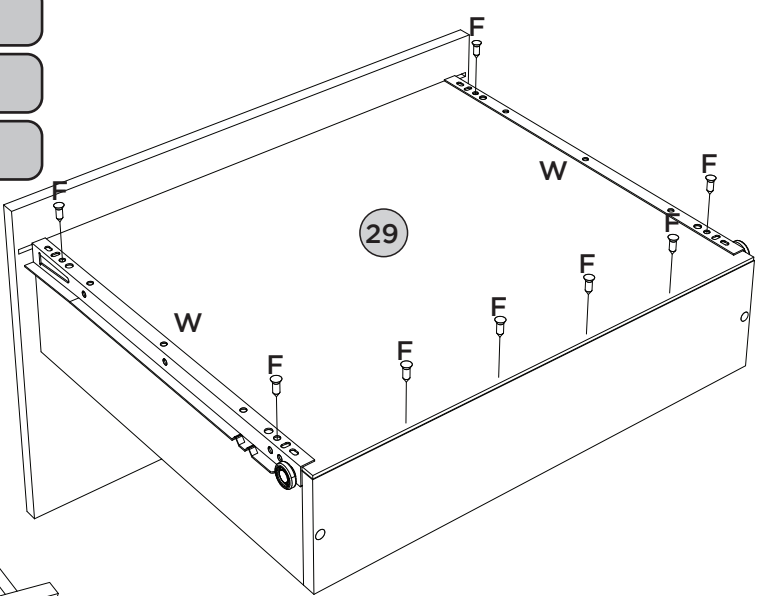
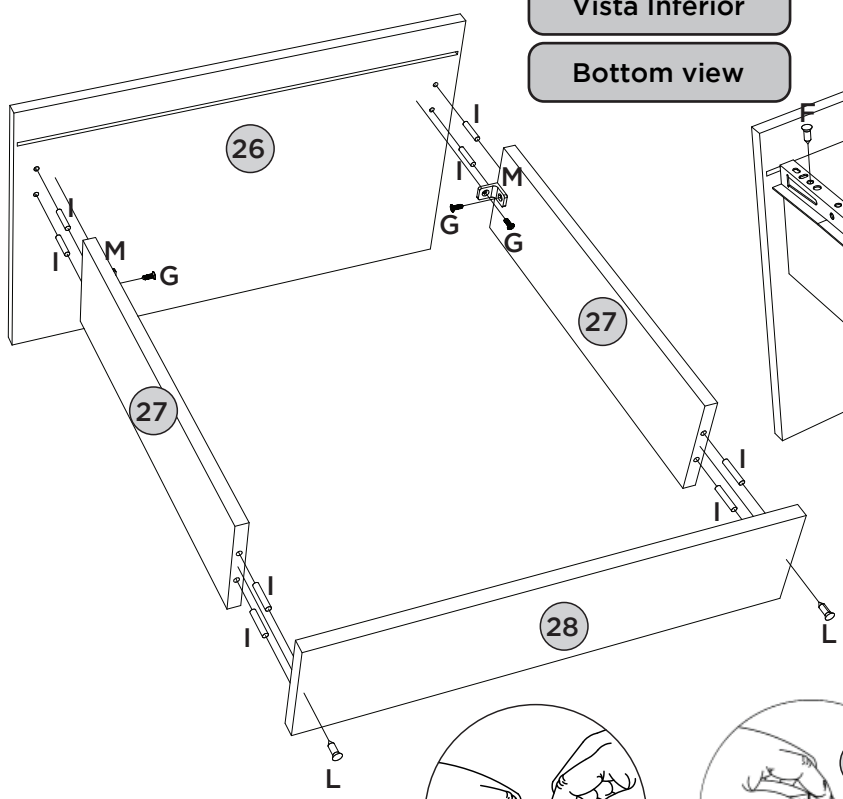





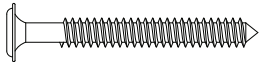







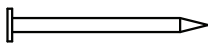

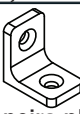

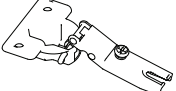
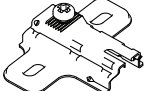

9

Vista Inferior
 Vista Inferior
 Bottom view

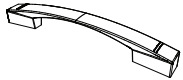

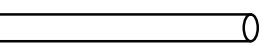
Item	Caixa Caja Box	Qtd Ctd Qty	Descrição Descripción Description	Medidas (mm) Dimensions (mm) Size (measurements) (mm)
01	1/2	01	Rodapé Frontal Rodapié Frontal Front baseboard	1389x180x12
02	1/2	01	Travessa do rodapé Carril pie Baseboard crosspiece	350x180x12
03	1/2	04	Travessa Base travesaño base base crosspiece	354x60x12
04	1/2	01	Rodapé Traseiro Rodapié trasero Rear baseboard	1389x180x12
05	1/2	01	Lateral esquerda Lateral izquierda Left side	1750x380x12
06	2/2	01	Divisão esquerda División izquierda Left division	1482x380x12
07	1/2	02	Prateleira Estante Shelf	455x350x12
08	2/2	01	Divisão direita División derecha Right division	1482x380x12
09	1/2	01	Travessa Frontal Travesaño delantero Front Tray	455x60x12
10	1/2	01	Tampo das Gavetas Cubre los cajones Drawer Top	455x380x12
11	1/2	01	Prateleira Externa Estante externo External Shelf	455x250x12
12	2/2	02	Moldura lateral Cornija lateral Side frame	726x63x15
13=17	2/2	01	Moldura Inferior Superior Cornija Inferior Superior Top Bottom Frame	329x63x15
14	2/2	01	Espelho Espejo Mirror	600x350x3
15	1/2	01	Lateral direita Lateral derecha Right side	1750x380x12
16	1/2	01	Prateleira do calceiro Estante de calceiro Calceiro's shelf	455x250x12
17=13	2/2	01	Moldura Inferior Superior Cornija Inferior Superior Top Bottom Frame	329x63x15
18	1/2	01	Tampo Topo top	1389x380x12
19	2/2	02	Base 3mm Base 3mm Base 3mm	455x380x3
20	1/2	01	Chapéu Sombrero Hat	1411x80x12
21	2/2	02	Fundo Fondo Bottom	1506x470x3
22	2/2	01	Fundo cru Fondo sin procesar Raw bottom	560x465x3
23	2/2	01	Fundo Externo Fondo Externo External Fund	465x205x3
24	2/2	04	Porta Puerta Door	1491x230x12
25	1/2	01	Frente de gaveta Frente de cajón Front of drawer	463x200x12
26	1/2	01	Frente de gaveta maior Frente de cajón mayor Largest drawer front	463x300x12
27	1/2	04	Lado de gaveta Lado del cajón Side of drawer	350x100x12
28	1/2	02	Ripa de trás Malla detrás Rear lath	430x100x12
29	2/2	02	Fundo de gaveta Fondo del cajón Fondo de cajón	429x367x3

FERRAGENS | HERRAJES | HARDWARE

A  Parafuso 5,0x50mm FLA. Tornillo 5,0x50mm FLA. Screw 5,0x50mm FLA.	01x	B  Parafuso 4,5x50mm CHT. Tornillo 4,5x50mm CHT. Screw 4,5x50mm CHT.	12x	C  Parafuso 3,5x40mm CHT. Tornillo 3,5x40mm CHT. Screw 3,5x40mm CHT.	22x	D  Parafuso 3,5x25mm FLA. Tornillo 3,5x25mm FLA. Screw 3,5x25mm FLA.	08x	E  Parafuso 3,0x20mm CHT. Tornillo 3,0x20mm CHT. Screw 3,0x20mm CHT.	06x
F  Parafuso 3,0x16mm CHT. Tornillo 3,0x16mm CHT. Screw 3,0x16mm CHT.	16x	G  Parafuso 3,5x12mm FLA. Tornillo 3,5x12mm FLA. Screw 3,5x12mm FLA.	96x	H  Parafuso 3,5x12mm CHT. Tornillo 3,5x12mm CHT. Screw 3,5x12mm CHT.	32x	I  Cavilha 5x25mm Cinta 5x25mm Dowel 5x25mm	70x	J  Prego 10x10mm Clavo 10x10mm Nail 10x10mm	95x
K  Fixador de fundos Fijador de fondos Bottom fixer	15x	L  Prego 12x12mm Anelado Clavo 12x12mm Anillado Ringed Nails 12x12mm	04x	M  Cantoneira plástica Cantonera plástica Plastic angle brackets	14x	N  Porca cilíndrica Tuercas cilíndrica Cylindrical nut	12x	O  Suporte cabideiro meia cana Soporte de percha Coat hanger support	04x
P  Bucha plástica 8mm Bucha de plástico 8mm 8mm plastic bushing	01x	Q  Suporte de metal Soporte de metal Metal stands	04x	R  Suporte de fixação Soporte de fijación Mounting bracket	01x	S  Dobradiça L2 26mm Bisagra L2 26mm 26 mm L2 hinge	12x	T  Calço metal 5mm Calzado metálico 5mm 5 mm metal shim	12x
U  Pé "U" 50x40x100mm Pie "U" 50x40x100mm 50x40x100mm "U" feet	06x	V  Puxador Indonésia 128mm Tirador Indonésia 128mm 128mm Indonésia Handle	04x	W  Corrediça metal 350mm Corredera de metal 350mm Sliding metal 350mm	02x	X  Cabideiro Madeira 449mm 449 mm de suspensión de madeira 449 mm wooden hanger	02x	Y  Adesivo tapa parafuso 10mm Adhesivo tapón de tornillo 10mm Bolt cover adhesive 10mm	28x
Z  Sachê de cola Bolsa de pegamento Glue bag	01x	AA  Etiqueta resinada Briz Etiqueta resinada Briz Briz resin label	01x						