

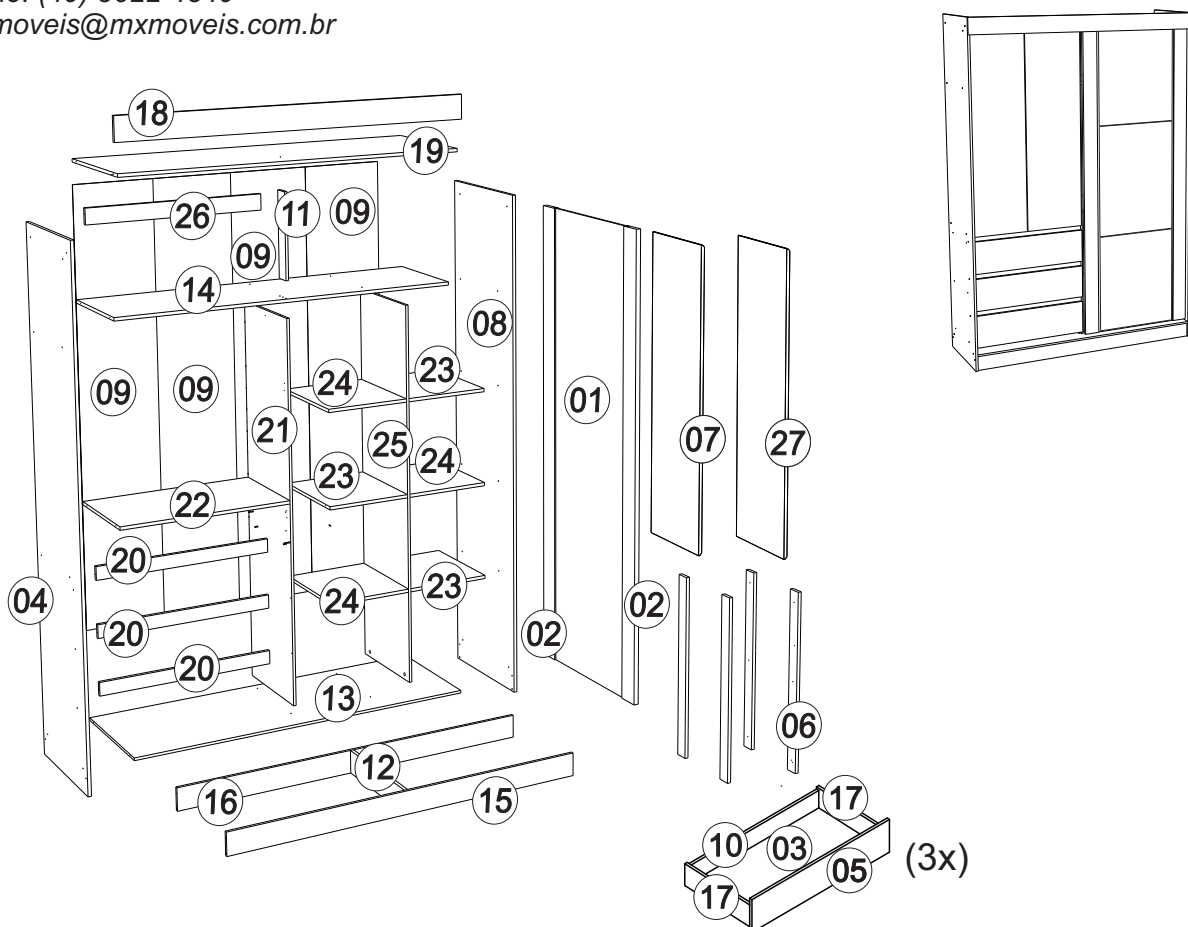

## Roupeiro Bagda





Nº	CÓDIGO ASSISTÊNCIA	NOME DA PEÇA/DESCRIPCIÓN PIEZAS	MEDIDAS (mm)	QTD.	CASTANHO OFF WHITE
01	RD032.24.01	Montante porta/Puerta	2128x623x09	01	263330
02	RD032.24.00	Montante porta/Puerta	2128x100x22	02	263361
03	RD032.34.00	Forro gaveta/Fondo cajón	725x355x2.5	03	259224
04	RD032.18.00	Lateral externa esquerda/Lateral izquierda	2325x544x15	01	262710
05	RD032.14.00	Frente gaveta/Frente cajón	777x220x15	03	263340
06	RD032.09.00	Distanciador gaveta	781x70x15	04	259456
07	RD032.25.00	Porta dir	1322x387x15	01	262753
08	RD032.17.00	Lateral externa direita/Lateral derecha	2325x544x15	01	262709
09	RD032.13.00	Forro/Revés	2160x396x2.5	04	259223
10	RD032.29.00	Ripa traseira de gaveta/Trasero cajón	701x80x12	03	259226
11	RD032.06.00	Ripa batente	387x70x12	01	262703
12	RD032.31.00	Rodapé interno	500x100x15	01	259382
13	RD032.01.00	Base inferior/Base inferior	1570x544x12	01	262702
14	RD032.03.00	Base maleiro/Base	1570x453x15	01	262707
15	RD032.30.00	Rodapé frontal	1570x100x12	01	262706
16	RD032.32.00	Rodapé traseiro	1570x100x12	01	259373
17	RD032.15.00	Lateral gaveta/Lateral cajón	350x100x12	06	259369
18	RD032.07.00	Chapéu/Detalle superior	1600x110x15	01	262708
19	RD032.05.00	Base superior/Base superior	1570x544x15	01	263334
20	RD032.28.00	Ripa sustentação	779x60x15	03	262711
21	RD032.19.00	Lateral interna esquerda/Lateral	1746x453x12	01	262704
22	RD032.04.00	Base sob gaveta/Base	779x453x15	01	262673
23	RD032.02.00	Base interna/Base	453x383x15	03	259374
24	RD032.27.00	Prateleira interna	453x383x15	03	259455
25	RD032.19.01	Lateral interna direita/Lateral	1746x453x12	01	263336
26	RD032.28.01	Ripa apoio	779x70x15	01	262712
27	RD032.25.01	Porta esq	1322x387x15	01	265701
28	11631	Espelho	696X577X3	01	265701

# Ferragens/Herrajes

**A**  **22x**  
Cavilha Ø6,0x30mm Cód. 873

**B**  **52x**  
Parafuso 3,5x40mm Cht. Cód. 691

**C**  **61x**  
Parafuso 3,0x12mm Cht. Cód. 11413

**D**  **24x**  
Parafuso 4,0x12mm Cht. Cód. 7604

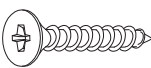
**E**  **12x**  
Parafuso 3,5x25mm Cht. Cód. 692

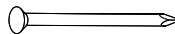
**F**  **161x**  
Prego 8x8 Cód. 822

**G**  **36x**  
Fixador costa Cód. 7169

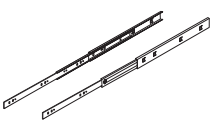
**H**  **03x**  
Corrediças Cód. 20253

**I**  **14x**  
Cantoneira metálica Cód. 7168

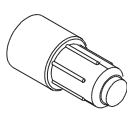
**J**  **12x**  
Suporte prateleira Cód. 790

**K**  **01x**  
Sistema de correr Cód. 2495

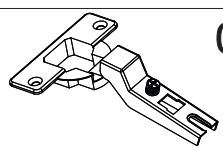
**L**  **06x**  
Dobradiça/Visagra/Metal hinge Cód. 10269

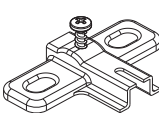
**M**  **03x**  
Calço dobradiça/Calzo de visagra/ Chock to hinge Cód. 12539

**N**  **01x**  
Tubo oblongo 771mm Cód. 11410

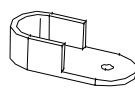
**O**  **02x**  
Suporte cabideiro Cód. 857

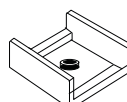
**P**  **04x**  
Sapata 15x15 Cód. 801

**Q**  **02x**  
Perfil 387mm Cód. 11409

**R**  **01x**  
Perfil 2160mm Cód. 11408

**S**  **01x**  
Trilho inferior 1570mm Cód. 11407

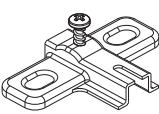
**T**  **03x**  
Calço dobradiça/Calzo de visagra/ Chock to hinge Cód. 18804

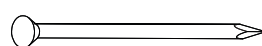
**U**  **04x**  
Prego 12x12 Cód. 821

**V**  **12x**  
Parafuso 3,0x22mm Cht. Cód. 9567

**W**  **04x**  
Parafuso 6,0x30mm Cht. Cód. 701

**X**  **04x**  
Tambor minifix Cód. 700

**Y**  **01x**  
Bisnaga cola Cód. 8255

**Z**  **12x**  
Parafuso 4,0x14mm Cht. Cód. 667

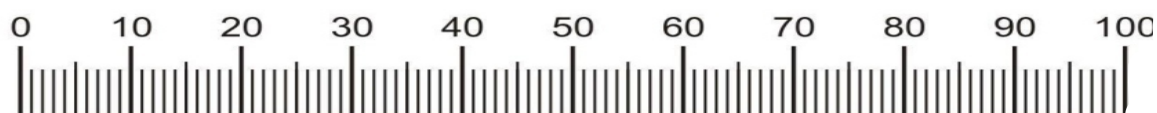

Medidas em mm

# Pré-Montagem/Preparación Piezas

Obs: O trilho superior e inferior devem ser montados a 20mm da borda da base até a ponta do trilho

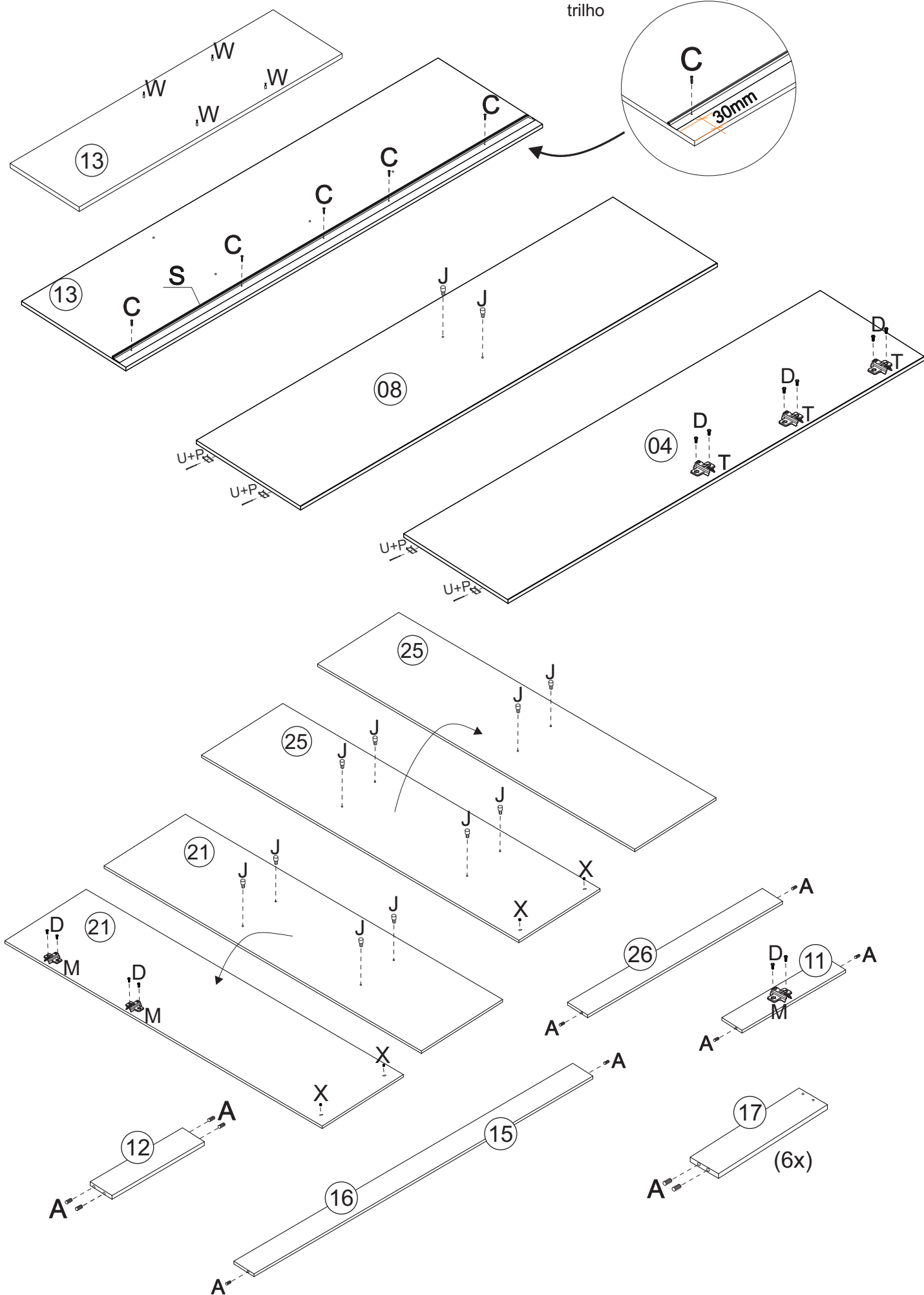

## 01 Montagem/Montaje

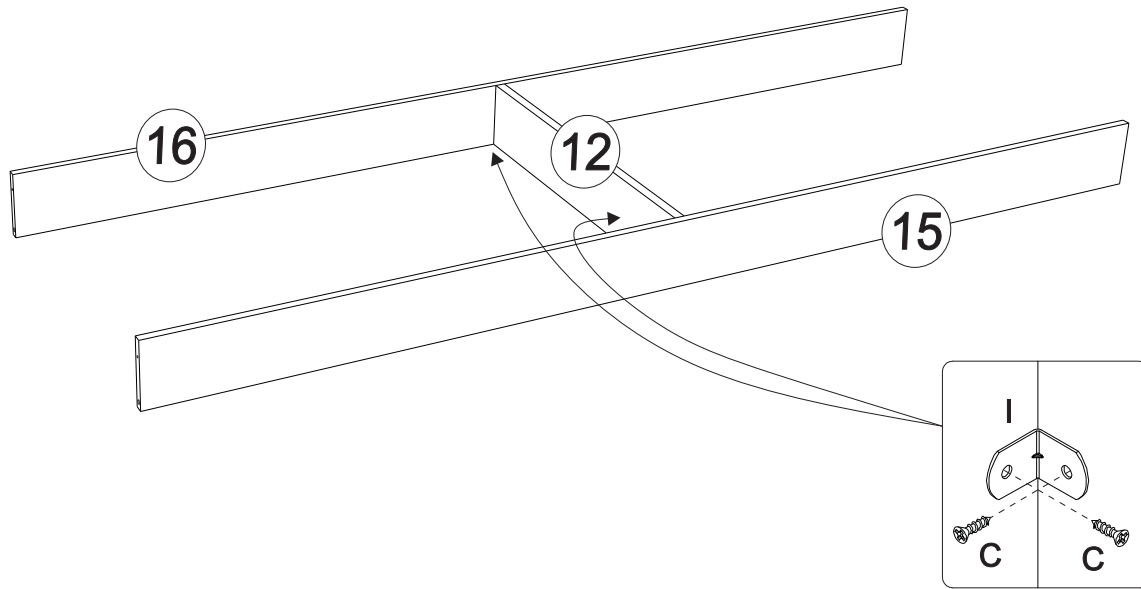

## 02 Montagem/Montaje

Obs: Roupeiro pode ser montado em pé.

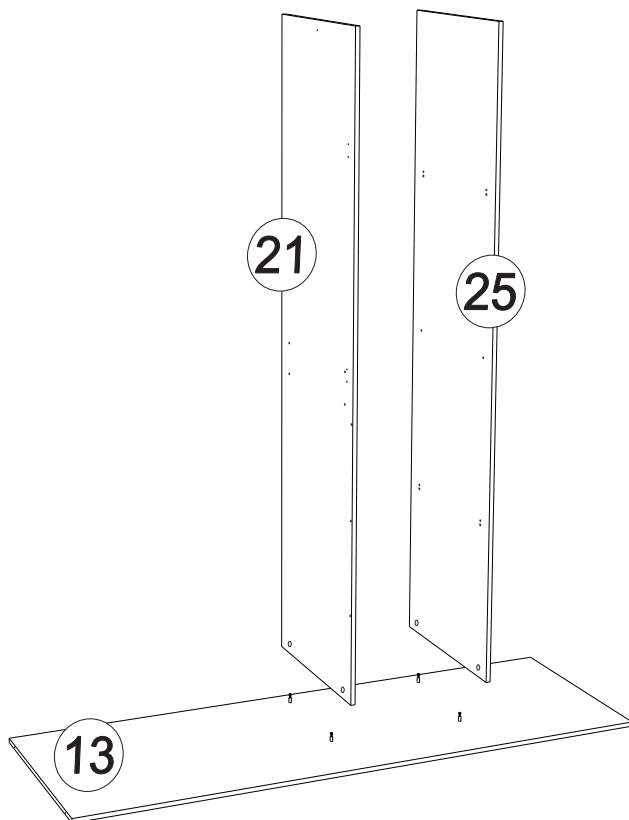

### 03 → Montagem/Montaje

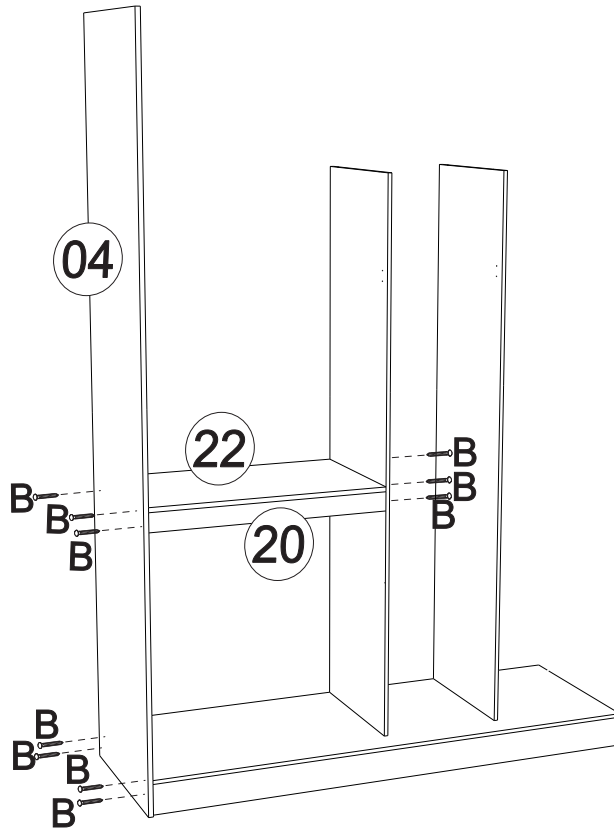

### 04 → Montagem/Montaje

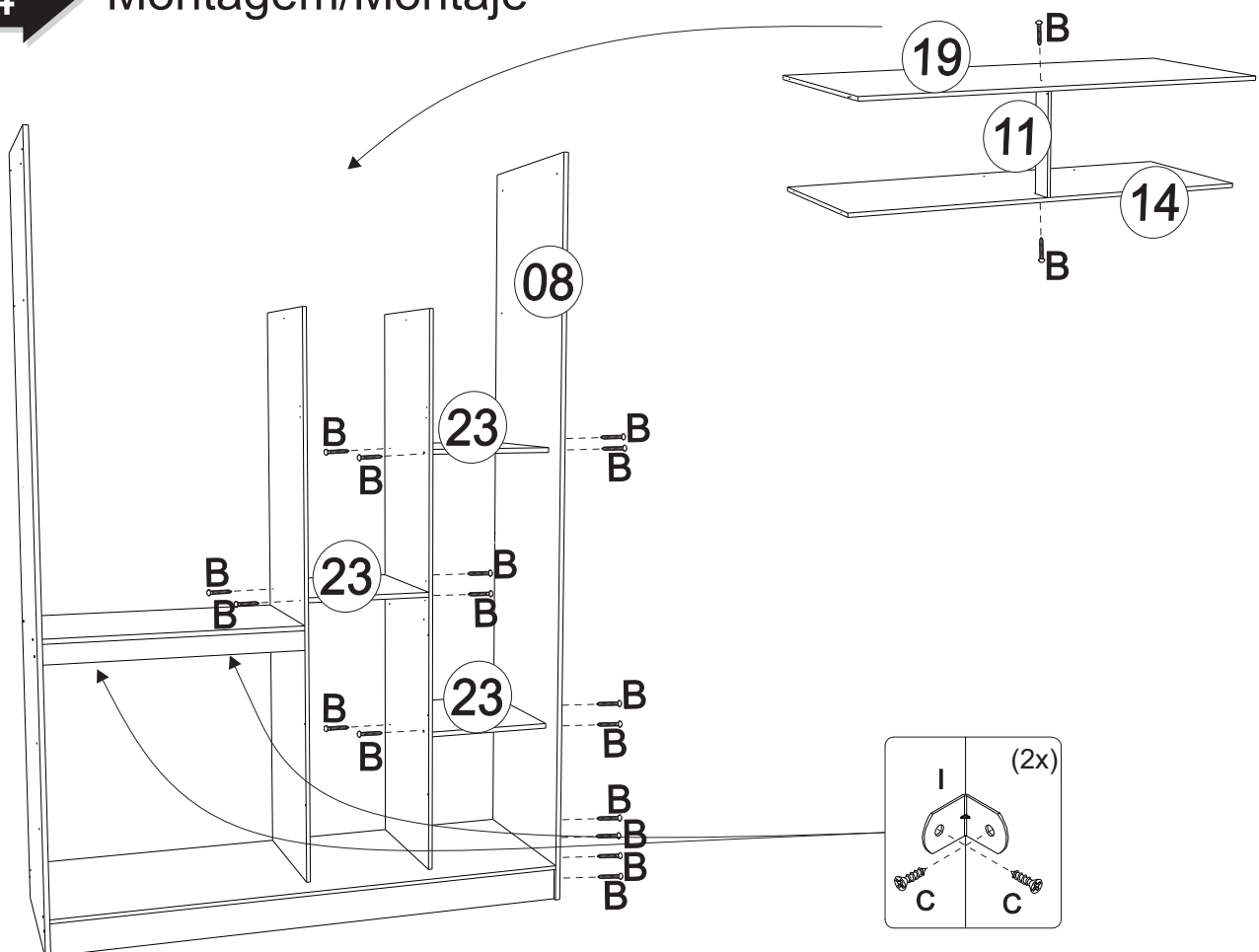

## 05 Montagem/Montaje

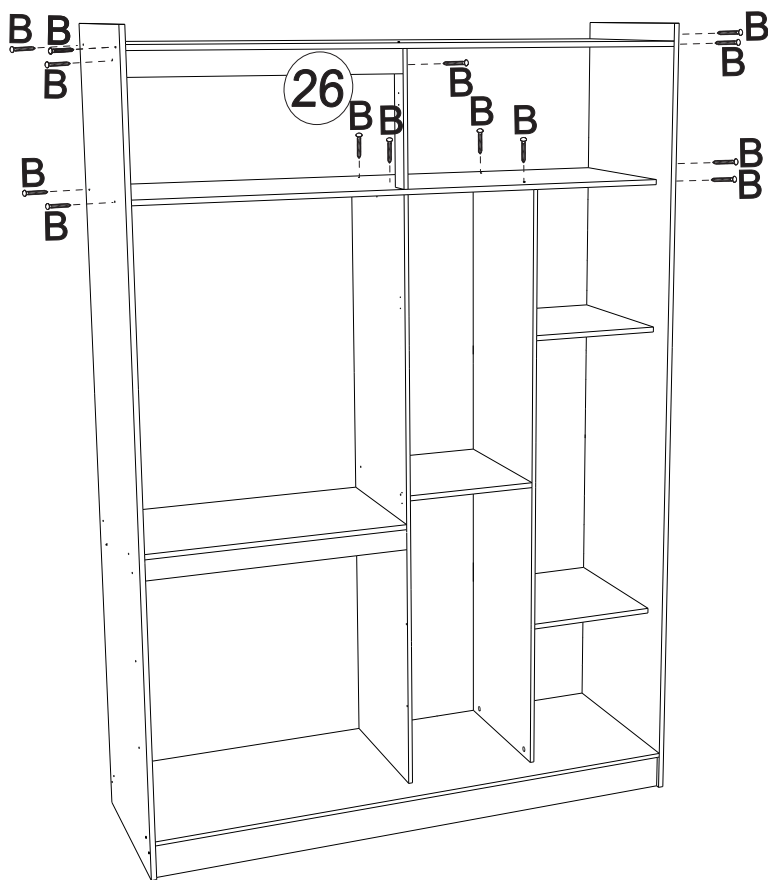

## 06 Montagem/Montaje

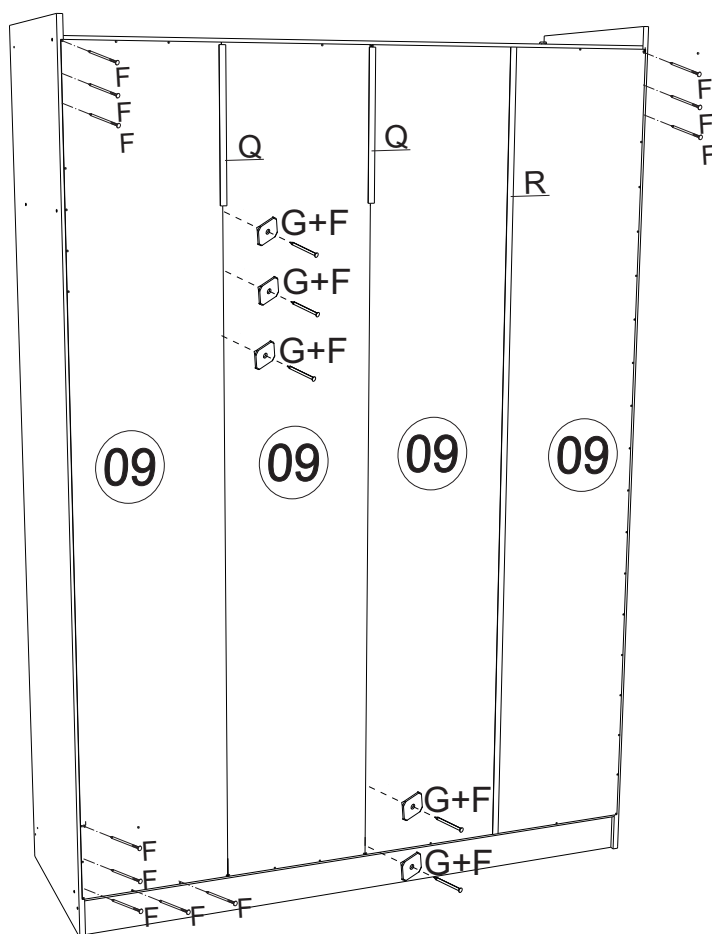

\*Colocar um prego (F)  
a cada 100mm

\*Colocar o prego (F) e a  
junção (G) a cada 100mm

# 07 Montagem/Montaje

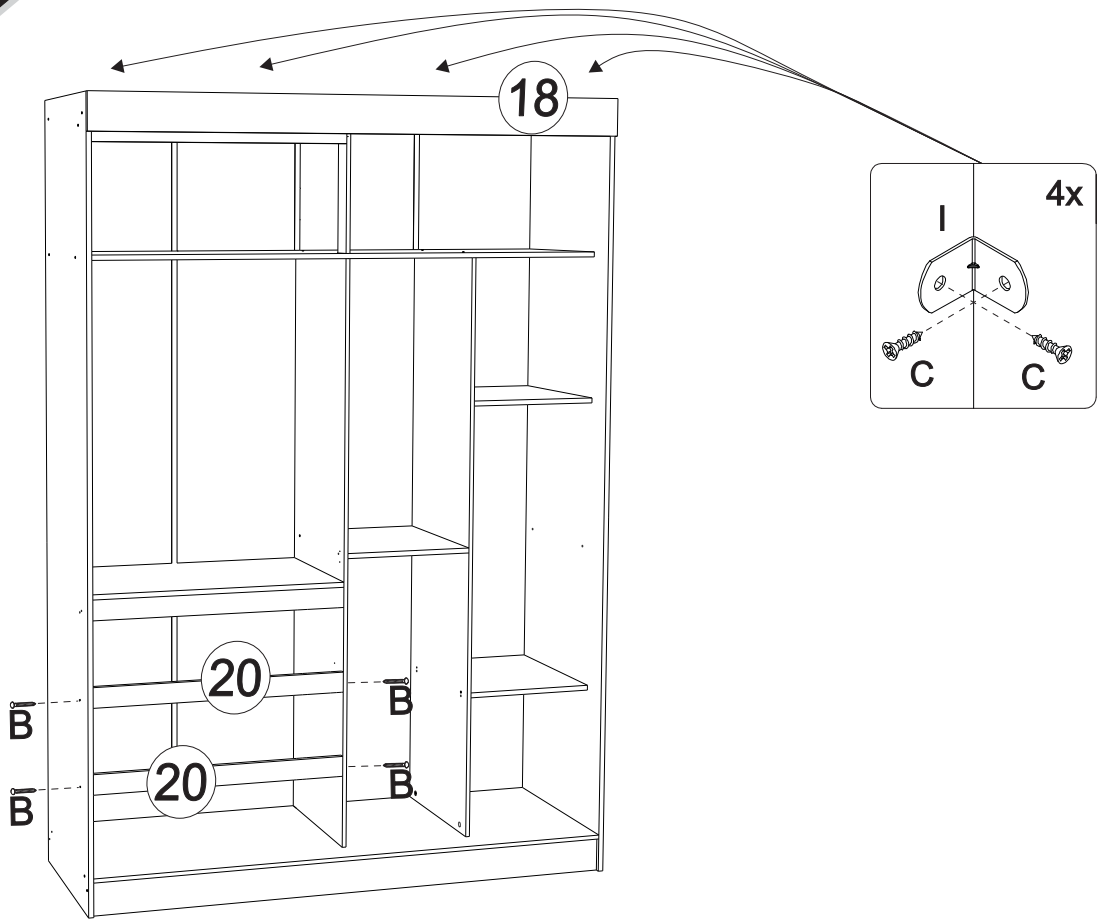

# 08 Montagem/Montaje

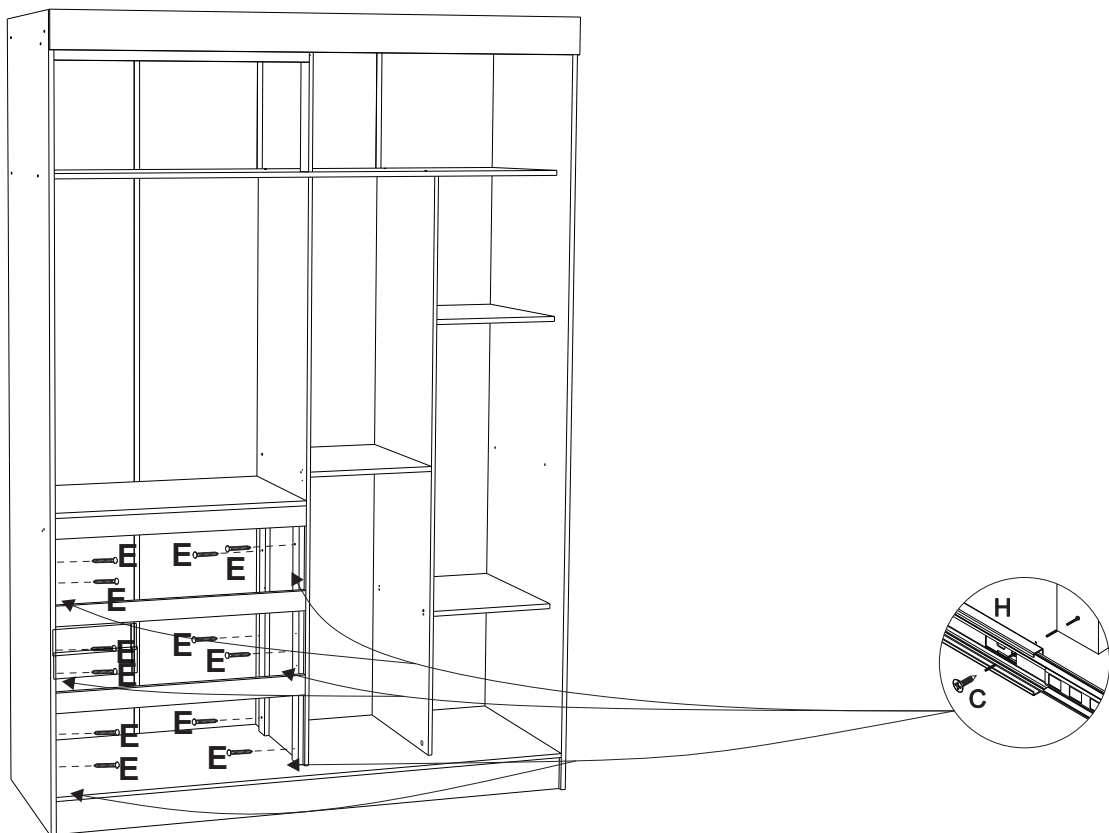

## 08 Montagem/Montaje

(3x)

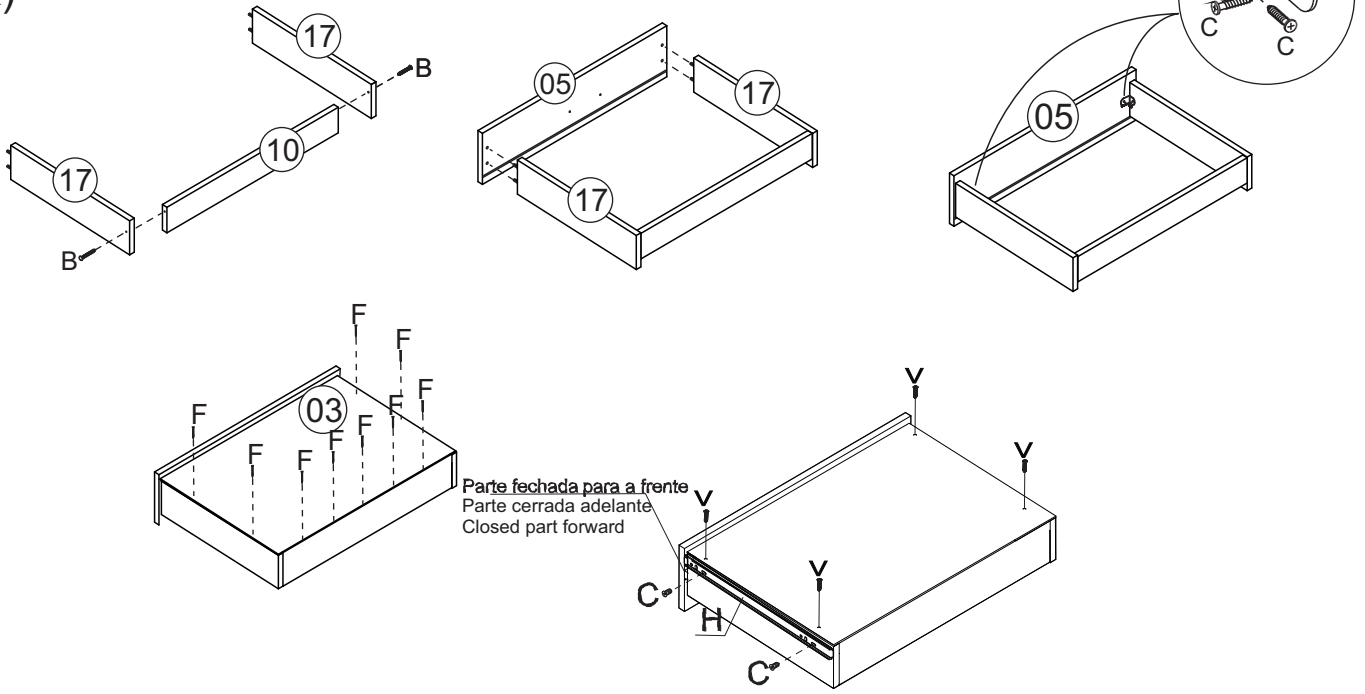

## 09 Montagem/Montaje

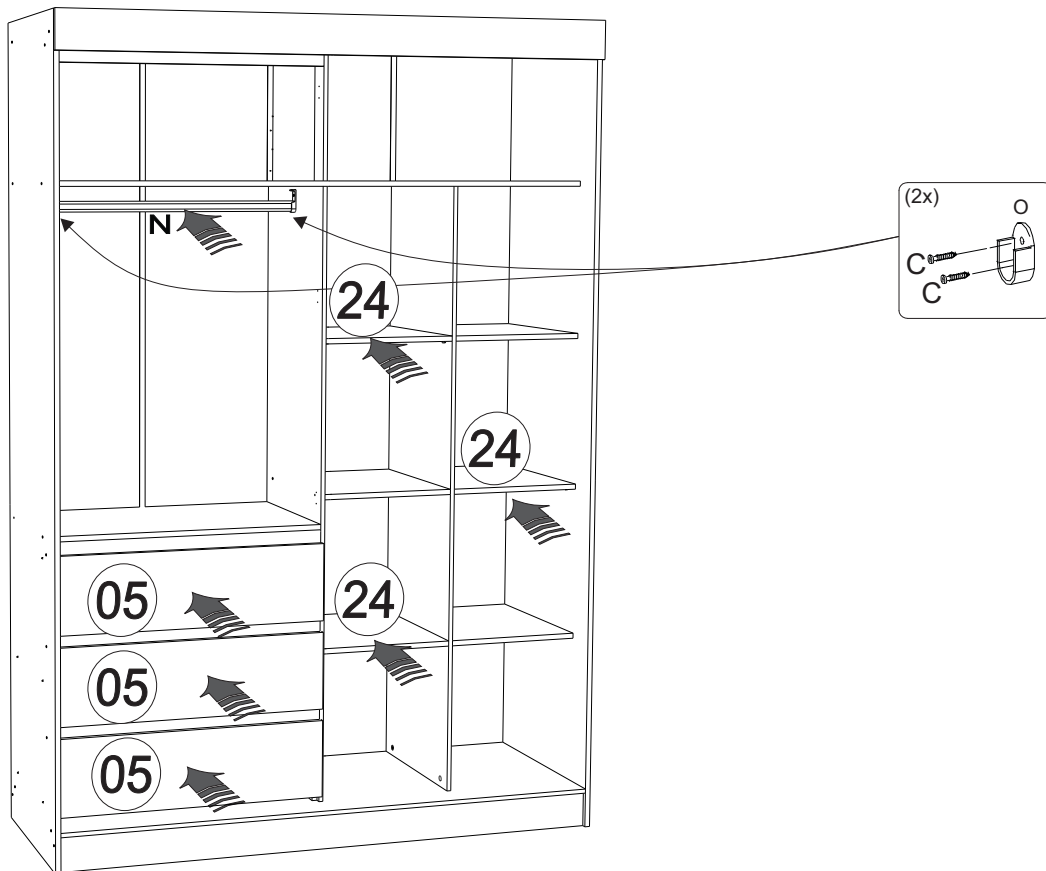



# 10 → Montagem/Montaje

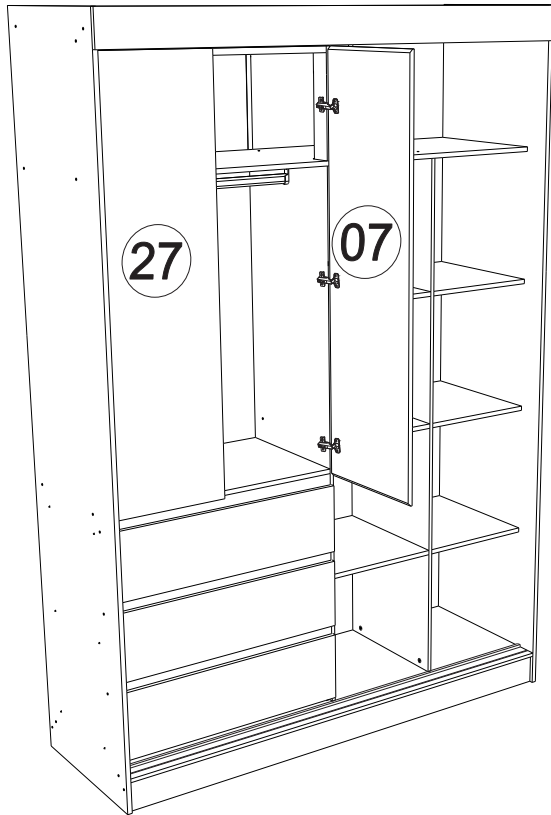

# 11 → Montagem/Montaje

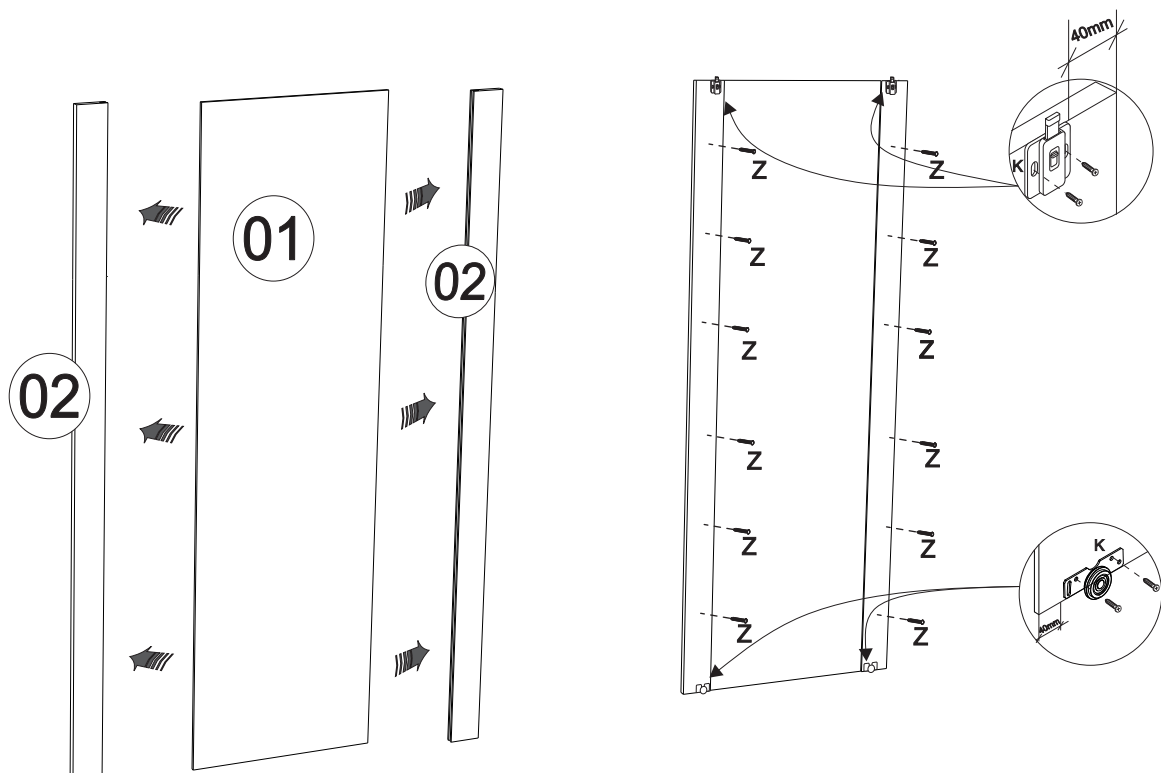

# 12 Montagem/Montaje

\*Encaixar as portas primeiro no trilho superior e depois no trilho inferior.

Encajar primero las puertas en el trillo superior y después en el trillo inferior.

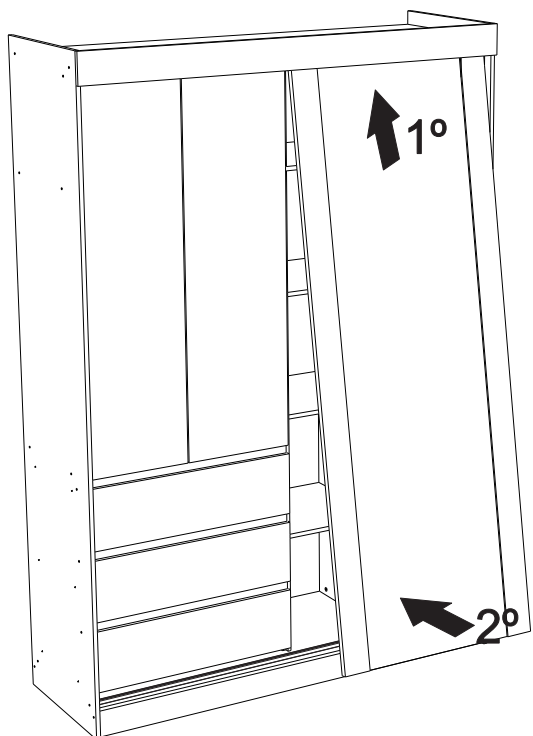

	Produto para ser aplicado em caso de riscos na superfície.
	Product to be applied in case of scratches on the surface.
	Producto para ser aplicado en caso de rayas en la superficie.

		2:00		