

Classic Home

Roupeiro / Armário / Wardrobe

BERLIM

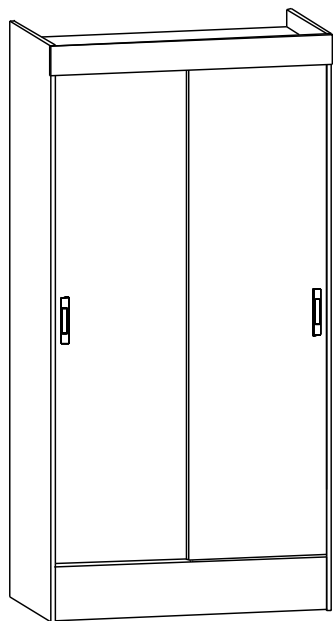

MANUAL DE MONTAGEM INSTRUCCIONES DE ARMADO ASSEMBLY INSTRUCTIONS

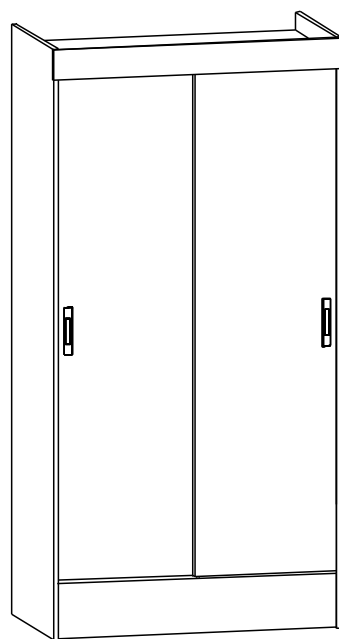
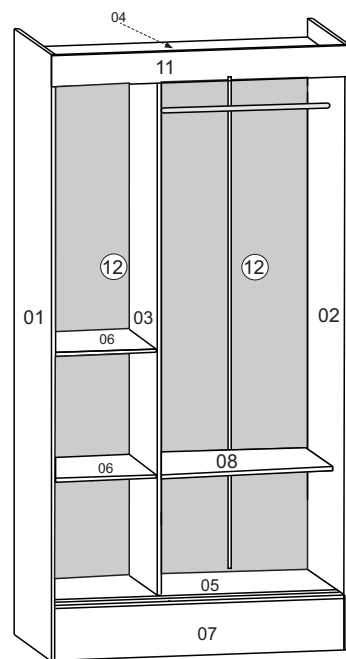
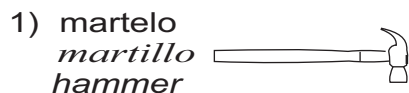

POR

ESD











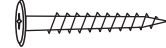



END

- 01 - Lateral esquerda
- 02 - Lateral direita
- 03 - Divisória
- 04 - Tampo superior
- 05 - Tampo inferior
- 06 - Prateleiras (2x)
- 07 - Rodapé Frontal
- 08 - Chapéu
- 10 - Porta (2x)
- 11 - Frontal
- 12 - Costas (3x)

- 01 - Lateral izquierda
- 02 - Lateral derecha
- 03 - Divisoria
- 04 - Tapa superior
- 05 - Tapa inferior
- 06 - Estantes (2x)
- 07 - Zócalo Frontal
- 08 - Estante
- 10 - Puerta (2x)
- 11 - Frontal
- 12 - Dorso (3x)

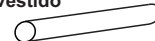
- 01 - Lateral esquerda
- 02 - Lateral direita
- 03 - Divisória
- 04 - Upper top
- 05 - Tampo inferior
- 06 - Shelf (2x)
- 07 - Rodapé Frontal
- 08 - Top
- 10 - Door (2x)
- 11 - Front
- 12 - Back (3x)

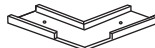
Ferragens/Herraje/Hardware:

Cód	Itens	Quan
A	Cavilhas 6 x 30 Clavija Bowel 	04
B	Parafuso 3,5 x 40 c/F Tornillo Screw 	18
C	Porca cilíndrica Tuerca cilíndrica Cylindrical nut 	12
D	Kit portas de correr c/ parafusos Kit puertas corrediza c/tornillo Sliding door kit 	01
E	Pino Suporte Soporte Support 	08
F	Taxa 10 x 10 Clavo 10 x10 Nail 10 x 10 	60
G	Parafuso 3,5 x 12 c/c Tornillo Screw 	14
I	Cantoneira Esquinera Cantoneira 	03
J	Suporte de Cabide Apoyo de percha Hanger support 	02
K	Parafuso 3,5 x 14 c/ flangeado Tornillo Screw 	04
L	Puxador Lages 128MM Tirador Handle 	02
M	Sapata U 15 mm Pata Feet 	02
O	Cabideiro de madeira revestido Holding 	01
P	Trilho guia plástico 895 mm 	02
R	Trilho guia inferior alumínio 895 mm 	01
S	Sapata L Pata Feet 	02
T	Tapa furo Tapa Top 	08

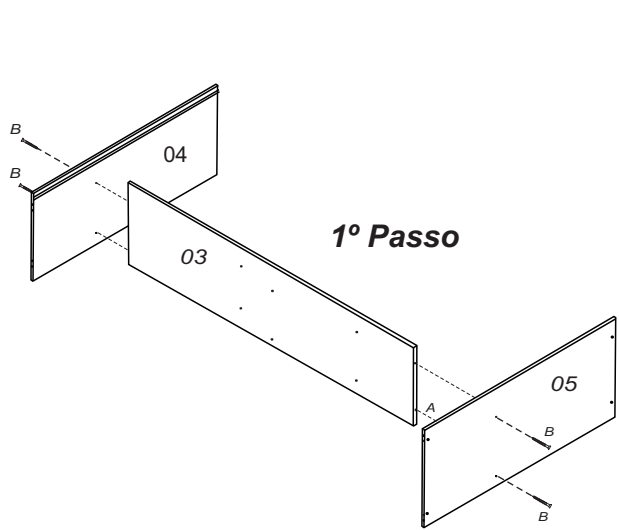

1º Passo

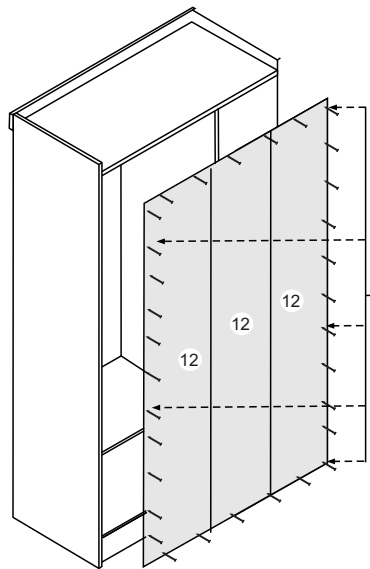

3º Passo

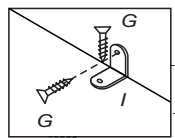
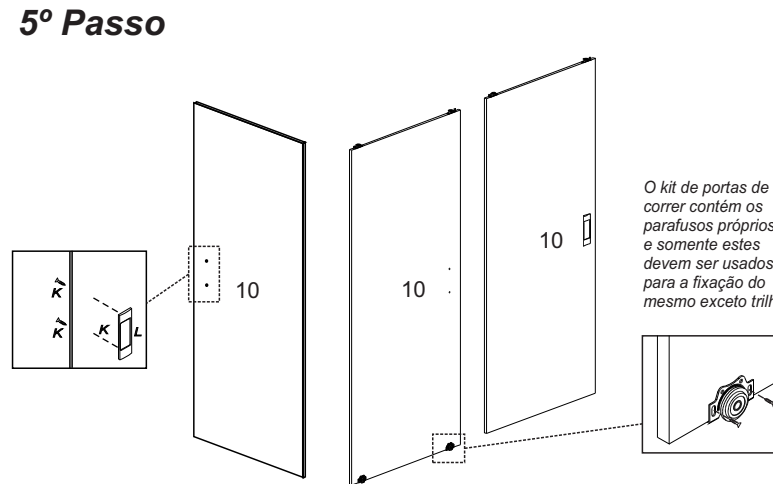

2º Passo

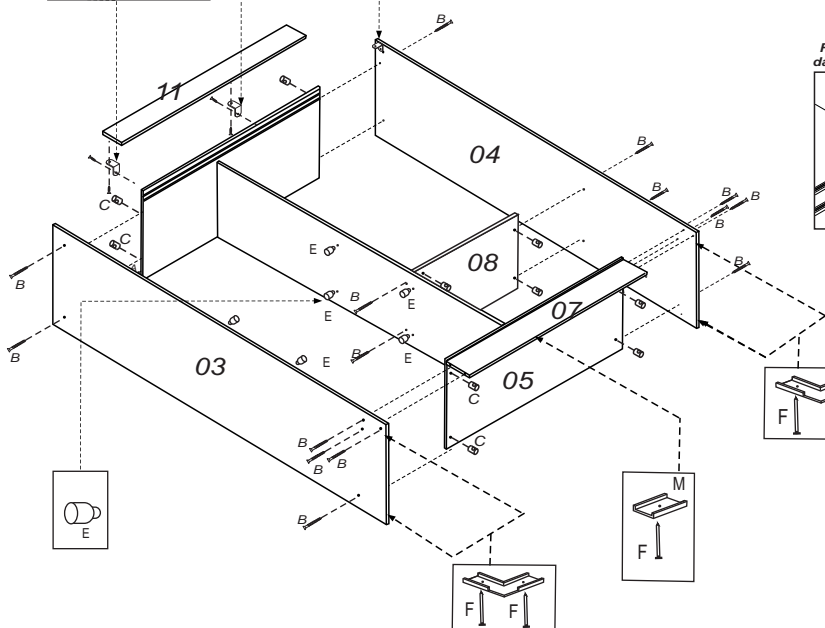

4º Passo

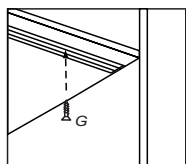

Fixar o trilho (X) a 30mm da parte interna do frontal.

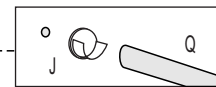
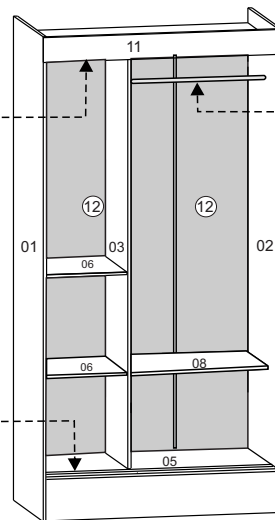
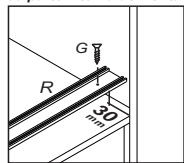

6º Passo

Introduza a porta no trilho superior, em seguida alinhe com o trilho inferior e aloque o rodízio em seu espaço.

