

MANUAL DE MONTAGEM / ASSEMBLY INSTRUCTIONS / PLANO DE ARMADO

Antes de montar o móvel, leia com atenção o manual de montagem!
Before assembling the furniture, carefully read the assembly instructions!
Antes de armar el mueble, lea con atención el manual de ensamble!

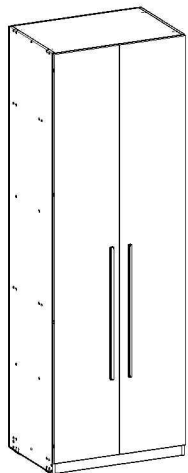

Ref.: 2054

genialflex
ambientes incríveis para todos

Parabéns! Você comprou um produto de excelente qualidade, fabricado com chapa de madeira de MDP ou MDF, extraída de florestas renováveis. Possui alta resistência e design atual.

Congratulations! You have purchased a product of excellent quality, made from MDP or MDF wood veneer, extracted from renewable forests. It has high strength and current design.

Felicitaciones! Usted compró a un producto de excelente calidad, fabricado con placa de madera de MDP o MDF, proveniente de florestas renovables. Tiene alta resistencia y diseño actual.



ATENÇÃO
ATTENTION
ATENCIÓN

- 1)** Verifique todas as peças antes de começar a montagem.
Check all parts before starting assembly.
Verifique todas las partes antes de empezar el armado.
- 2)** Ao começar a montagem, não apoie as peças na parede.
When starting the assembly, do not support the parts on the wall.
Al empezar el armado, no apoyes las partes en la pared.
- 3)** Ao colocar as peças e ferragens de lado, cuidado para não perde-las.
When placing parts and hardware aside, be careful not to lose them.
Al poner las piezas y herrages a parte, cuidado para no dañarlas.
- 4)** O móvel deve ser montado no chão, para isso, use a própria caixa para proteger e não danificar o piso.
The furniture must be mounted on the floor, to do this, use the box itself to protect and not damage the floor.
El mueble suele ser armado al piso, para eso, use la propia caja para protegerlo y no dañar al piso.

- 5)** Comece a montagem seguindo as instruções passo a passo.
Begin assembly by following the step-by-step instructions.
Comience el armado siguiendo la instrucciones paso a paso.
- 6)** É de responsabilidade do montador seguir as intruções desse manual, que são fundamentais para a estrutura do móvel.
It's the assembler's responsibility to follow the instructions in this manual, which are fundamental to the structure of the furniture.
Es de responsabilidad del armador seguir las instrucciones de este manual, que son fundamentales para la estructura del mueble.

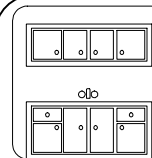

CUIDADOS
CARE
CUIDADO

- 1)** A conservação e limpeza deve ser feita com um pano levemente umedecido com água.
Care and cleaning should be done with a cloth slightly moistened with water.
La conservación y limpieza debe ser hecha con un trapo levemente humedecido en agua.
- 2)** Não use produtos abrasivos, como saponáceo, detergentes e esponja de aço.
Do not use abrasive products, such as soap, detergents and steel sponge.
No use productos abrasivos, como saponáceo, detergentes y esponja de acero.
- 3)** Não use cera ou óleo para dar brilho ao móvel.
Do not use wax or oil to shine the furniture.
No use cera o aceites para darle brillo al mueble.
- 4)** Não expor o móvel a interpéries e nem ao calor excessivo.
Do not expose the furniture to weather or excessive heat.
No exponer el mueble a interperies ni al calor excesivo.
- 5)** Ao terminar a montagem, limpe o ambiente e o móvel.
When the assembly is finished, clean the room and the furniture.
Al terminar el armado, limpie al ambiente y al mueble.

FERRAMENTAS / TOOLS / HERRAMIENTAS



MARTELO
HAMMER
MARTILLO



MARTELO DE BORRACHA
RUBBER HAMMER
MARTILLO GOMA



CHAVE PHILLIPS
PHILLIPS SCREWDRIVER
LLAVE PHILLIPS



TRENA
MEASURING TAPE
CINTA MÉTRICA









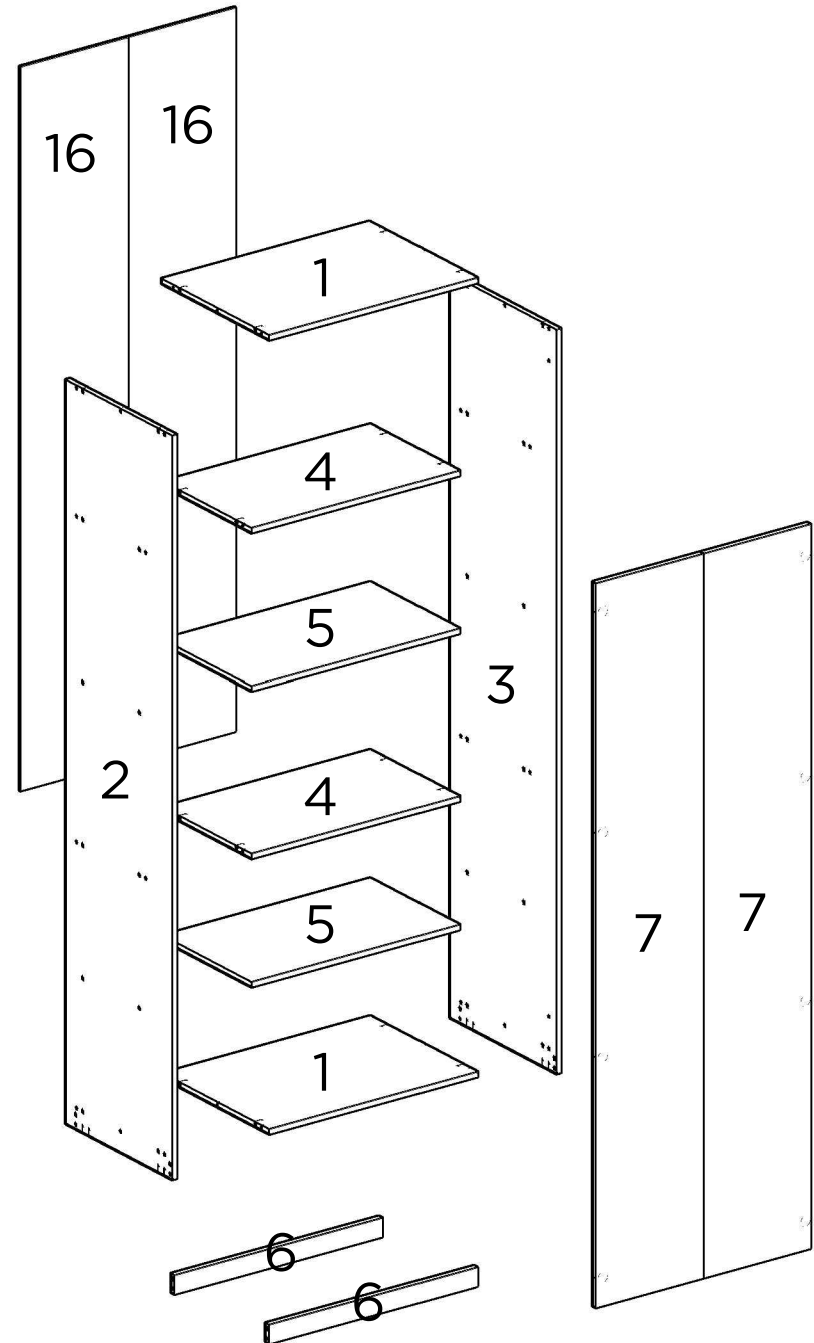



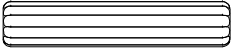

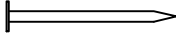

PARAFUSADEIRA
DRILL/ELETRIC
SCREWDRIVER
DESTORNILLADOR
ELÉCTRICO

PEÇAS / PARTS / PIEZAS

Nº No Num	DESCRIÇÃO DESCRIPTION DESCRIPCIÓN	QTD QTY CANT
1	BASE/TAMPO BOTTOM/TOP BASE/TABLERO	2
2	LATERAL ESQUERDA LEFT SIDE PANEL LATERAL IZQUIERDA	1
3	LATERAL DIREITA RIGHT SIDE PANEL LATERAL DERECHA	1
4	PRATELEIRA FIXA FIXED PLATE PANEL REPISA FIJO	2
5	PRATELEIRA PLATE PANEL REPISA	2
6	RODAPÉ BASEBOARD ZÓCALO	2
7	PORTA DOOR PUERTA	2
16	COSTA BACK PANEL TRASERO	2

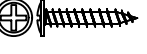
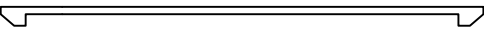

FERRAGENS / HARDWARE / HERRAJES

CÓD CODE COD	DESCRIÇÃO DESCRIPTION DESCRIPCIÓN	QTD QTY CANT
A	 CAVILHA WOODEN DOWEL TARUGO	20
B	 SUPORTE DE PRATELEIRA SHELF SUPPORT SOPORTE DE ESTANTES	8
C	 SAPATA PLÁSTICA PLASTIC SHOE ZAPATA PLASTICA	4
D	 PARAFUSO 3,5X40mm SCREW 3,5X40mm TORNILLO 3,5X40mm	24
E	 PREGO NAIL CLAVO	42
F	 PERFIL I PROFILE I PERFIL I	1
G	 PARAFUSO 4X14mm SCREW 4X14mm TORNILLO 4X14mm	34
H	 SUPORTE DE FIXAÇÃO MOUNTING SUPPORT SOPORTE DE MONTAJE	1
I	 BUCHA PLÁSTICA PLASTIC BUSHING CASQUILLO PLÁSTICO	1
J	 PARAFUSO 5X50mm SCREW 5X50mm TORNILLO 5X50mm	1
K	 DOBRADIÇA HINGE BIZAGRA	8
L	 CALÇO PARA DOBRADIÇA HINGE SHED CALZO DE BISAGRA	8
M	 PARAFUSO 3,5X25mm SCREW 3,5X25mm TORNILLO 3,5X25mm	16
N	 PUXADOR PULLER TIRADOR	2
O	 PARAFUSO 3.5X25mm SCREW 3.5X25mm TORNILLO 3.5X25mm	5

UTILIZE A RÉGUA PARA IDENTIFICAR OS PARAFUSOS
USE THE RULER TO IDENTIFY THE SCREWS
UTILICE LA REGLA PARA IDENTIFICAR LOS TORNILLOS

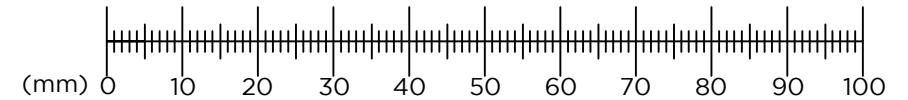

PESO SUPORTADO / WEIGHT SUPPORTED / PESO SOPORTADO

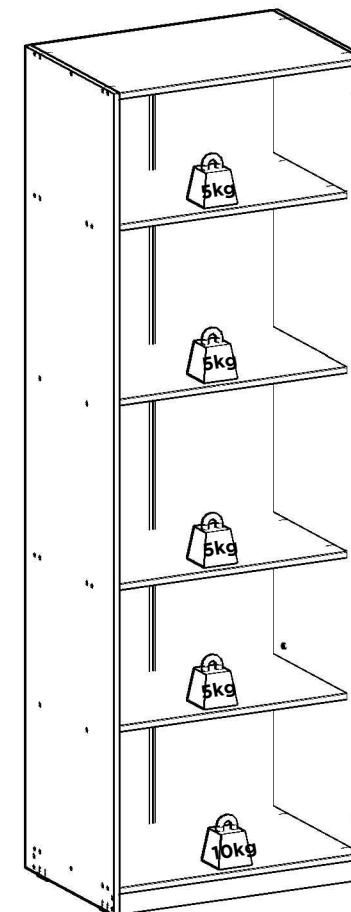

7

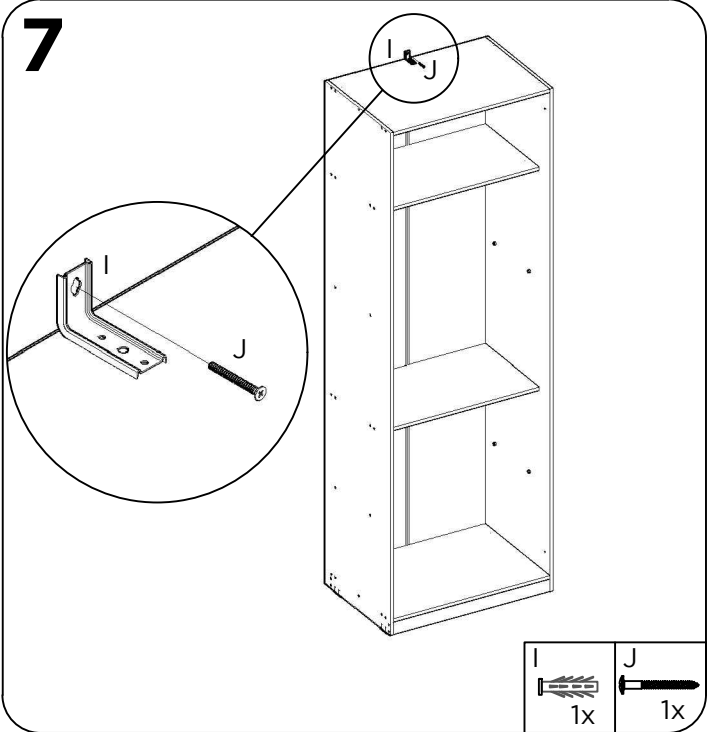

USE A BUCHA DE ACORDO COM O MATERIAL DA PAREDE
 USE LA BUJE DE ACUERDO CON EL MATERIAL DE LA PARED
 USE THE BUSHING ACCORDING TO THE WALL MATERIAL

MATERIAL DA PAREDE: Painel de gesso ou estuque com viga de madeira;
SISTEMA DE FIXAÇÃO: Parafuso de fixação inserido diretamente na viga de madeira.

WALL MATERIAL: Plaster or stucco panel with wooden beam;
FIXING SYSTEM: Fixing screw inserted directly into the wooden beam.

MATERIAL DE LA PARED: Panel de yeso o estuco con viga de madera;
SISTEMA DE FIJACIÓN: Tornillo de fijación insertado directamente en la viga de madera.

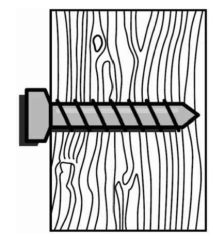

MATERIAL DA PAREDE: Painel de gesso sem viga de madeira;
SISTEMA DE FIXAÇÃO: Parafuso de fixação com bucha plástica.

WALL MATERIAL: Plaster panel without wooden beam;
FIXING SYSTEM: Fixing screw with plastic bushing.

MATERIAL DE LA PARED: Panel de yeso sin viga de madera;
SISTEMA DE FIJACIÓN: Tornillo de fijación con buje de plástico.

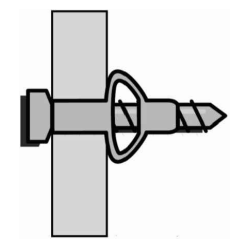

MATERIAL DA PAREDE: Alvenaria (concreto ou tijolo);
SISTEMA DE FIXAÇÃO: Parafuso de fixação com bucha.

WALL MATERIAL: Masonry (concrete or brick);
FIXING SYSTEM: Fixing screw with plastic bushing.

MATERIAL DE LA PARED: Albañilería (hormigón o ladrillo);
SISTEMA DE FIJACIÓN: Tornillo de fijación con buje de plástico.

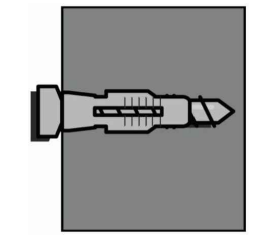

8

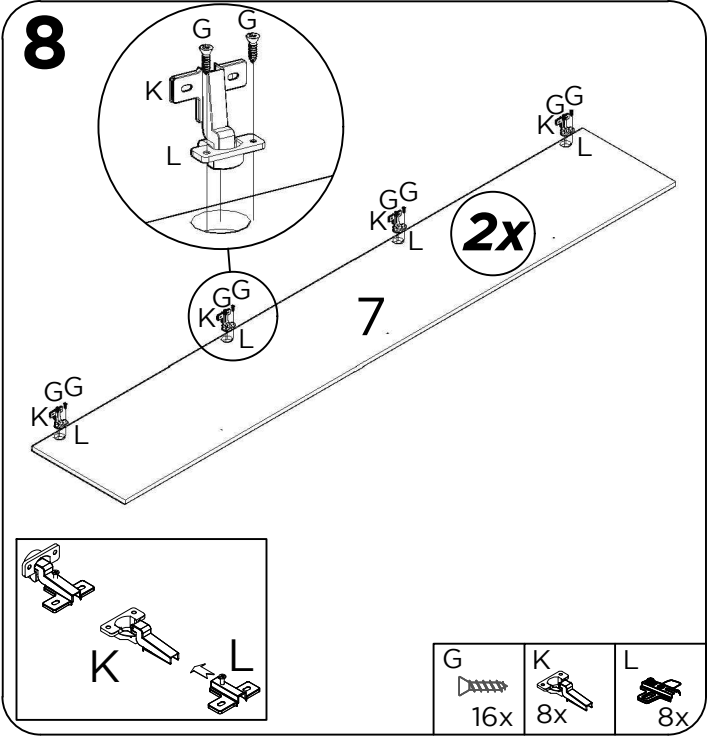

9

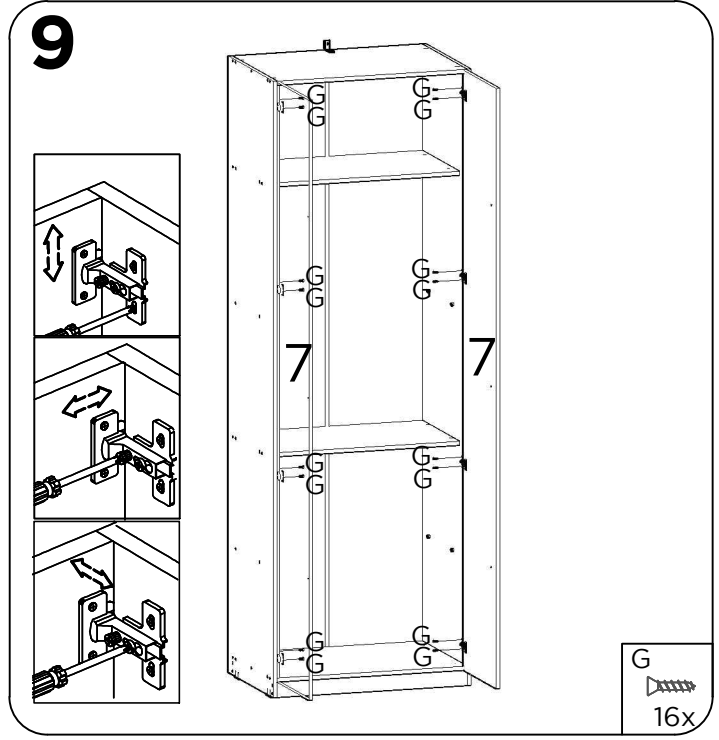

10

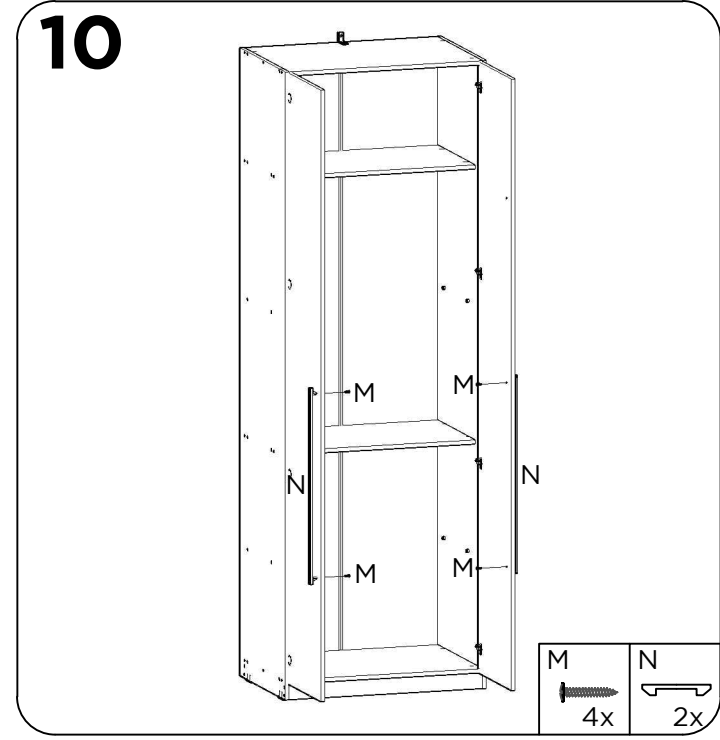

11

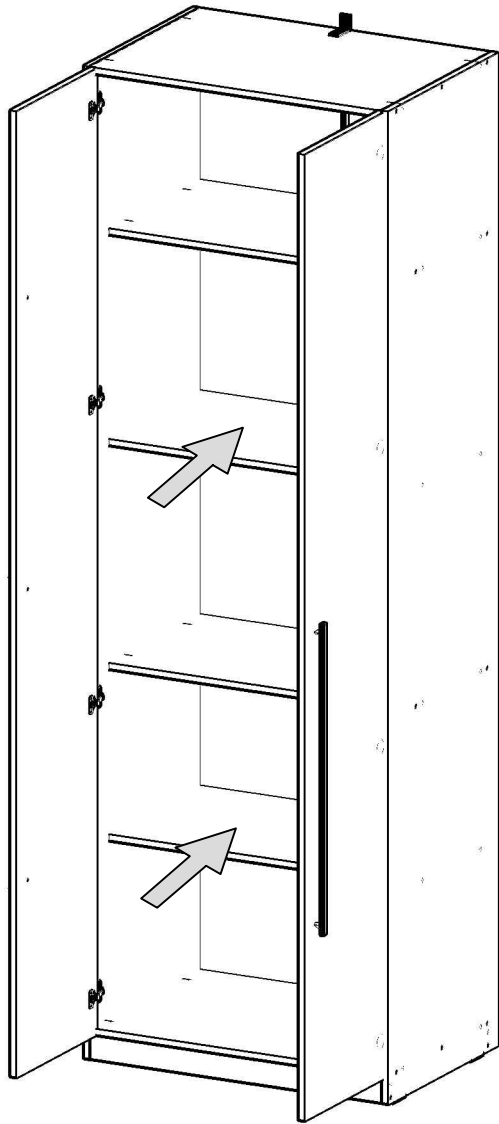

12

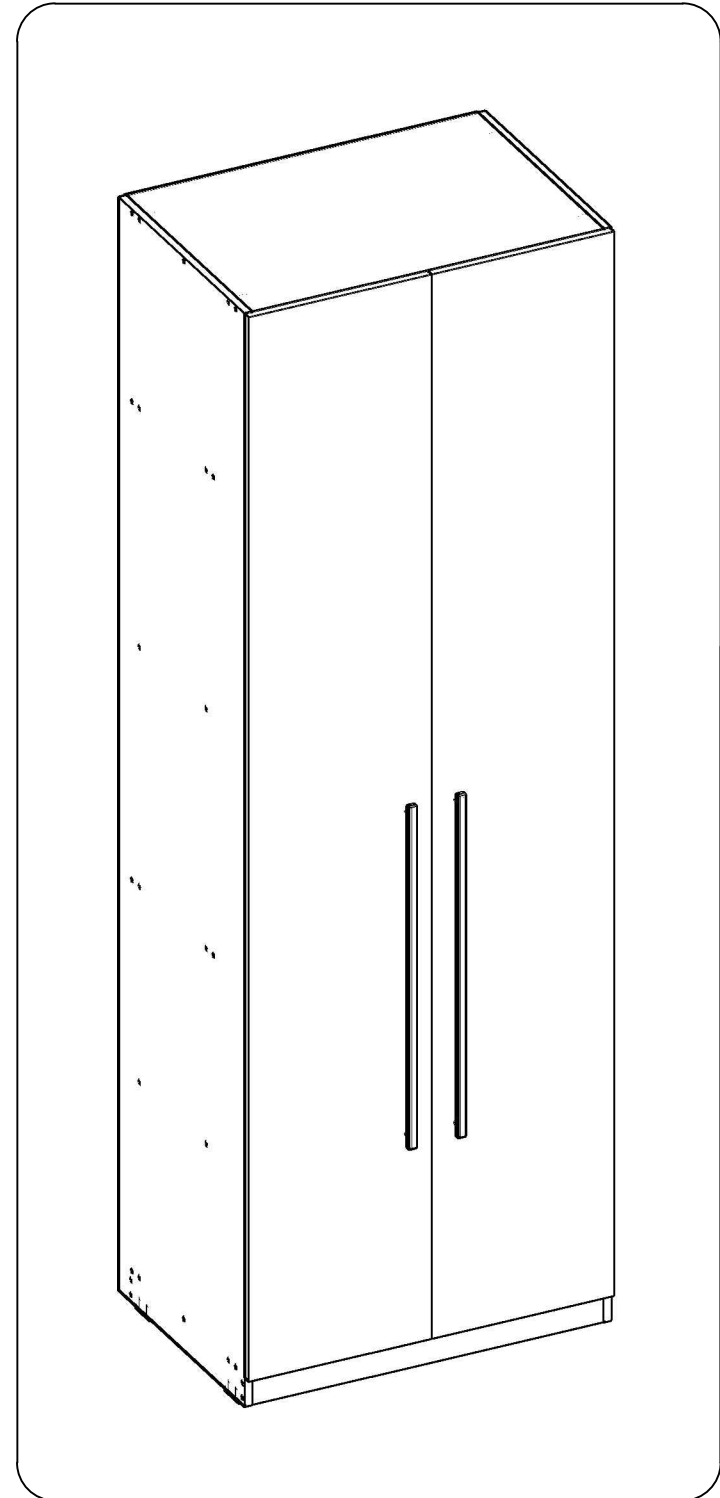
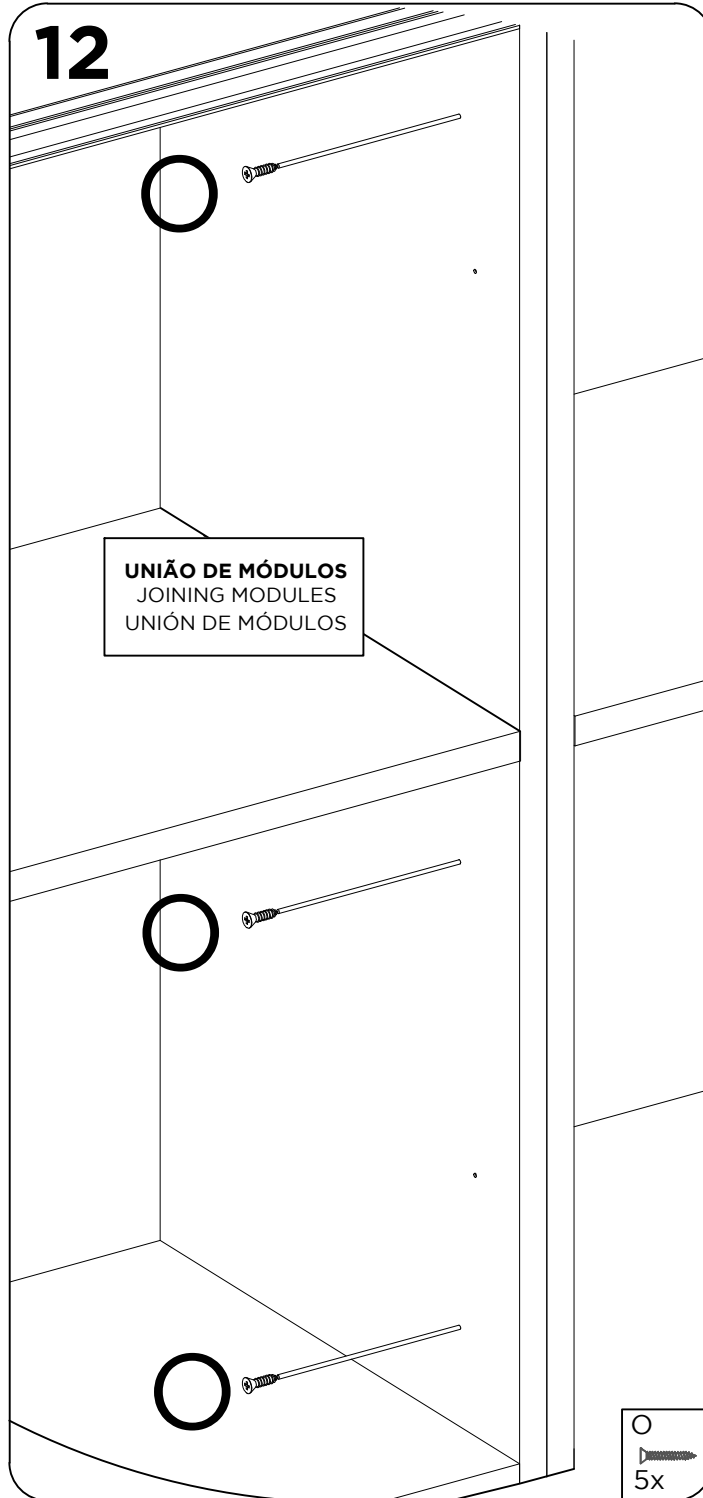

MANUAL DE MONTAGEM / ASSEMBLY INSTRUCTIONS / PLANO DE ARMADO

Antes de montar o móvel, leia com atenção o manual de montagem!
Before assembling the furniture, carefully read the assembly instructions!
Antes de armar el mueble, lea con atención el manual de ensamble!

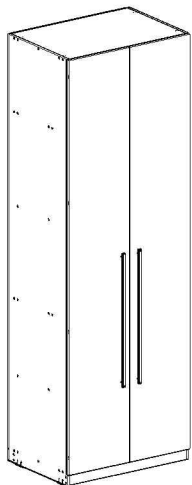

Ref.: 2056

genialflex
ambientes incríveis para todos

Parabéns! Você comprou um produto de excelente qualidade, fabricado com chapa de madeira de MDP ou MDF, extraída de florestas renováveis. Possui alta resistência e design atual.

Congratulations! You have purchased a product of excellent quality, made from MDP or MDF wood veneer, extracted from renewable forests. It has high strength and current design.

Felicitaciones! Usted compró a un producto de excelente calidad, fabricado con placa de madera de MDP o MDF, proveniente de florestas renovables. Tiene alta resistencia y diseño actual.



ATENÇÃO
ATTENTION
ATENCIÓN

- 1)** Verifique todas as peças antes de começar a montagem.
Check all parts before starting assembly.
Verifique todas las partes antes de empezar el armado.
- 2)** Ao começar a montagem, não apoie as peças na parede.
When starting the assembly, do not support the parts on the wall.
Al empezar el armado, no apoyes las partes en la pared.
- 3)** Ao colocar as peças e ferragens de lado, cuidado para não perde-las.
When placing parts and hardware aside, be careful not to lose them.
Al poner las piezas y herrages a parte, cuidado para no dañarlas.
- 4)** O móvel deve ser montado no chão, para isso, use a própria caixa para proteger e não danificar o piso.
The furniture must be mounted on the floor, to do this, use the box itself to protect and not damage the floor.
El mueble suele ser armado al piso, para eso, use la propia caja para protegerlo y no dañar al piso.

- 5)** Comece a montagem seguindo as instruções passo a passo.
Begin assembly by following the step-by-step instructions.
Comience el armado siguiendo la instrucciones paso a paso.
- 6)** É de responsabilidade do montador seguir as intruções desse manual, que são fundamentais para a estrutura do móvel.
It's the assembler's responsibility to follow the instructions in this manual, which are fundamental to the structure of the furniture.
Es de responsabilidad del armador seguir las instrucciones de este manual, que son fundamentales para la estructura del mueble.

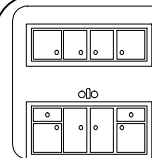

CUIDADOS
CARE
CUIDADO

- 1)** A conservação e limpeza deve ser feita com um pano levemente umedecido com água.
Care and cleaning should be done with a cloth slightly moistened with water.
La conservación y limpieza debe ser hecha con un trapo levemente humedecido en agua.
- 2)** Não use produtos abrasivos, como saponáceo, detergentes e esponja de aço.
Do not use abrasive products, such as soap, detergents and steel sponge.
No use productos abrasivos, como saponáceo, detergentes y esponja de acero.
- 3)** Não use cera ou óleo para dar brilho ao móvel.
Do not use wax or oil to shine the furniture.
No use cera o aceites para darle brillo al mueble.
- 4)** Não expor o móvel a interpéries e nem ao calor excessivo.
Do not expose the furniture to weather or excessive heat.
No exponer el mueble a interperies ni al calor excesivo.
- 5)** Ao terminar a montagem, limpe o ambiente e o móvel.
When the assembly is finished, clean the room and the furniture.
Al terminar el armado, limpie al ambiente y al mueble.

FERRAMENTAS / TOOLS / HERRAMIENTAS



MARTELO
HAMMER
MARTILLO



MARTELO DE BORRACHA
RUBBER HAMMER
MARTILLO GOMA

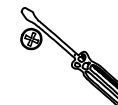

CHAVE PHILLIPS
PHILLIPS SCREWDRIVER
LLAVE PHILLIPS



TRENA
MEASURING TAPE
CINTA MÉTRICA









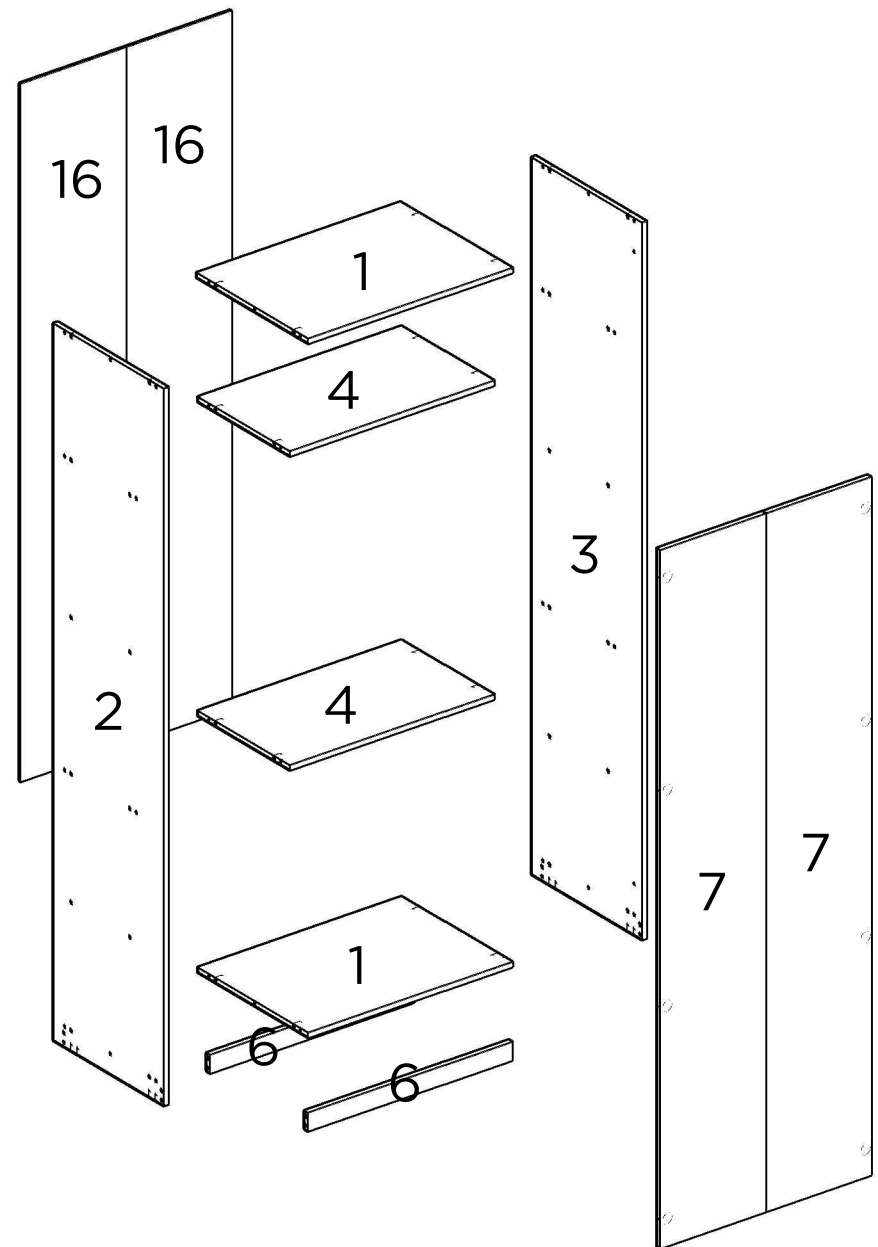



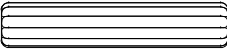

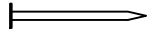

PARAFUSADEIRA
DRILL/ELETRIC
SCREWDRIVER
DESTORNILLADOR
ELÉCTRICO

PEÇAS / PARTS / PIEZAS

Nº No Num	DESCRIÇÃO DESCRIPTION DESCRIPCIÓN	QTD QTY CANT
1	BASE/TAMPO BOTTOM/TOP BASE/TABLERO	2
2	LATERAL ESQUERDA LEFT SIDE PANEL LATERAL IZQUIERDA	1
3	LATERAL DIREITA RIGHT SIDE PANEL LATERAL DERECHA	1
4	PRATELEIRA CABIDEIRO CABINET PLATE PANEL REPIZA GABINETE	2
6	RODAPÉ BASEBOARD ZÓCALO	2
7	PORTA DOOR PUERTA	2
16	COSTA BACK PANEL TRASERO	2

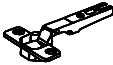

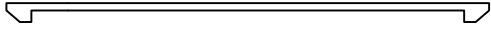
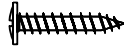
FERRAGENS / HARDWARE / HERRAJES

CÓD CODE COD	DESCRIÇÃO DESCRIPTION DESCRIPCIÓN	QTD QTY CANT
A	 CAVILHA WOODEN DOWEL TARUGO	20
B	 SAPATA PLÁSTICA PLASTIC SHOE ZAPATA PLASTICA	4
C	 PARAFUSO 3,5X40mm SCREW 3,5X40mm TORNILLO 3,5X40mm	24
D	 PREGO NAIL CLAVO	42
E	 PERFIL I PROFILE I PERFIL I	1
F	 PARAFUSO 4X14mm SCREW 4X14mm TORNILLO 4X14mm	42
G	 SUPORTE DE FIXAÇÃO MOUNTING SUPPORT SOPORTE DE MONTAJE	1
H	 PARAFUSO 5X50mm SCREW 5X50mm TORNILLO 5X50mm	1
I	 BUCHA PLÁSTICA PLASTIC BUSHING CASQUILLO PLÁSTICO	1
J	 SUPORTE DE CABIDEIRO HANGER SUPPORT SUPORTE PARA PERCHAS	4
K	 TAPA-FURO COM RANHURA HOLE COVER TAPA AGUJERO	8
L	 DOBRADIÇA HINGE BIZAGRA	8
M	 CALÇO PARA DOBRADIÇA HINGE SHED CALZO DE BISAGRA	8
N	 PUXADOR PULLER TIRADOR	2
O	 PARAFUSO 3,5X25mm SCREW 3,5X25mm TORNILLO 3,5X25mm	4
P	 PARAFUSO 3,5X25mm SCREW 3,5X25mm TORNILLO 3,5X25mm	5

UTILIZE A RÉGUA PARA IDENTIFICAR OS PARAFUSOS
USE THE RULER TO IDENTIFY THE SCREWS
UTILICE LA REGLA PARA IDENTIFICAR LOS TORNILLOS

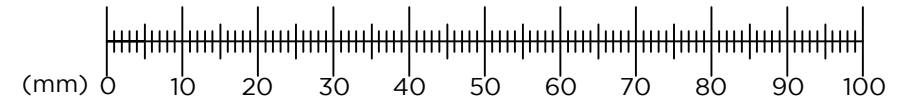

PESO SUPORTADO / WEIGHT SUPPORTED / PESO SOPORTADO

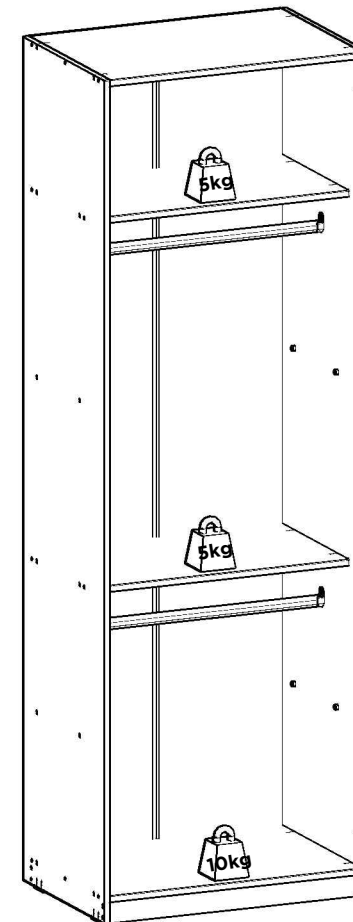

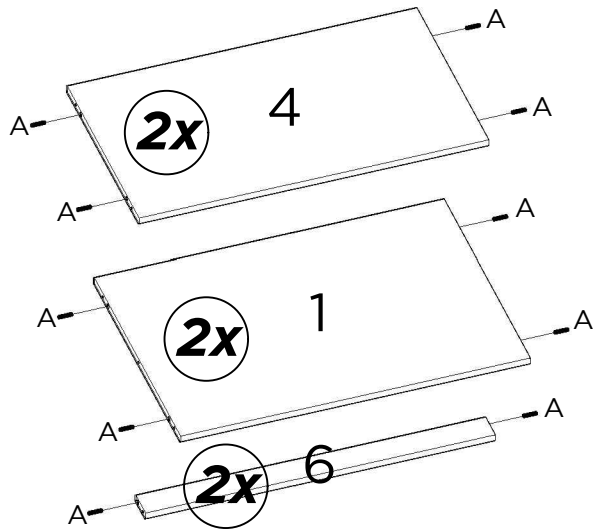
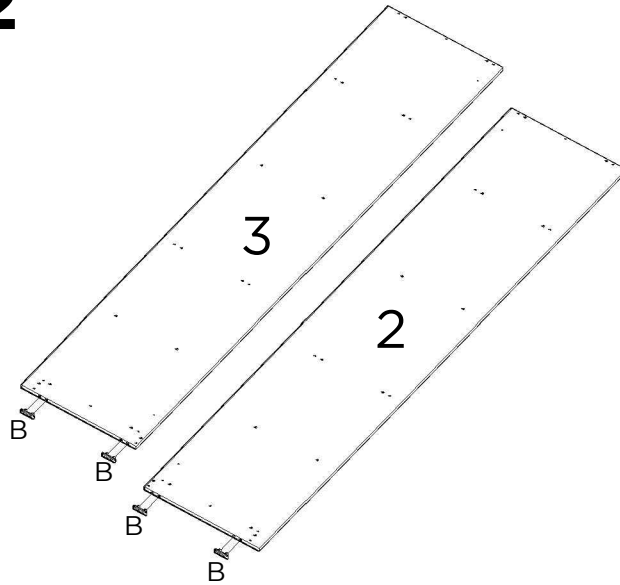
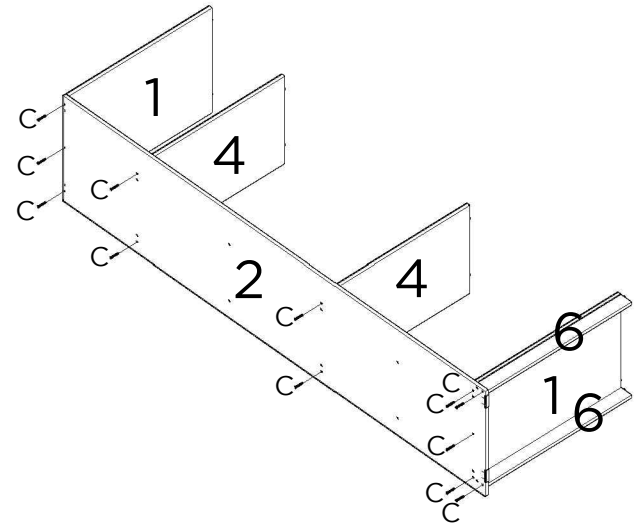
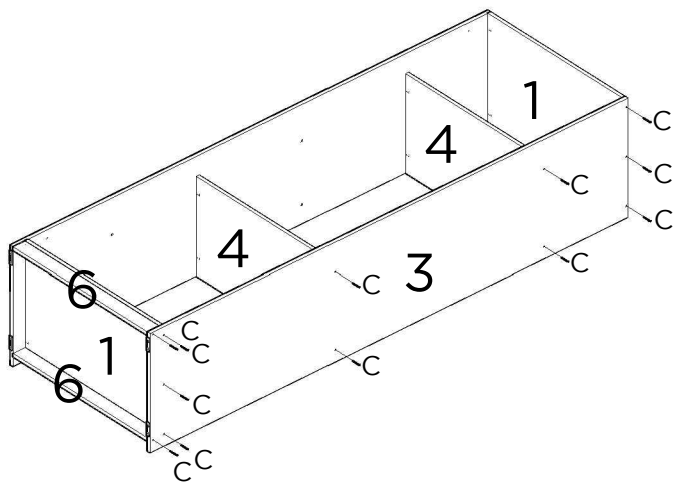
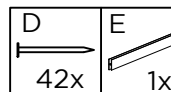
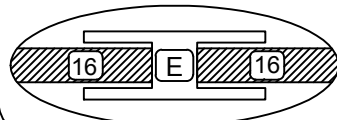
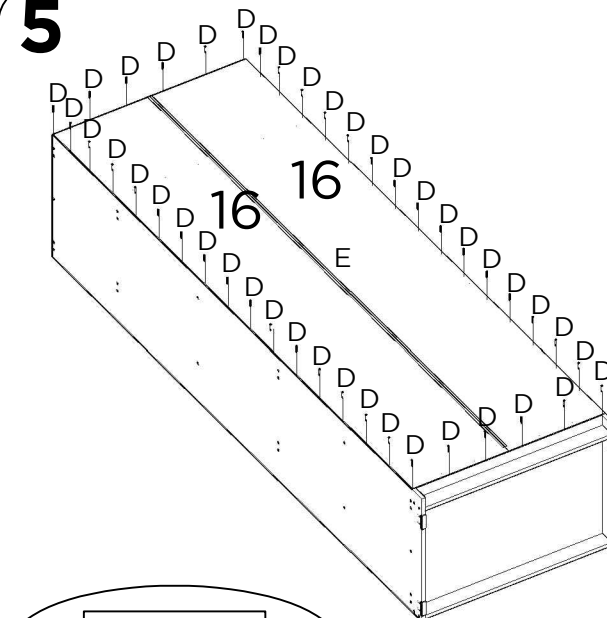
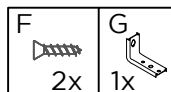
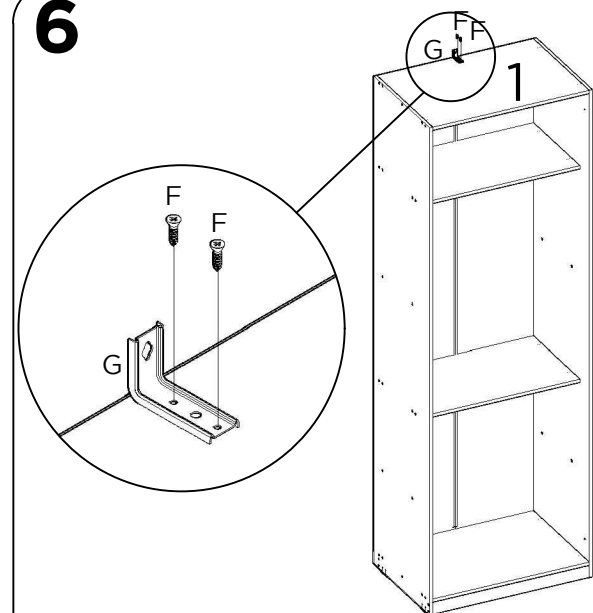
1**2****3****4****5****6**

7

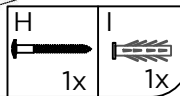
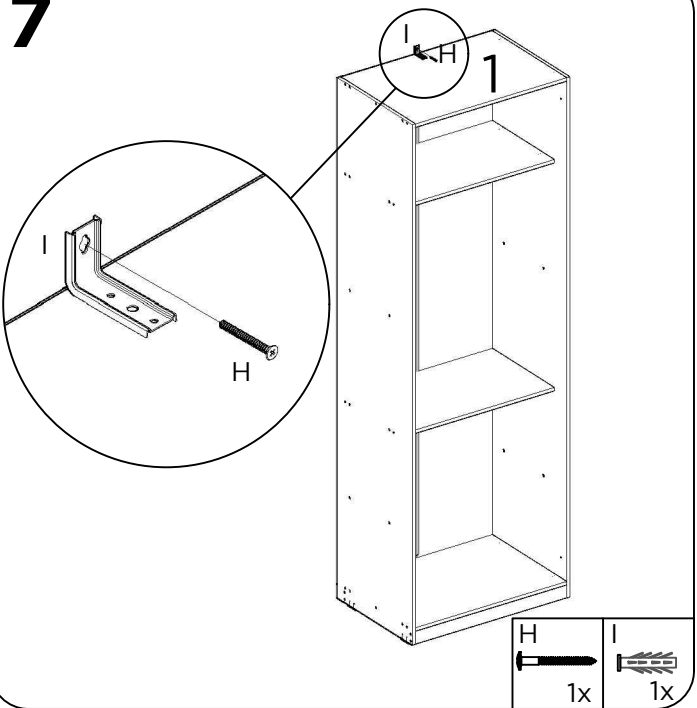

USE A BUCHA DE ACORDO COM O MATERIAL DA PAREDE
 USE LA BUJE DE ACUERDO CON EL MATERIAL DE LA PARED
 USE THE BUSHING ACCORDING TO THE WALL MATERIAL

MATERIAL DA PAREDE: Painel de gesso ou estuque com viga de madeira;
SISTEMA DE FIXAÇÃO: Parafuso de fixação inserido diretamente na viga de madeira.

WALL MATERIAL: Plaster or stucco panel with wooden beam;
FIXING SYSTEM: Fixing screw inserted directly into the wooden beam.

MATERIAL DE LA PARED: Panel de yeso o estuco con viga de madera;
SISTEMA DE FIJACIÓN: Tornillo de fijación insertado directamente en la viga de madera.

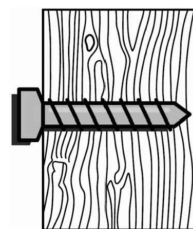

MATERIAL DA PAREDE: Painel de gesso sem viga de madeira;
SISTEMA DE FIXAÇÃO: Parafuso de fixação com bucha plástica.

WALL MATERIAL: Plaster panel without wooden beam;
FIXING SYSTEM: Fixing screw with plastic bushing.

MATERIAL DE LA PARED: Panel de yeso sin viga de madera;
SISTEMA DE FIJACIÓN: Tornillo de fijación con buje de plástico.

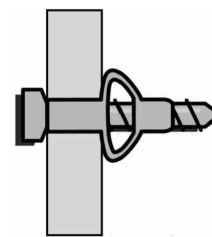

MATERIAL DA PAREDE: Alvenaria (concreto ou tijolo);
SISTEMA DE FIXAÇÃO: Parafuso de fixação com bucha.

WALL MATERIAL: Masonry (concrete or brick);
FIXING SYSTEM: Fixing screw with plastic bushing.

MATERIAL DE LA PARED: Albañilería (hormigón o ladrillo);
SISTEMA DE FIJACIÓN: Tornillo de fijación con buje de plástico.

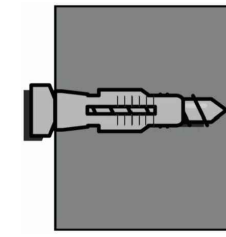

8

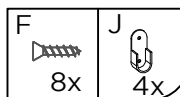
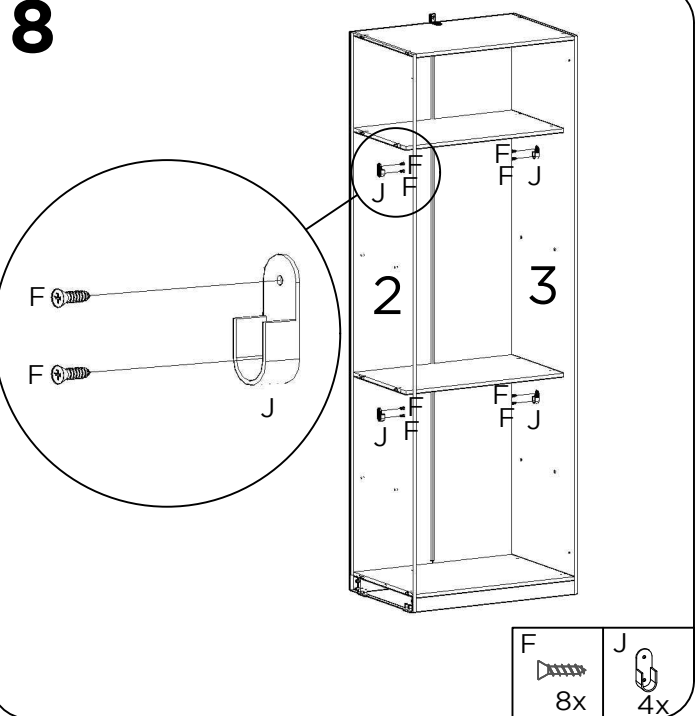

9

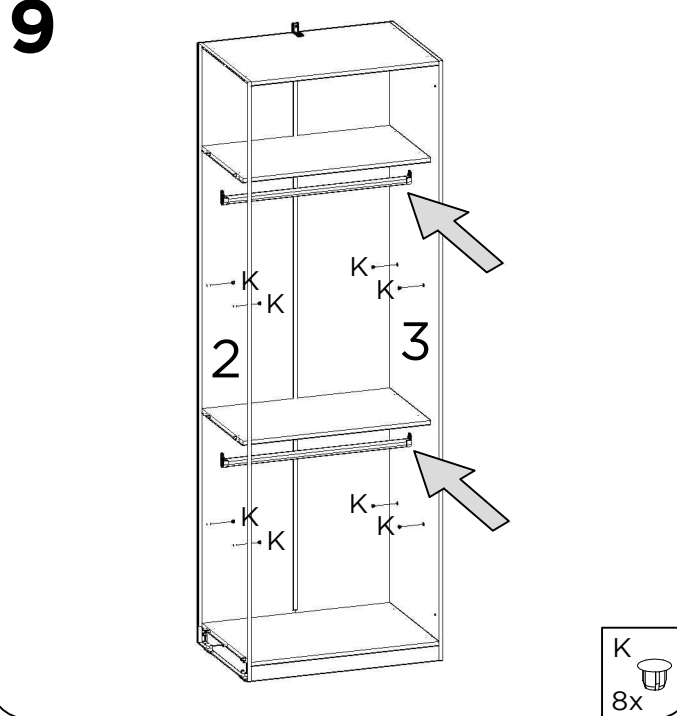

10

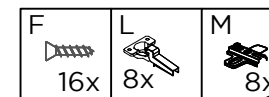
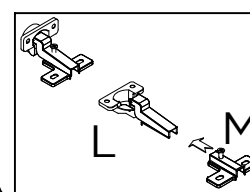
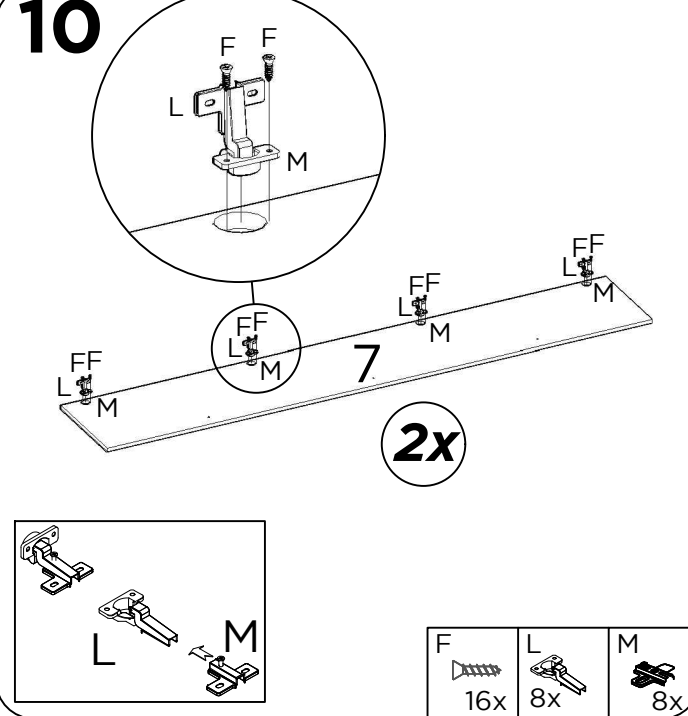

13

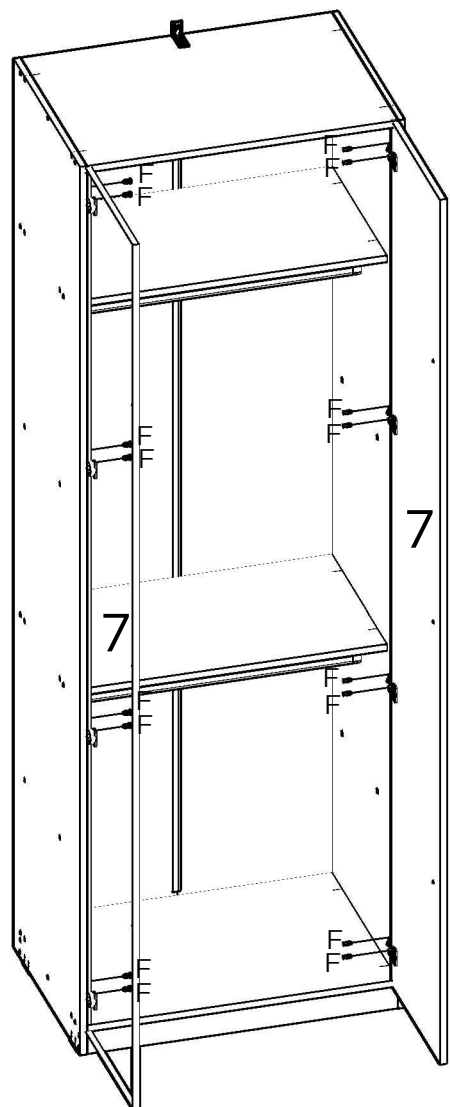



F

 16x

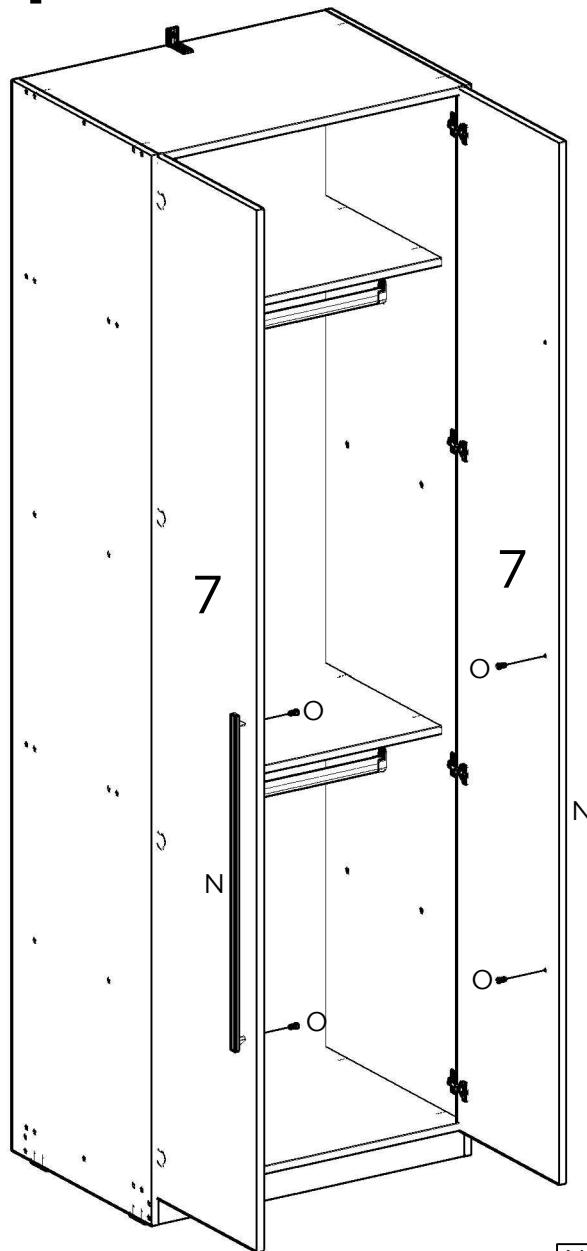
14



Z

 2x

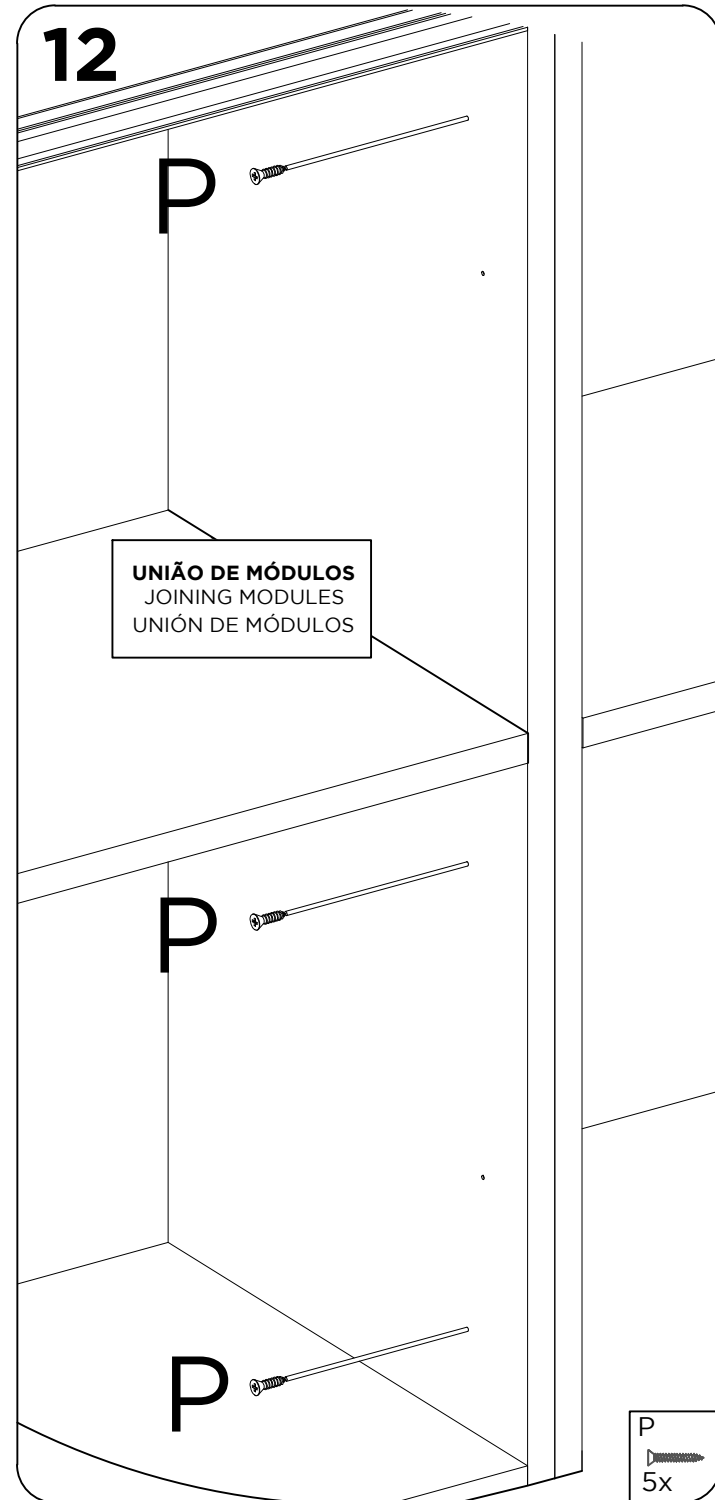
 4x

12



UNIÃO DE MÓDULOS
 JOINING MODULES
 UNIÓN DE MÓDULOS

P

 5x