





















FERRAGENS / herrajes / hardware

A	Parafuso 3,5 x 40 Tornillo 3,5 x 40 Screw 3,5 x 40		24
B	Puxador Tirador Handle		2
C	Roldanas		4
D	Parafuso 3,5 x 25 c/c Tornillo 3,5 x 25 Screw 3,5 x 25		6
E	Prego 10 x 10 c/c Clavo 10 x 10 Nail 10 x10		80
F	Parafuso 3,5 x 12 c/c Tornillo 3,5 x 12 Screw 3,5 x 12		50
G	Prego 13 x 15 c/c Clavo 13 x 15 Nail 13 x 15		4
H	Fixador Fijador Fixer		10
I	Suporte Apoyo Support		8
J	Suporte Cabideiro Apoyo Percha Support Hanger		4
K	Cantoneira 22x22 Esquinera Corner		10
L	Sapata Zapata Shoe		6
M	Cavilha 6 x 30 Tacos Pegs		4
N	Corrediça Metálica 350mm Corrediza Slider		1
O	Distanciador p/ Corrediças Distanciador Distancer		4
P	Parafuso 3,5 x 16 c/c Tornillo 3,5 x 16 Screw 3,5 x 16		12
Q	Parafuso 3,5 x 14 c/c Tornillo 3,5 x 14 Screw 3,5 x 14		6
R	Cola Pegamento Glues		1
T	Trilho pvc (U) superior		1
Z	Trilho aluminio inferior		1

MATERIAL PARA MONTAGEM Material Para Armado / Assembly Material

MARTELO
Martillo
Hammer

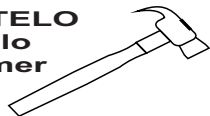

CHAVE
Destornillador
Screwdriver

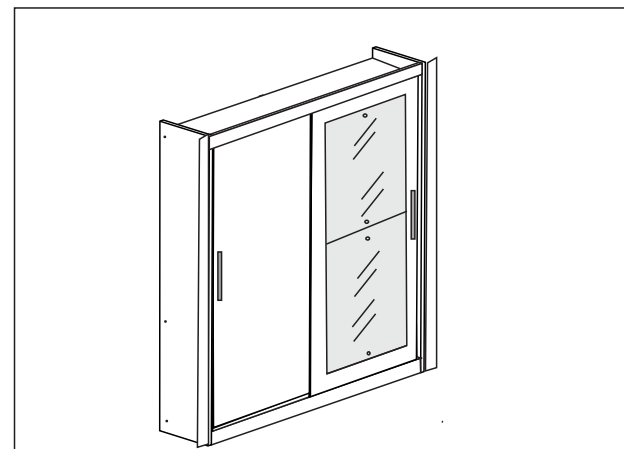
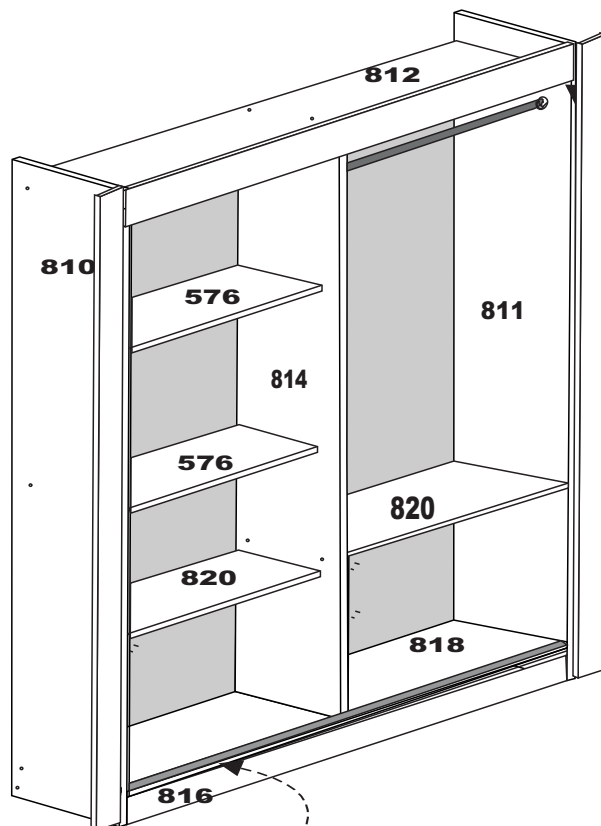

NUMERAÇÃO DE PEÇAS

810	Lateral Esquerda / Lateral izquierda/ left side
811	Lateral direita / Lateral derecha/ right side
816	Rodapé Frontal / Rodepié Frente/ front footer
816	Rodapé traseiro / Rodepié trazoero/ back drawer
815	Roda-forro / Roda-forro/wheel - liner
809	Costas / Espalda/ back
808	Porta / Puerta/big door
812	Tampo superior / Tampo superior/ top higher
818	Tampo baixo / Tampo abajo/ top dawn
814	Divisão / División
576	Prateleira Móvel / Prateleira Mueble/mobile
820	Prateleiras fixa

ACESSÓRIOS

N°	DESCRIÇÃO
137	Pau cabide / Madera percha/stick hanger
101	Espelhos

1° Passo / 1 Paso / 1 Step

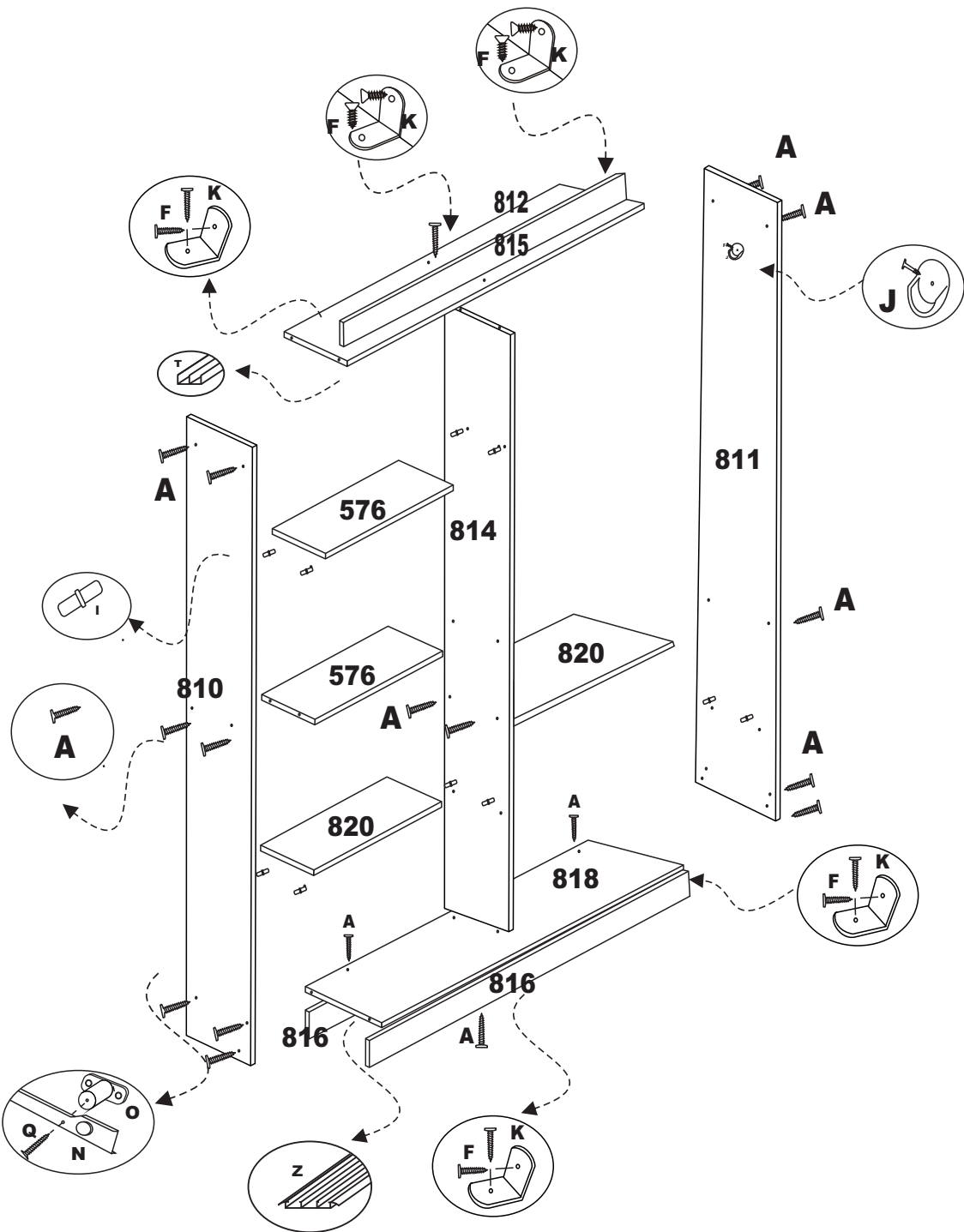

2° Passo / 2 Paso / 2 Step

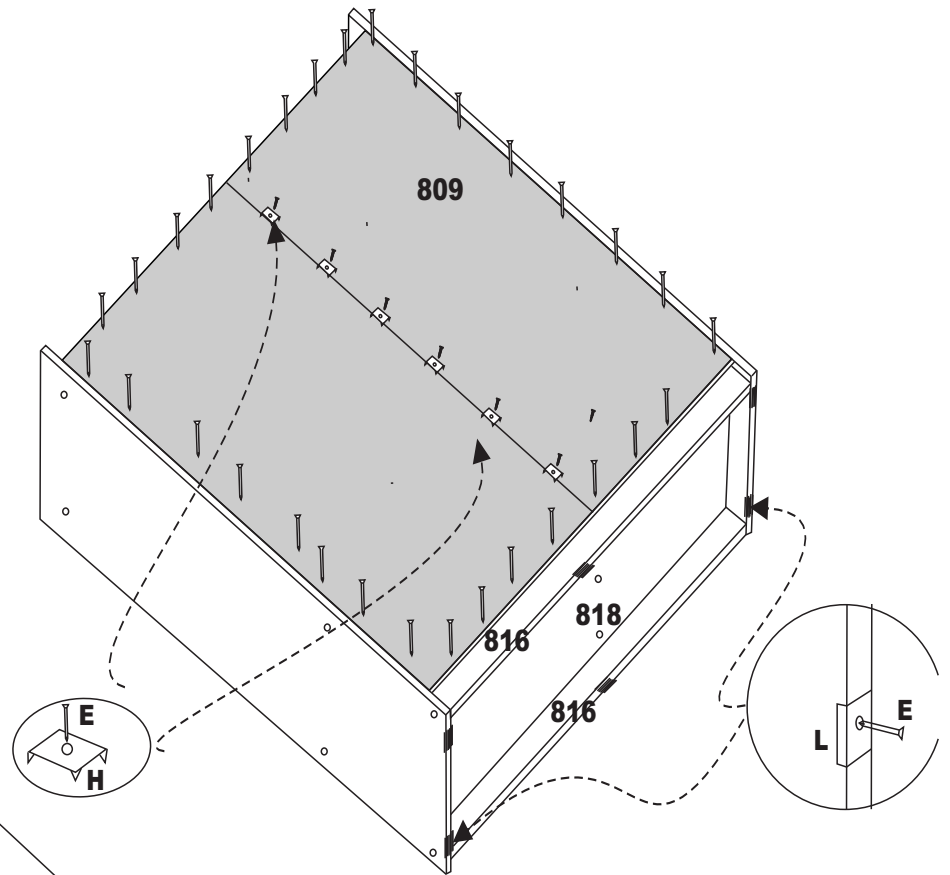

ATENÇÃO MONTAGEM TRILHOS

3º Passo / 3 Paso / 3 Step

Obs:
Na parte de cima, encaixa a porta dentro do trilho 'U'.

Observación:
En la parte superior, se ajusta a la puerta en la barra 'U'.

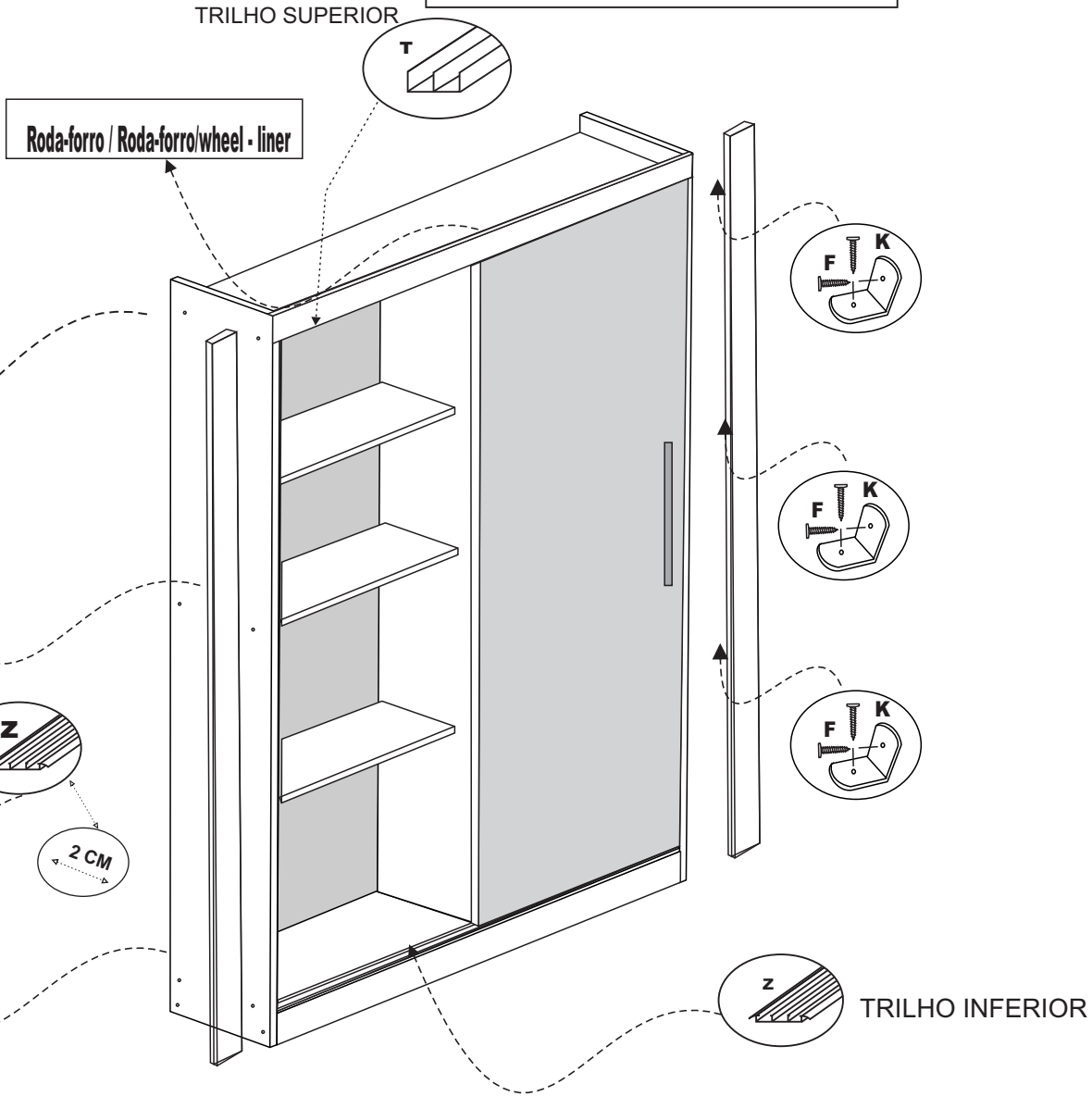
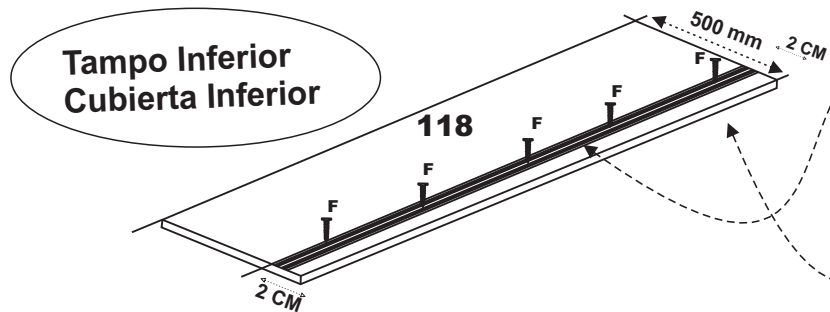
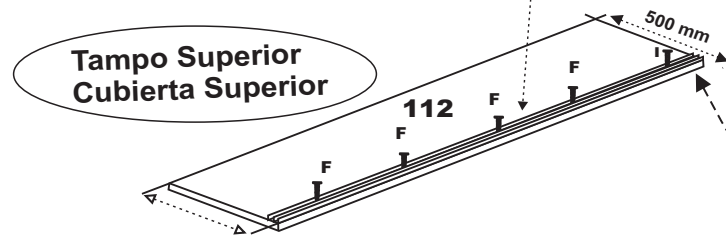
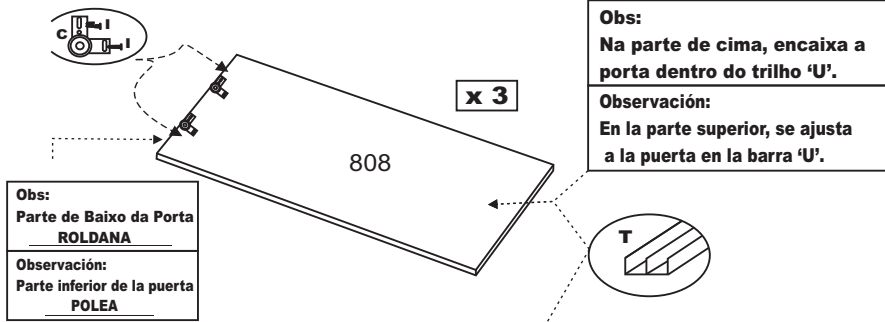

FIXAR APLIQUE LATERAL COM CANTONEIRAS

ATENÇÃO MONTAGEM PORTAS ESPELHOS.PUXADORES

4º Passo / 4 Paso / 4 Step

*Por puxadores, portas lateral
do roupeiro.*



PARA INICIAR A MONTAGEM ESPELHO
DEIXANDO A MEDIDA LATERAL COM ... MM CADA
LADO DA PORTA.
COMO MOSTRA DESENHO
E EMPARAFUSAR O ESPELHOS NA PORTA.