











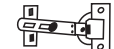

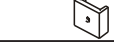

FERRAGENS / herrajes / hardware

A	Parafuso 3,5 x 40 Tornillo Screw	
B	Puxador Tirador Handle	
C	Dobradiça metálica Bisagra Hinge	
D	Parafuso 3,5 x 25 c/c Tornillo 3,5 x 25 Screw 3,5 x 25	
F	Parafuso 3,5 x 12 c/c Tornillo 3,5 x 12 Screw 3,5 x 12	
G	Prego 10 x 10 c/c Clavo 10 x 10 Nail 10 x 10	
H	Prego 13 x 15 c/c Clavo 13 x 15 Nail 13 x 15	
I	Cavilha 6 x 50 Tacos	
J	Suporte Cabideiro Apoyo Percha Support Hanger	
K	Cantoneira Esquinera Corner	
L	Sapata PÉ ROUPEIRO Shoe	
M	Cavilha 6 x 30 Tacos Pegs	
N	Corrediça Corrediza Slider	
P	Parafuso 4,0 X 16 c/c Tornillo 3,5 x 20 Screw 3,5 x 20	
Q	Parafuso 3,5 X 20 Tornillo 3,5 x 20 Screw 3,5 x 20	
R	Calço para dobradiças	

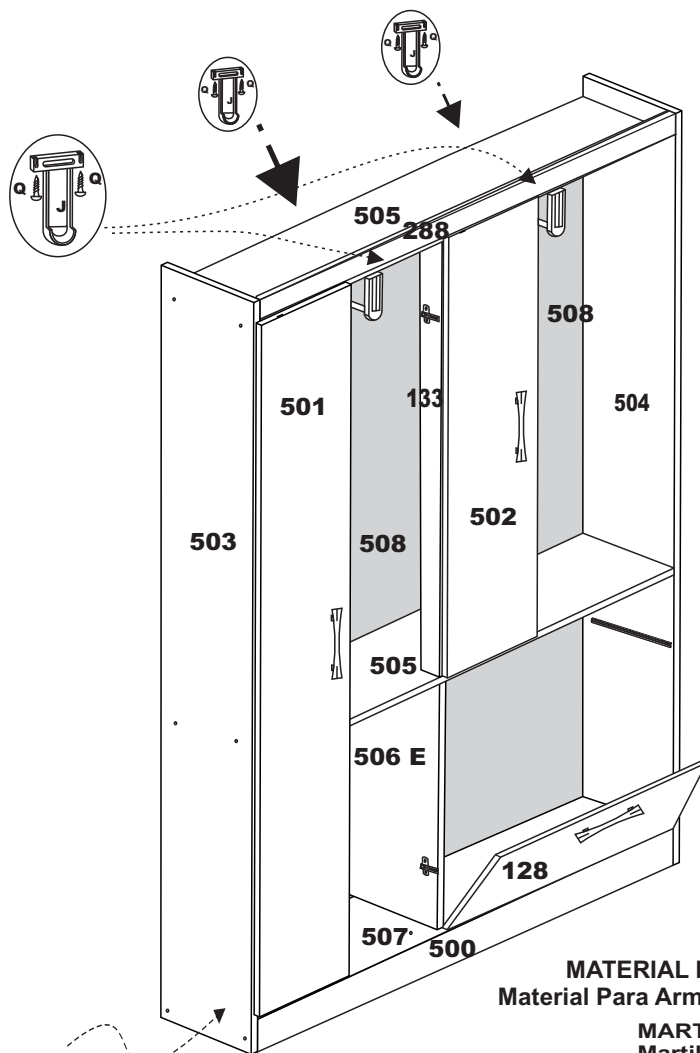

TAMPO BAIXO É DE 6 MM

MATERIAL PARA MONTAGEM

Material Para Armado / Assembly Material

MARTELO
Martillo
Hammer



CHAVE
Destornillador
Screwdriver

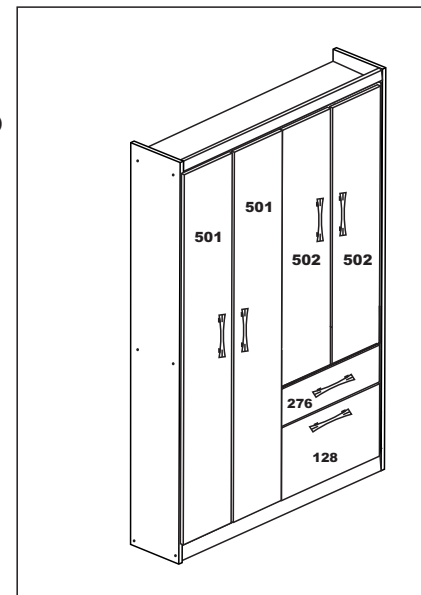

NUMERAÇÃO DE PEÇAS

N°	DESCRIÇÃO
503	Lateral Esquerda / Lateral izquierda/Left side
504	Lateral direita / Lateral derecha/Right side
500	Rodapé Frontal / Rodepié Frente/Front footer
500	Rodapé traseiro / Rodapié traseiro/Back drawer
288	Roda-forro / Roda-forro/wheel-liner
276	Frente gaveta / Delantera cajón/back drawer
122	Lateral gaveta / Lateral cajón/side drawer
137	Trazeiro gaveta / Trazeiro cajón/back side drawer
135	Fundo gaveta / Fondo cajón/back drawer
508	Costas / Espalda/back
501	Porta grande / Puerta grande/big door
502	Porta pequena / Puerta pequeña/little door
505	Tampo superior / Tampo superior/top higher
507	Tampo baixo / Tampo abajo/top down
505	Tampo meio / Tampo medio/
506	Divisão / División
128	Porta sapateira/ puerta/little
133	Pilastra / Pilastra
128	Gavetão / Cajón/front drawer

ACESSÓRIOS

N°	DESCRIÇÃO
	Pau cabide / Madera percha/stick hanger
	Perfil H / Perfil H/profile h

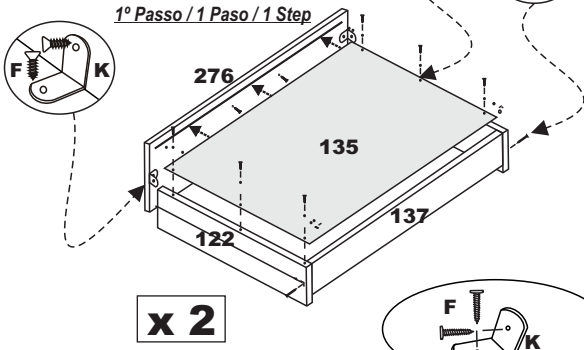

2º Passo / 2 Paso / 2 Step

uso obrigatório dos calços

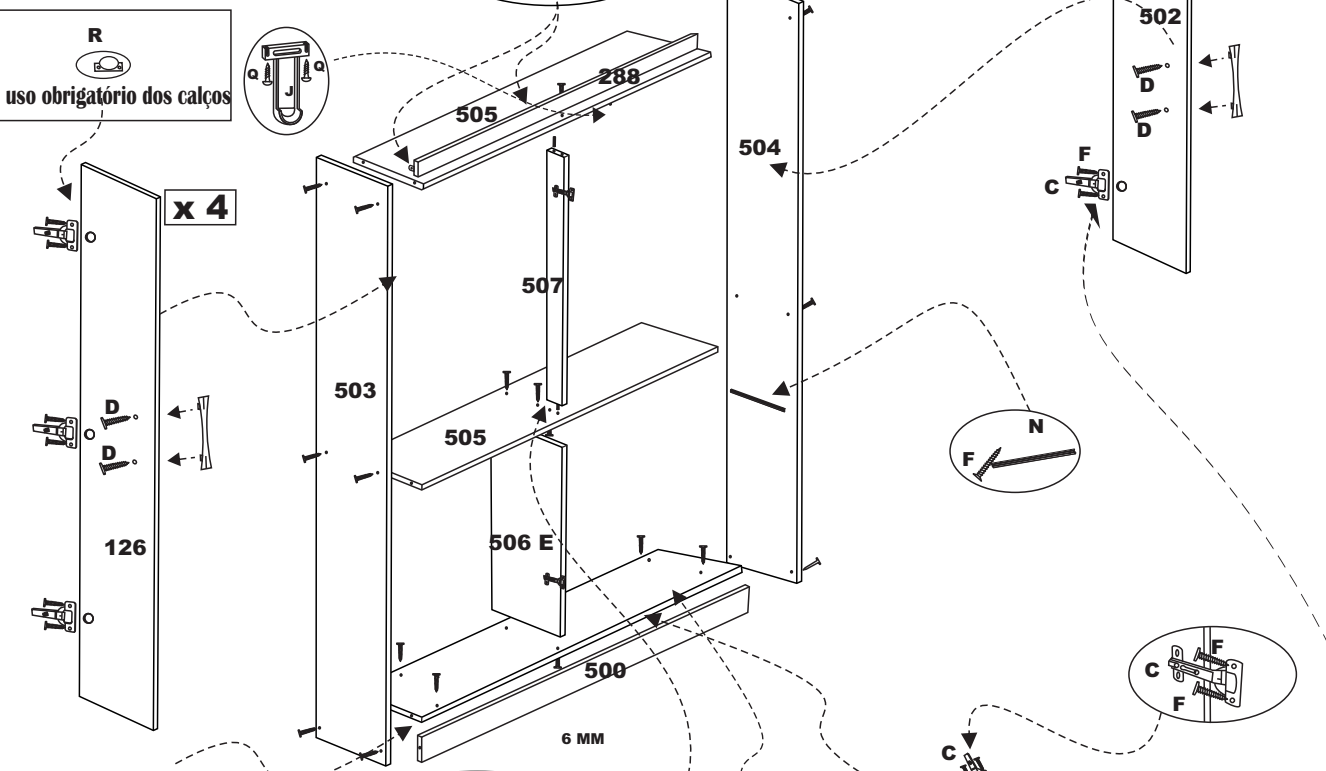

**TAMPO BAIXO É DE 6 MM
FIXAR PARAFUSO 3.5 X 40
NO RODAPÉ . COMO MOSTRA
O DESENHO**

usar cavilha 6x50
entre pilastra e divisão

USAR PARAFUSOS
4,0X16 P/FIXAR DOBRADIÇA
NO TAMPO. (P)

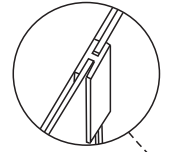
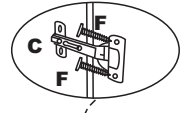

3º Passo / 3 Paso / 3 Step

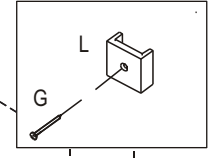
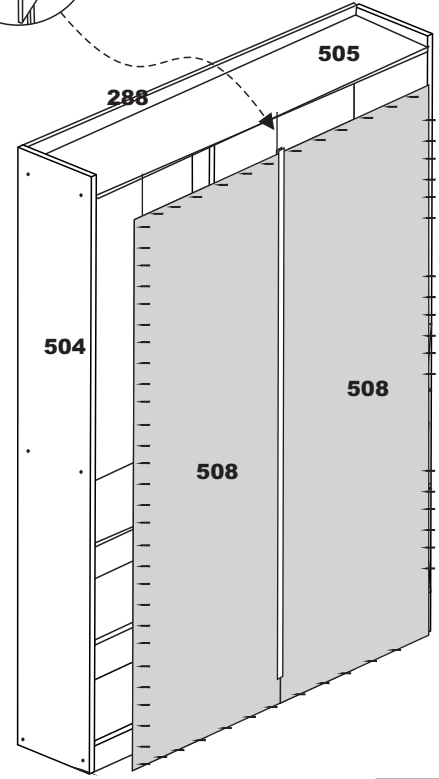

CALÇO PARA DOBRADIÇAS

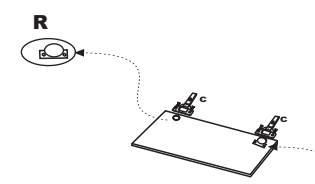

**uso obrigatório dos calços
nas dobradiças**

