

Roupeiro 02 Pts Deslizantes e 04 Gav. / Armario correderas 02 Pts y 04 Gav. /
Wardrobe 02 Pts Sliding and 04 Gav.

- BE25-66 - Branco/Branco/Rosa-Chá
- BE25-110 - Rústico/Rústico/Off White
- BE25-135 - Castanho HP/Castanho HP/Off White
- BE25-201 - Jequitibá Brilho/Jequitibá Brilho/Off White

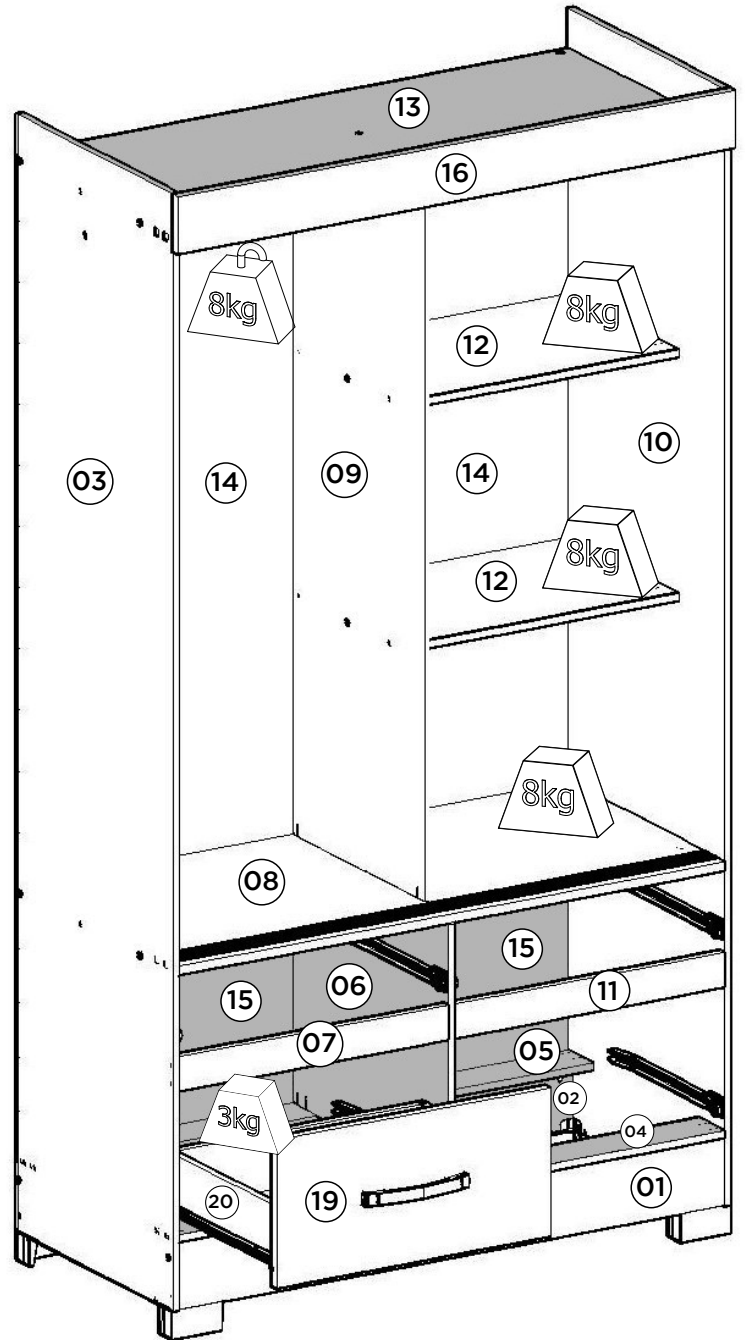

Requisitos para montagem
Requisitor para la montaje
Assembly Requirements

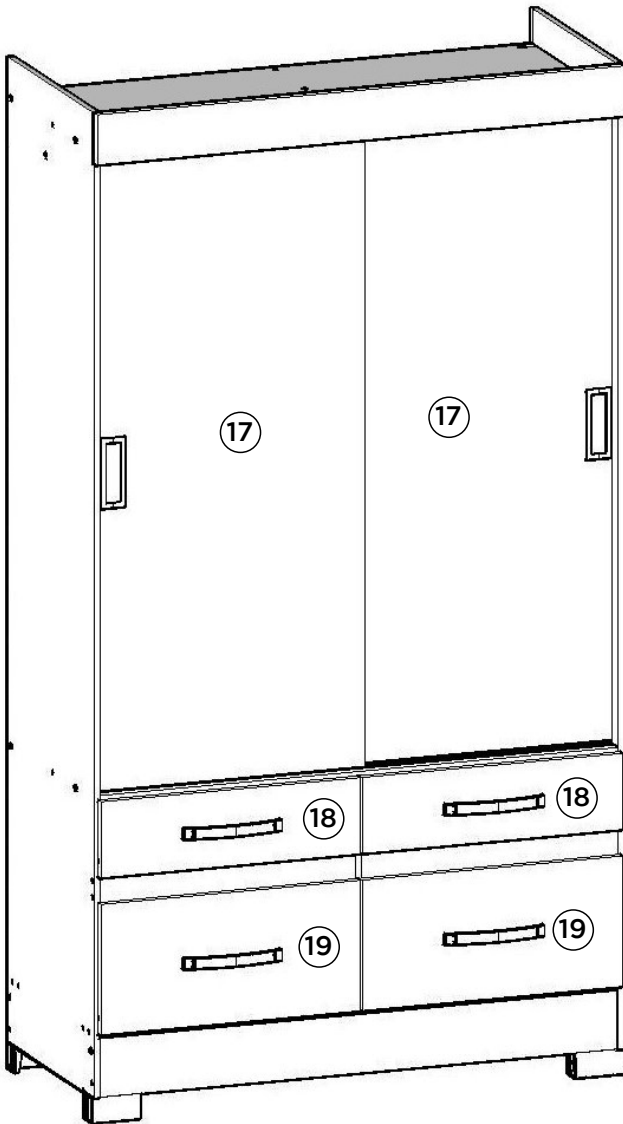
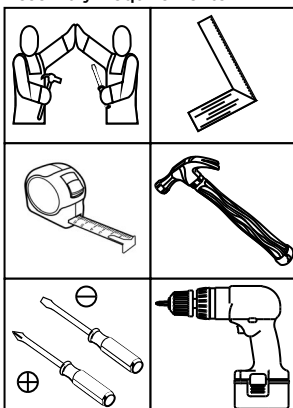

Imagens meramente ilustrativas
Imágenes meramente ilustrativas
Images for illustration only

Pesos máximos recomendados com carga distribuída
Peso máximo recomendado con la carga distribuida
Recommended maximum weights with evenly distributed.

1º

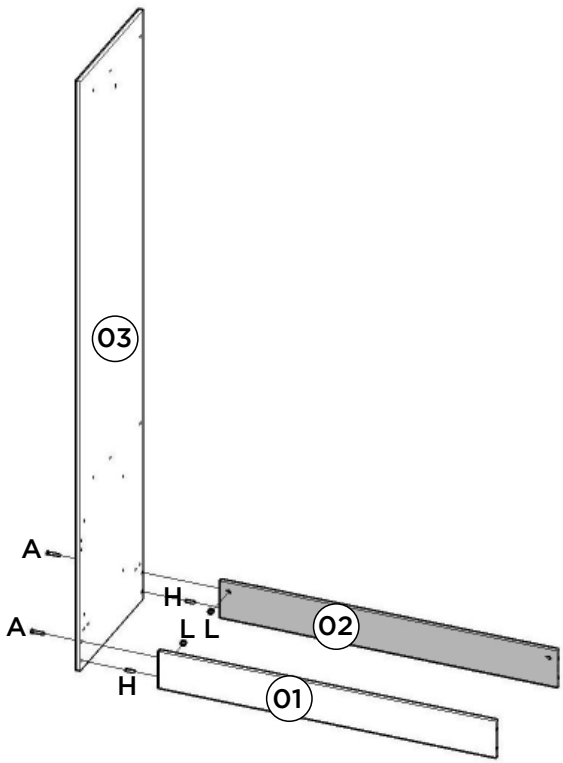

2º

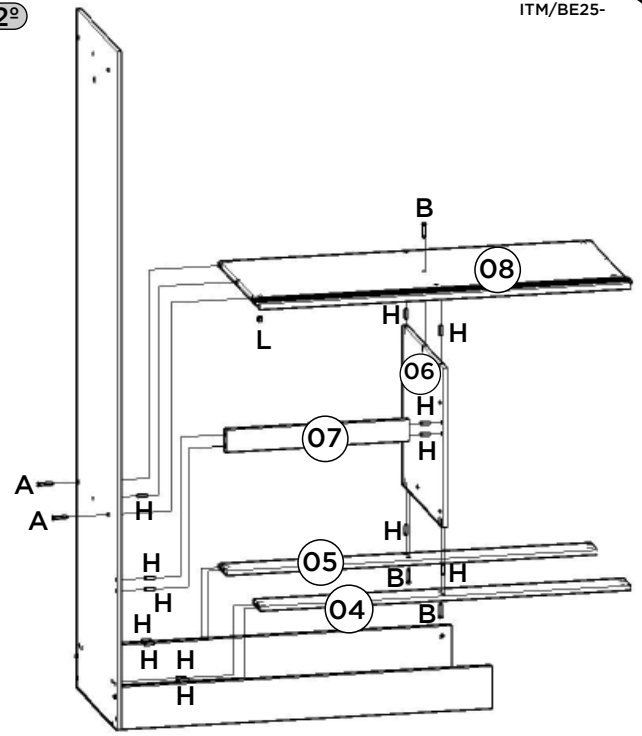

3º

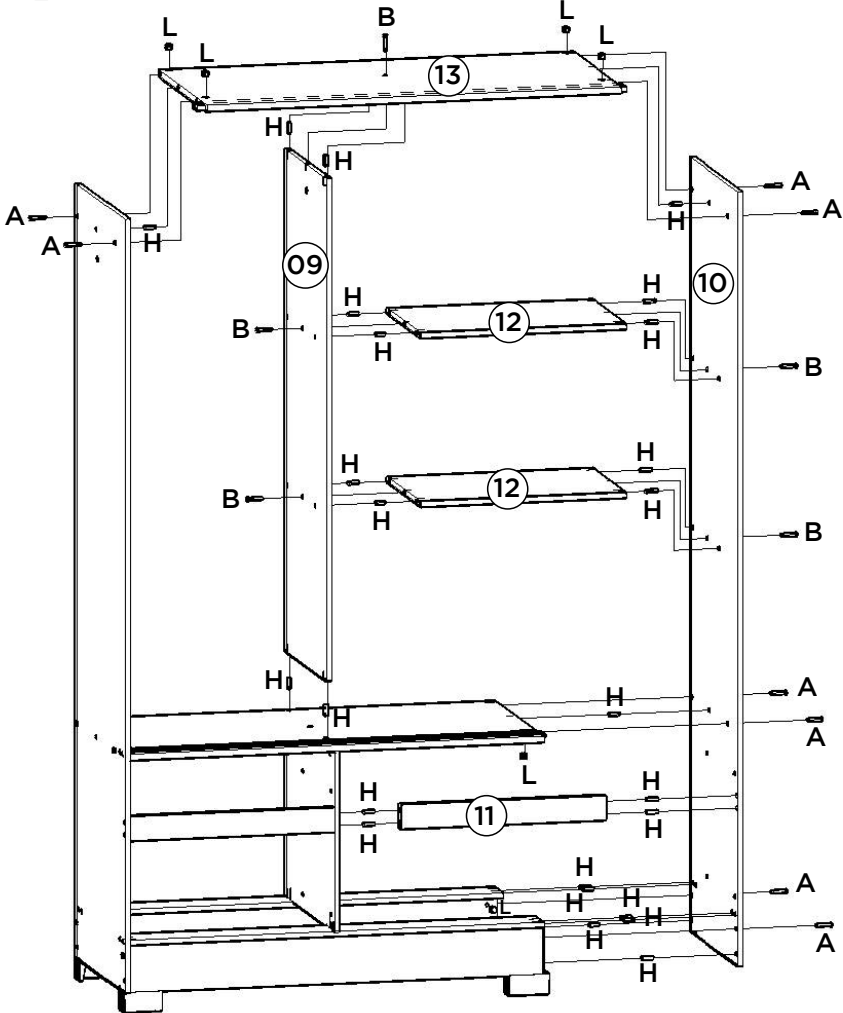

4º

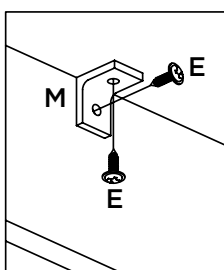
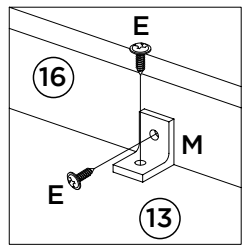
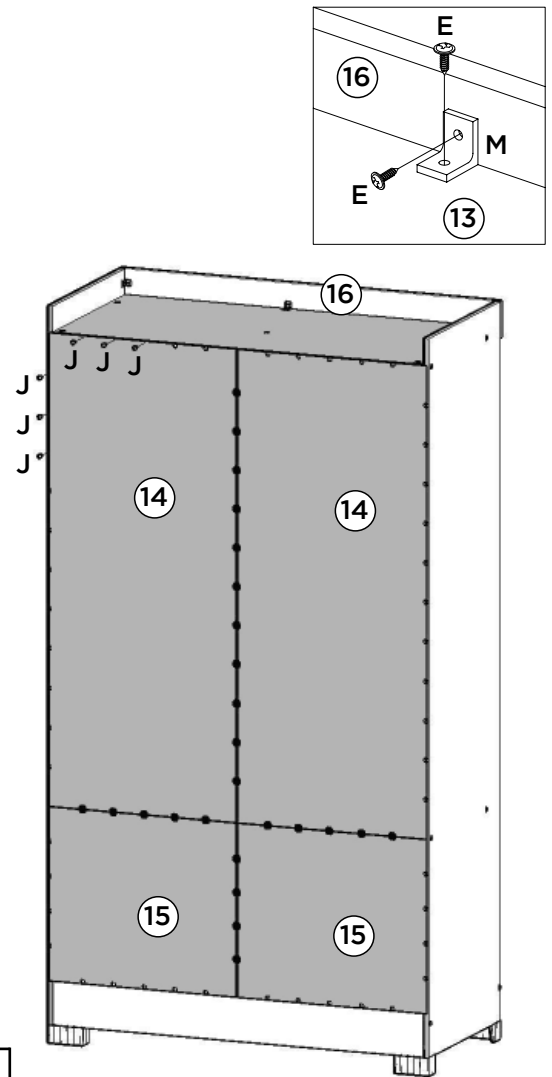

Fixação das 2 cantoneiras (M) nas peças nº (04) e (05) com as peças de nº (01) e (02).

La fijación de 2 ángulos (M) en el número piezas (04) y (05) con el número de piezas (01) y (02).

Fixing the 2 angle brackets (M) on parts nº (04) and (05) with the parts nº (01) and (02).

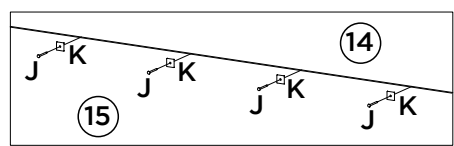
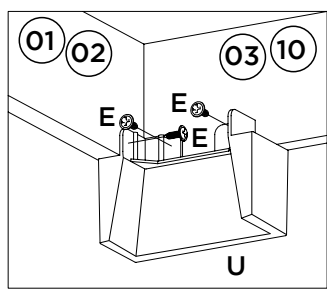

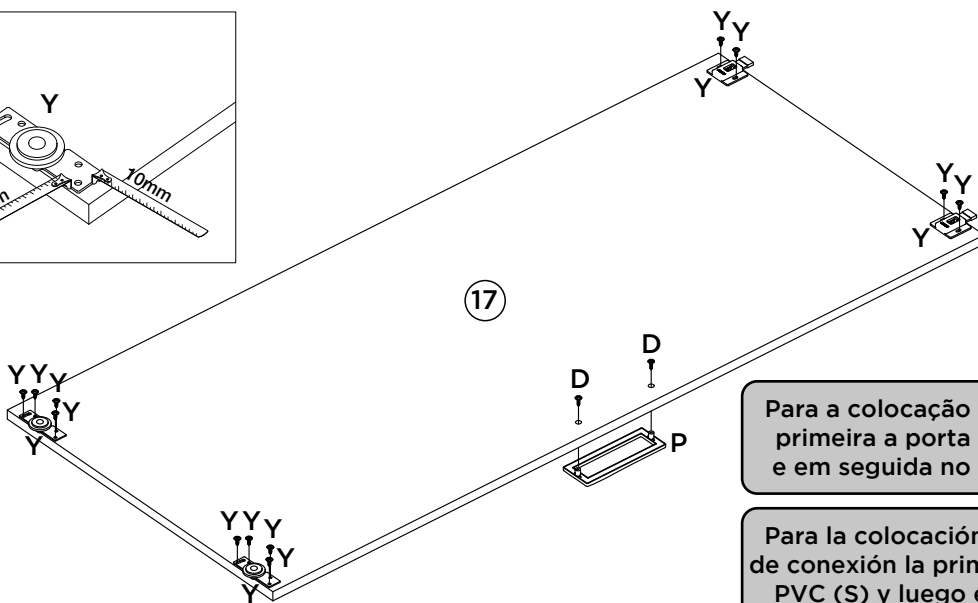
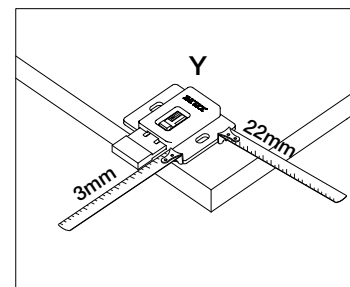
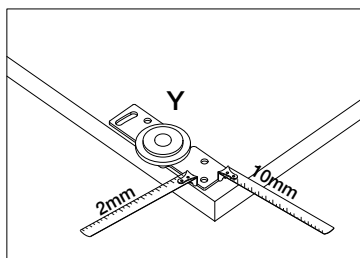

Para a colocação das portas nos trilhos encaixe primeira a porta no trilho de PVC superior (S) e em seguida no trilho de alumínio inferior (R)

Para la colocación de los puertos en los carriles de conexión la primera puerta en el carril superior PVC (S) y luego el riel de aluminio inferior (R)

To place the doors in the rails, first fit the dor in the top PVC rail (S) and then in the bottom aluminum rail (R).

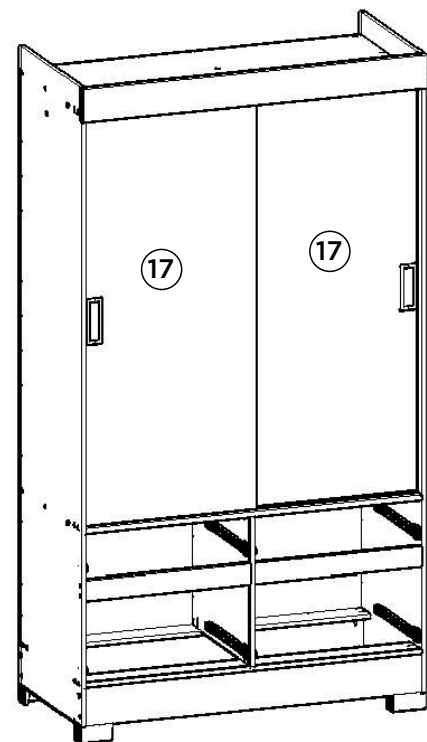
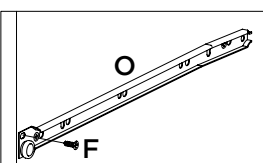
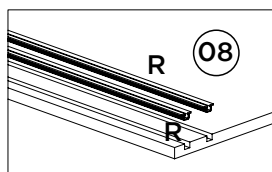
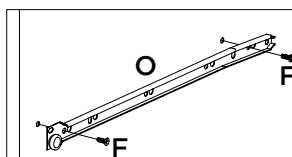
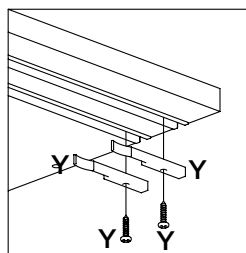
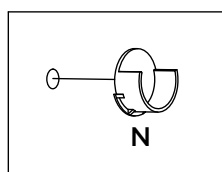
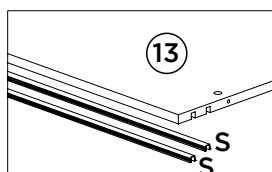
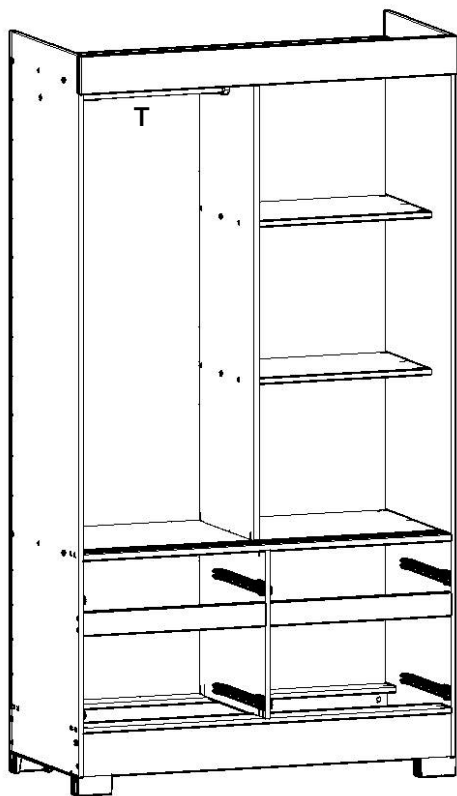



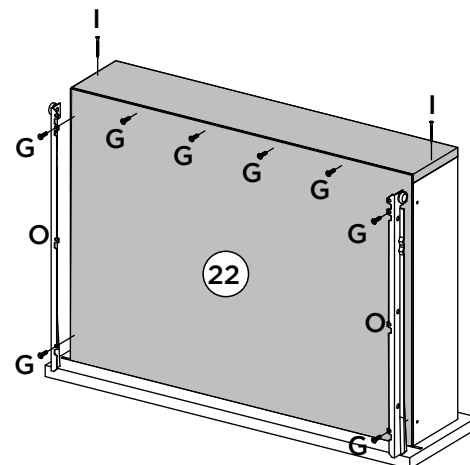
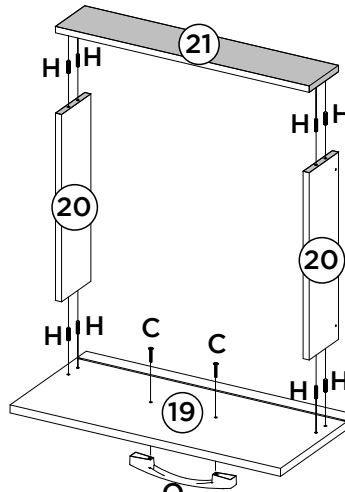
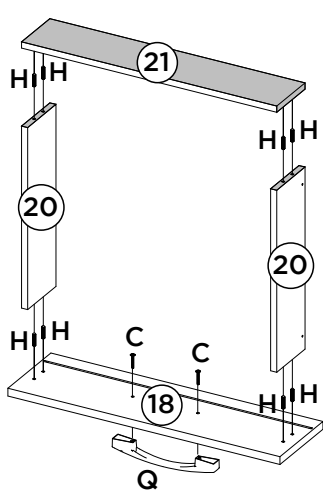
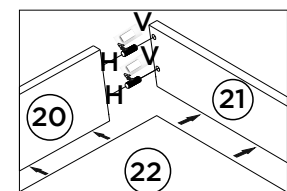
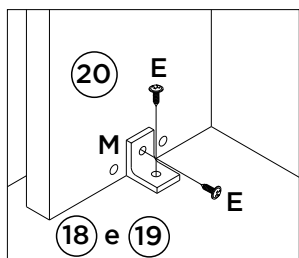







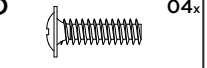

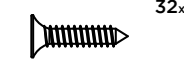
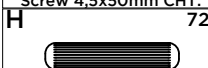
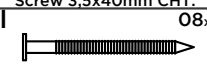
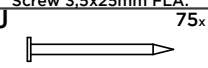
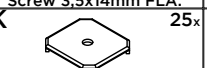

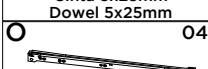

Video: Dicas para instalar corredeira
 Video: consejos para instalar la diapositiva
 Video: Tips for installing slide

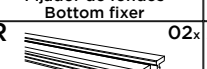
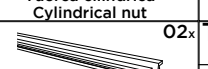
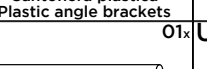

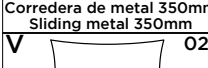
Item	Caixa Caja Box	Qtd Ctd Qty	Descrição Descripción Description	Medidas (mm) Dimensions (mm) Size (measure- ments) (mm)
01	1/2	01	Rodapé frontal Pie frontal Front footboard	1062x120x12
02	1/2	01	Rodapé traseiro Pie trasero Rear footboard	1062x120x12
03	1/2	01	Lateral esquerda Lateral izquierdo Left side	1955x465x12
04	1/2	01	Travessa base frontal Base delantera travesaño Front base tray	1062x80x12
05	1/2	01	Travessa base traseira Base posterior travesaño Rear base tray	1062x80x12
06	2/2	01	Divisão das gavetas División de cajones Drawers division	465x456x12
07=11	2/2	01	Travessa frontal Travesaño delantero Front tray	525x60x12
08	1/2	01	Tampo das gavetas Cubre los cajones Drawers cover	1062x465x12
09	2/2	01	Divisão División Division	1273x385x12
10	1/2	01	Lateral direita Lateral derecho Right side	1955x465x12
11=07	2/2	01	Travessa frontal Travesaño delantero Front tray	525x60x12
12	2/2	02	Prateleira Estante shelf	525x350x12
13	1/2	01	Tampo superior Cubierta superior Top cover	1062x465x12
14	2/2	02	Fundo Fondo Bottom	1290x540x3
15	2/2	02	Fundo cru Fondo raw Raw bottom	540x473x3
16	2/2	01	Chapéu Sombrero Hat	1084x100x15
17	2/2	02	Porta Puerta Door	1258x546x15
18	1/2	02	Frente de gaveta Frente del cajón Drawer front	533x152x15
19	1/2	02	Frente de gaveta maior Frente del cajón mayor Bigger drawer front	533x260x15
20	1/2	08	Lado de gaveta Lado del cajón Drawer side	350x100x12
21	1/2	04	Ripa de trás Listón trasero Rear batten	500x100x12
22	1/2	04	Fundo de gaveta Fondo del cajón Drawer bottom	499x367x3

FERRAGENS | HERRAJES | HARDWARE

A  Parafuso 4,5x50mm CHT. Tornillo 4,5x50mm CHT. Screw 4,5x50mm CHT.	B  Parafuso 3,5x40mm CHT. Tornillo 3,5x40mm CHT. Screw 3,5x40mm CHT.	C  Parafuso 3,5x25mm FLA. Tornillo 3,5x25mm FLA. Screw 3,5x25mm FLA.	D  Parafuso 3,5x14mm FLA. Tornillo 3,5x14mm FLA. Screw 3,5x14mm FLA.	E  Parafuso 3,5x12mm FLA. Tornillo 3,5x12mm FLA. Screw 3,5x12mm FLA.	F  Parafuso 3,5x12mm CHT. Tornillo 3,5x12mm CHT. Screw 3,5x12mm CHT.	G  Parafuso 3,0x16mm CHT. Tornillo 3,0x16mm CHT. Screw 3,0x16mm CHT.	
H  Cavilha 5x25mm Cinta 5x25mm Dowel 5x25mm	I  Prego 12x12mm Anelado Clavo 12x12mm Anillado Ringed Nails 12x12mm	J  Prego 10x10mm Clavo 10x10mm Nail 10x10mm	K  Fixador de fundos Fijador de fondos Bottom fixer	L  Porca cilíndrica Tuerca cilíndrica Cylindrical nut	M  Cantoneira plástica Cantonera plástica Plastic angle brackets	N  Suporte cabideiro Soporte de percha Coat hanger support	
O  Corrediza metal 350mm Corredera de metal 350mm Sliding metal 350mm	P  Puxador Square 128mm Tirador Square 128mm 128mm Square Handle	Q  Puxador Indonésia 128mm Tirador Indonésia 128mm 128mm Indonésia Handle	R  Trilho Alumínio 1060mm Riel Aluminio 1060mm 1060mm aluminum rails	S  Trilho PVC 1060mm Carril PVC 1060mm 1060mm PVC rails	T  Cabideiro Madeira 519mm Cabezal Madera 519mm 519mm wooden hanger	U  Pé "U" 50x40x100mm Pie "U" 50x40x100mm 50x40x100mm "U" feet	
V  Sachê de cola Bolsa de pegamento Glue bag	W  Adesivo tapa parafuso 10mm Adhesivo tapón de tornillo 10mm Bolt cover adhesive 10mm	X  Etiqueta resinada Briz Etiqueta resinada Briz Briz resin label	Y  Kit Roldana JM300 (2Portas) Kit Roldán JM300 (2Puertas) JM300 Pulley Kit (2Doors)				

AVISO

Para limpeza de seu móvel, use uma flanela seca ou umedecida, e não utilize produtos químicos que possam danificar seu produto.

SISTEMA DE MONTAGEM

O sistema de montagem dos produtos, funciona de acordo com a ordem crescente dos números indicados no desenho. Ex: 01, 02, 03, 04... até a conclusão da montagem.

ASSISTÊNCIA TÉCNICA

Para solicitação de Assistência Técnica você consumidor deverá entrar em contato com o Lojista o qual você realizou a compra deste produto e solicitar a assistência técnica das peças avariadas. A garantia abrange todas as peças, partes e componentes que eventualmente venham apresentar defeito de fabricação no prazo de 03 (três) meses, contando a partir da entrega do produto ao consumidor, mediante nota fiscal de compra. Se houver qualquer alteração na estrutura do produto ou ocorrer defeito por negligência do montador/consumidor em relação a instrução de montagem e manuseio, não será fornecido assistência técnica gratuita.

ADVERTENCIA

Para limpieza de su móvil, use una flanela seca o húmeda, y no utilice productos químicos que puedan dañar su producto.

SISTEMA DE MONTAJE

El sistema de montaje de los productos funciona de acuerdo con el orden creciente de los números indicados en el dibujo. Ej.: 01, 02, 03, 04... hasta la conclusión del montaje.

ASSISTENCIA TÉCNICA

Para solicitar Asistencia Técnica, el consumidor debe comunicarse con el Comercio que usted realizó la compra de este producto y solicita asistencia técnica para las partes dañadas. La garantía cubre todas las partes, piezas y componentes que eventualmente puedan presentar defecto de fabricación en el plazo de 03 (tres) meses, contados a partir de la entrega del producto al consumidor, mediante factura de compra. Si se produce algún cambio en la estructura del producto o se produce un defecto por negligencia del montador/consumidor en relación con las instrucciones de montaje y manipulación, no se prestará asistencia técnica gratuita.

NOTICE

To clean your furniture, use a dry or wet cloth, and do not use chemicals that may damage your product.

ASSEMBLY SYSTEM

The products' assembly system works according to the increasing order of the indicated numbers. For example: 01, 02, 03, 04 ... to the end of the assembly.

TECHNICAL ASSISTANCE

To request Technical Assistance, the consumer must contact the retailer from whom you purchased this product and request technical assistance for the damaged parts. The warranty covers all parts, parts and components that may eventually present a manufacturing defect within a period of 03 (three) months, counting from the delivery of the product to the consumer, by means of a purchase invoice. If there is any change in the structure of the product or defect occurs due to negligence of the assembler/consumer in relation to the assembly and handling instruction, free technical assistance will not be provided.

KIT ESPELHO 1050x350x3 COM 1 UNIDADE

c B02-64 - Prata

Item	Caixa	Qtd	Descrição	Medidas (mm)	Código
01	1/1	01	Espelho	1050x350x3	01100129

Exemplo: Porta de correr
1252x546x15
(B21-88 Roupeiro 3Pts
Correr 6Gav)

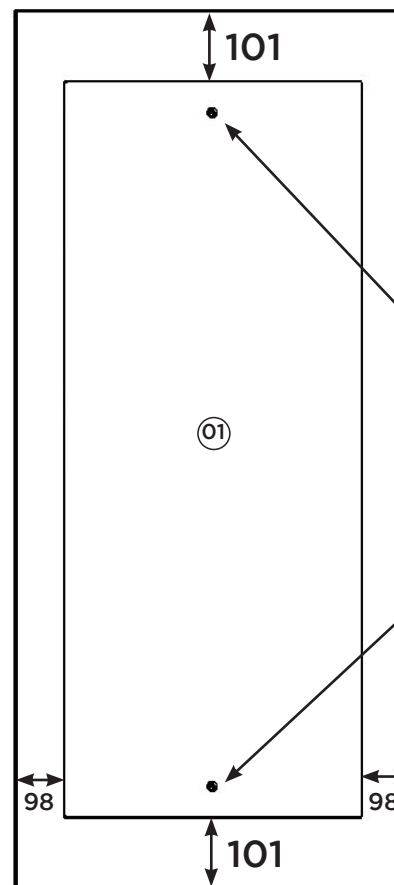

Fixar o Espelho com a Bucha (A) e o Parafuso (B)
Utilizar a parafusadeira com o torque 3.

AVISO

Para limpeza de seu móvel, use uma flanela seca ou umedecida, e não utilize produtos químicos que possam danificar seu produto.

SISTEMA DE MONTAGEM

O sistema de montagem dos produtos, funciona de acordo com a ordem crescente dos números indicados no desenho. Ex: 01, 02, 03, 04... até a conclusão da montagem.

Ferragens

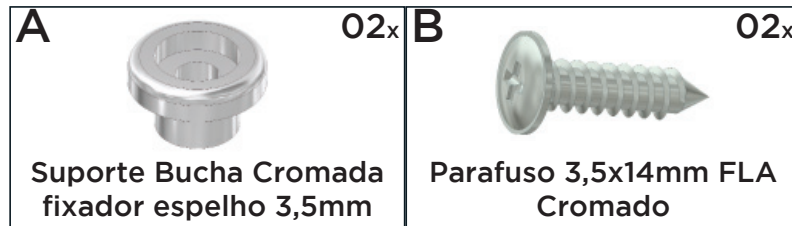

Medidas em mm

Requisitos para montagem

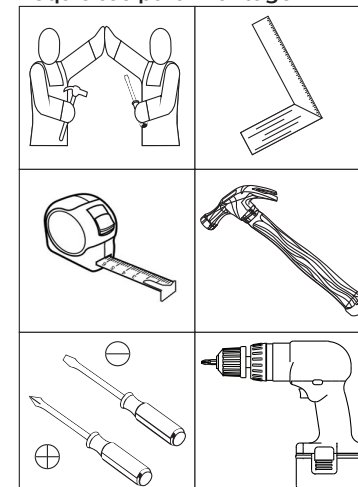

Imagens meramente ilustrativas