

HENN

Ind. e Com. de Móveis Henn
Mondai - SC - Brasil

+55 49 3674.3500

@moveishenn
www.henn.com.br

INSTRUÇÕES DE MONTAGEM

INSTRUCCIONES DE MONTAJE
ASSEMBLY INSTRUCTIONS

Canto Oblíquo 1 Porta Seletto | Esquina oblicua 1 Porta Seletto | Oblique Corner 1 Door Seletto

MC07-133 Areia HP

MC07-184 Areia HP/Jequitibá

Opção 1
Opción 1
Option 1

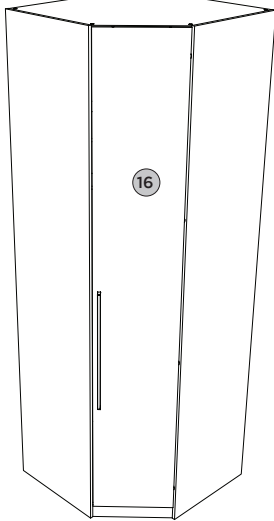

Opção 2
Opción 2
Option 2

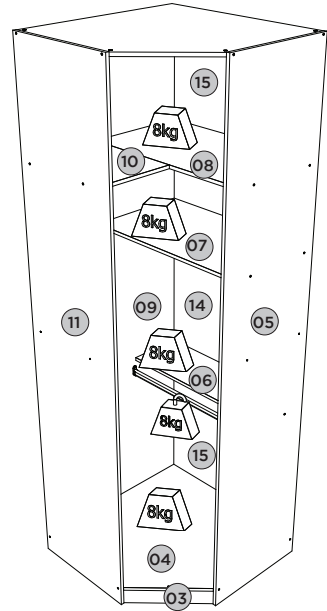
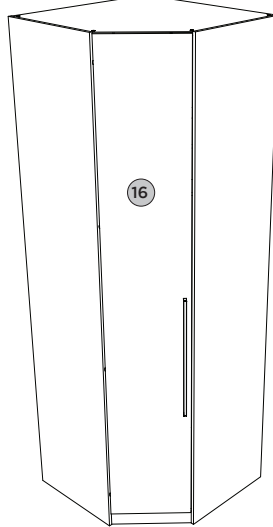

Pesos máximos recomendados com carga distribuída
Peso máximo recomendado con la carga distribuída
Recommended maximum weights with evenly distributed.

Requisitos para montagem Requisitor para la montaje Assembly Requirements

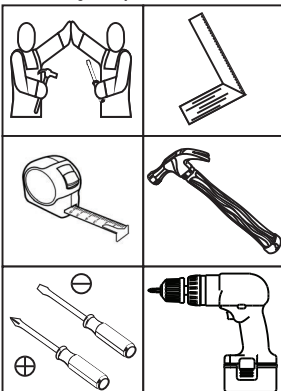

Imagens meramente ilustrativas
Imágenes meramente ilustrativas
Images for illustration only

AVISO

Para limpeza de seu móvel, use uma flanela seca ou umedecida, e não utilize produtos químicos que possam danificar seu produto.

SISTEMA DE MONTAGEM

O sistema de montagem dos produtos, funciona de acordo com a ordem crescente dos números indicados no desenho. Ex: 01, 02, 03, 04... até a conclusão da montagem.

ASSISTÊNCIA TÉCNICA

Para solicitação de Assistência Técnica você consumidor deverá entrar em contato com o Lojista o qual você realizou a compra deste produto e solicitar a assistência técnica das peças avariadas. A garantia abrange todas as peças, partes e componentes que eventualmente venham apresentar defeito de fabricação no prazo de 03 (três) meses, contando a partir da entrega do produto ao consumidor, mediante nota fiscal de compra. Se houver qualquer alteração na estrutura do produto ou ocorrer defeito por negligência do montador/consumidor em relação a instrução de montagem e manuseio, não será fornecido assistência técnica gratuita.

ADVERTENCIA

Para limpieza de su móvil, use una flanela seca o húmeda, y no utilice productos químicos que puedan dañar su producto.

SISTEMA DE MONTAJE

El sistema de montaje de los productos funciona de acuerdo con el orden creciente de los números indicados en el dibujo. Ej.: 01, 02, 03, 04... hasta la conclusión del montaje.

ASISTENCIA TÉCNICA

Para solicitar Asistencia Técnica, el consumidor debe comunicarse con el Comercio que usted realizó la compra de este producto y solicita asistencia técnica para las partes dañadas. La garantía cubre todas las partes, piezas y componentes que eventualmente puedan presentar defecto de fabricación en el plazo de 03 (tres) meses, contados a partir de la entrega del producto al consumidor, mediante factura de compra. Si se produce algún cambio en la estructura del producto o se produce un defecto por negligencia del montador/consumidor en relación con las instrucciones de montaje y manipulación, no se prestará asistencia técnica gratuita.

NOTICE

To clean your furniture, use a dry or wet cloth, and do not use chemicals that may damage your product.

ASSEMBLY SYSTEM

The products' assembly system works according to the increasing order of the indicated numbers. For example: 01, 02, 03, 04 ... to the end of the assembly.

TECHNICAL ASSISTANCE

To request Technical Assistance, the consumer must contact the retailer from whom you purchased this product and request technical assistance for the damaged parts. The warranty covers all parts, parts and components that may eventually present a manufacturing defect within a period of 03 (three) months, counting from the delivery of the product to the consumer, by means of a purchase invoice. If there is any change in the structure of the product or defect occurs due to negligence of the assembler/consumer in relation to the assembly and handling instruction, free technical assistance will not be provided.

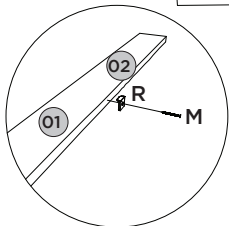
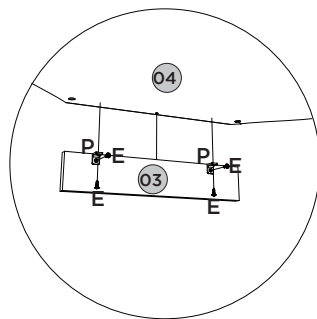
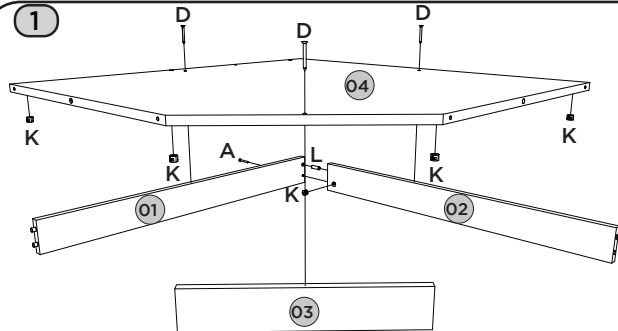

ATENÇÃO: Quando o Canto Obliquo for acoplado à Mesa de Cabeceira, a porta do Canto deverá abrir no sentido do Mesa de Cabeceira.

ATENCIÓN: Cuando la Esquina Inclinada se une a la Mesita de Noche, la puerta de la Esquina debe abrirse hacia la Mesita de Noche.

ATTENTION: When the Slanted Corner is attached to the Bedside Table, the Corner door must open towards the Bedside Table.

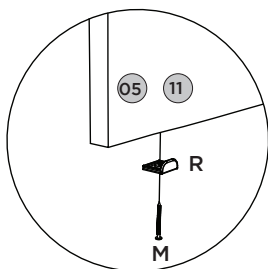
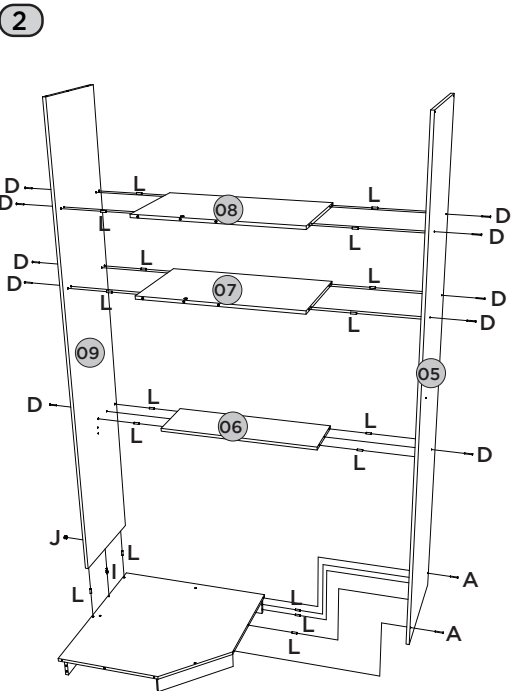

2

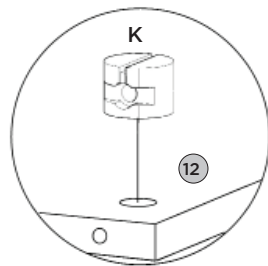
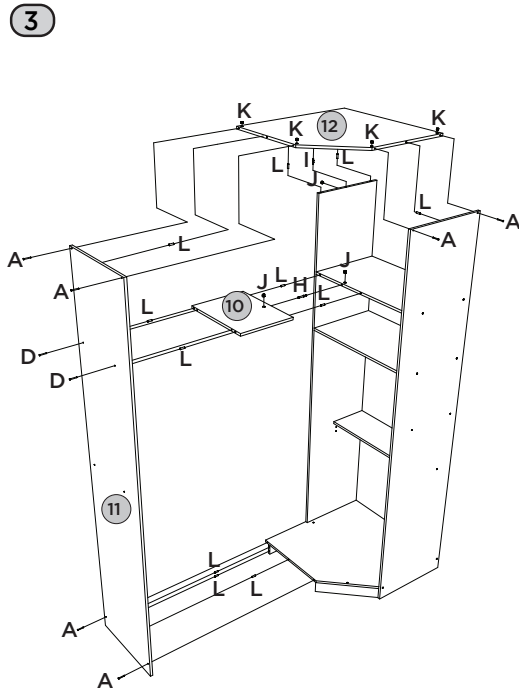

3

4

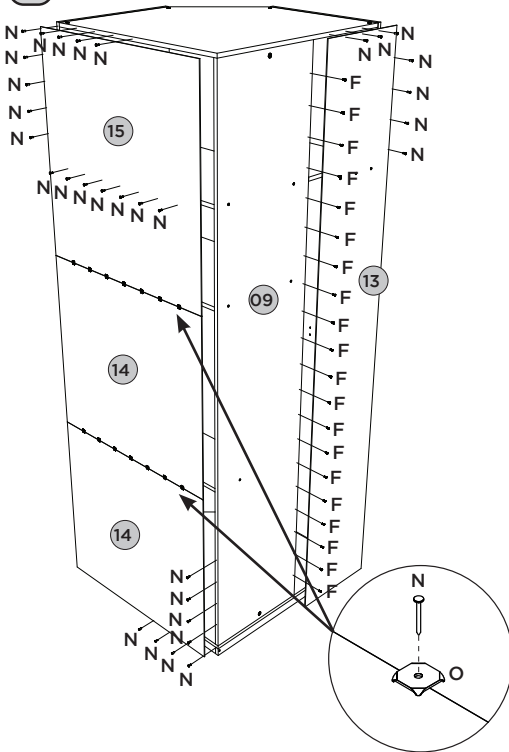

5

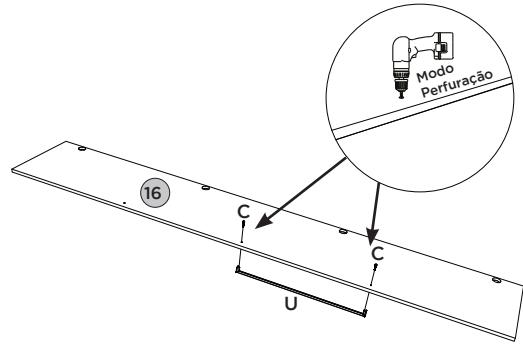

Fazer furação passante para fixar os puxadores, utilizando as pré marcações existentes nas portas.

Taladre agujeros para fijar las manijas, utilizando las marcas previas en las puertas.

Drill through holes to fix the handles, using the pre-markings on the doors.

6

Fazer furação passante para fixar o puxador, utilizando as pré marcações existentes nas portas.





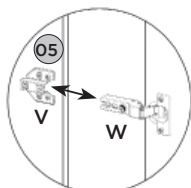
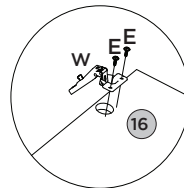
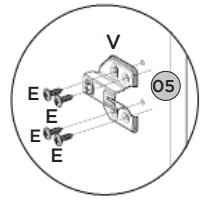
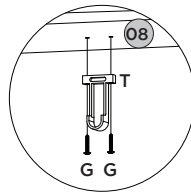
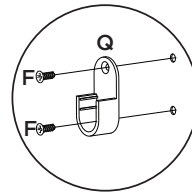
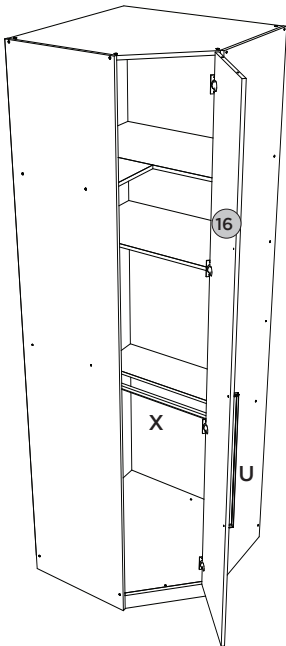











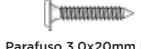
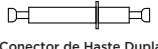
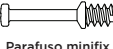



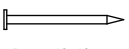

Taladre agujeros para fijar la manija, utilizando las marcas previas en las puertas.

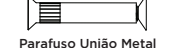
Drill through holes to fix the handle, using the pre-markings on the doors.

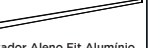

Item	Caixa Caja Box	Qtd Ctd Qty	Descrição Descripción Description	Medidas (mm) Dimensions (mm) Size (measurements) (mm)
01	1/3	01	Rodapé Traseiro Maior Rodapié trasero mayor Larger Back Footer	764x73x15
02	1/3	01	Rodapé Traseiro Menor Rodapié trasero menor Rear Footer Minor	749x73x15
03	1/3	01	Rodapé Frontal Rodapié Frontal Front baseboard	395x73x15
04	1/3	01	Base Base Base	796x796x15
05	2/3	01	Lateral direita Lateral derecha Right side	2400x520x15
06	1/3	01	Prateleira do varão Estantería hombre Rod shelf	781x520x15
07	1/3	01	Prateleira Estante Shelf	781x450x15
08	1/3	01	Prateleira fixa Estante fija Fixed shelf	781x450x15
09	2/3	01	Fundo 15mm Fondo 15mm 15mm Bottom	2296x450x15
10	1/3	01	Prateleira Menor Estante menor Minor shelf	346x450x15
11	2/3	01	Lateral esquerda Lateral izquierda Left side	2400x520x15
12	1/3	01	Tampo Tapa Top	796x796x15
13	2/3	01	Fundo Fondo Bottom	2324x370x3
14	1/3	02	Fundo Inferior Fondo inferior bottom background	730x805x3
15	1/3	01	Fundo Superior Fondo superior Superior background	854x805x15
16	3/3	01	Porta Puerta Door	2320x391x15

Ferragens | Herrajes | Hardware

A  Parafuso 4,5x50mm CHT. Tornillo 4,5x50mm CHT. Screw 4.5x50mm CHT.	B  Etiqueta resinada Henn Etiqueta resinada Henn Henn resin label	C  Parafuso 3,5x22mm CHT. Tornillo 3,5x22mm CHT. Screw 3.5x22mm CHT.	D  Parafuso 3,5x40mm CHT. Tornillo 3,5x40mm CHT. Screw 3.5x40mm CHT.	E  Parafuso 3,5x14mm FLA. Tornillo 3,5x14mm FLA. Screw 3.5x14mm FLA.	F  Parafuso 3,5x12mm CHT. Tornillo 3,5x12mm CHT. Screw 3.5x12mm CHT.
G  Parafuso 3,0x20mm FLA. Tornillo 3,0x20mm FLA. Screw 3.0x20mm FLA.	H  Conector de Haste Dupla Conector de vástago doble Double Stem Connector	I  Parafuso minifix Tornillo minifix Minifix bolt	J  Tambor minifix Tambor minifix Minifix drum	K  Porca cilíndrica Tuerca cilíndrica Cylindrical nut	L  Cavilha 8x25mm Cinta 8x25mm Dowel 8x25mm
M  Prego 12x12mm Anelado Clavo 12x12mm Anillado Ringed Nails 12x12mm	N  Prego 10x10mm Clavo 10x10mm Nail 10x10mm	O  Fixador de fundos Fijador de fondos Bottom fixer	P  Cantoneira plástica Cantoneira plástica Plastic angle brackets	Q  Suporte cabideiro Soporte de percha Coat hanger support	R  Sapata "L" 16x20mm Zapata "L" 16x20mm "L" shoe 16x20mm
S  Parafuso União Metal Tornillo Unión Metal Metal Union Screw	T  Suporte Cabid. "U" Fechado Soporte Cabid. "U" Cerrado Support Cabid. "U" Closed	U  Puxador Aleno Fit Alumínio Mango de aluminio Aleno Fit Aleno Fit Aluminum Handle	V  Calço Removível p Dob 45° Calzado extraíble p Dob 45° Removable chock p Dob 45°	W  dobradica 45° Caneca 35mm com Amortecimento Bisagra 45° Taza 35mm con Amortiguación Hinge 45° Mug 35mm with Damping	X  Cabideiro Alum. 384mm Alum. 384mm percha Alum. coat hanger 384mm
Y  Cabideiro Alum. 773mm Alum. 773mm percha Alum. coat hanger 773mm	Z  Adesivo tapa parafuso 10mm Adhesivo tapón de tornillo 10mm Bolt cover adhesive 10mm	AA  Giz de correção Tiza de corrección Chalk of correction			

A união (S) deve ser usada somente quando este módulo for acoplado a outro módulo componível Henn, para unir duas peças de 15mm. Caso ele seja usado separadamente, a utilização do união não se faz necessário.

La unión (S) se debe utilizar sólo cuando el módulo está acoplado a otro módulo componible Henn, para unirse a dos 15mm piezas. Si se utiliza por separado, el uso de unión no es necesario.

The union (S) should be used only when this module is coupled to another Module Henn, to join two pieces of 15mm. If it is used separately, the use of the union is not necessary.