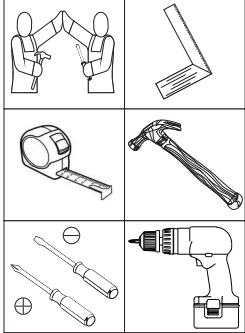
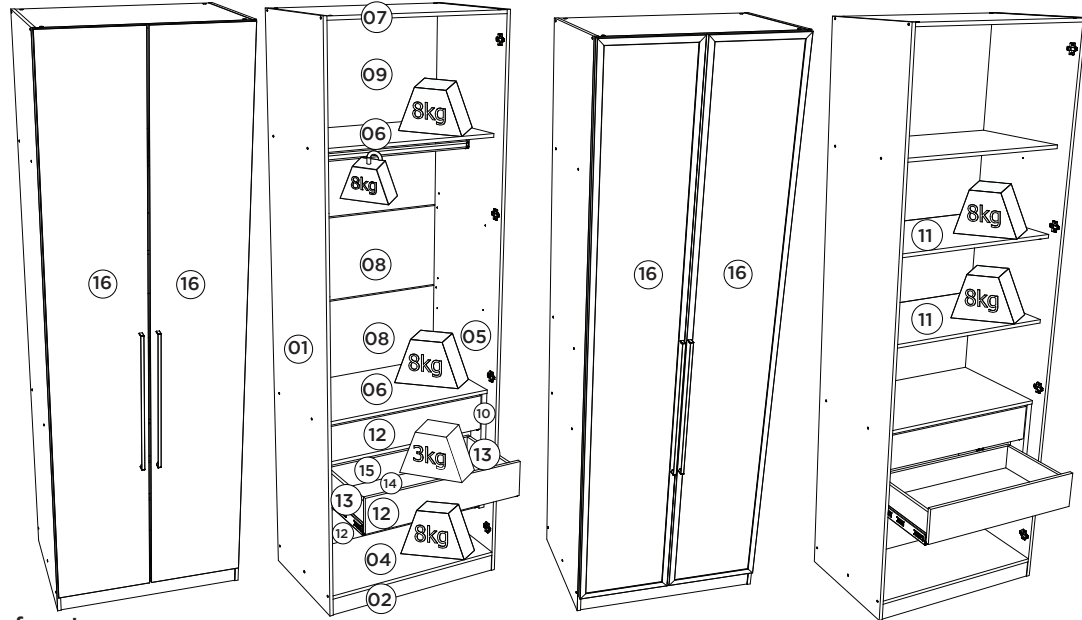

Roupeiro 02 Portas 03 Gavetas Seletto
Armario 02 Puertas 03 Cajones Seletto
Wardrobe 02 Doors 03 Drawers Seletto
Referência/Cor

- c MC03-133 - Areia HP
- c MC03-184 - Areia HP/Jequitibá
- c MC04-133 - Areia HP
- c MC04-184 - Areia HP/Jequitibá

Requisitos para montagem
Requisitor para la montaje
Assembly Requirements

 Imagens meramente ilustrativas
 Imágenes meramente ilustrativas
 Images for illustration only

 Opção 1
 Opción 1
 Option 1

 Opção 2
 Opción 2
 Option 2

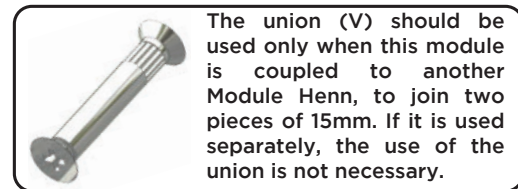
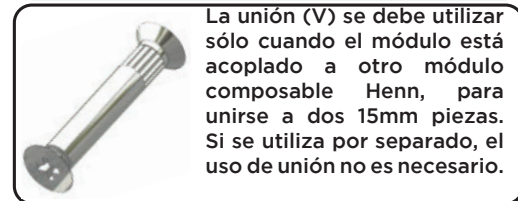
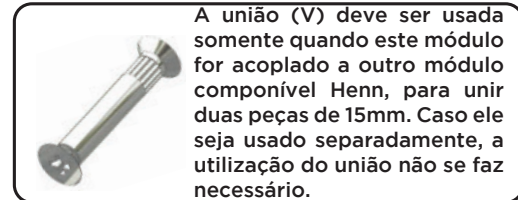
Lista de Peças | Lista de piezas | List of parts

Item	Caixa Caja Box	Qtd Ctd Qty	Descrição Descripción Description	Medidas (mm) Dimensiones (mm) Size (measurements) (mm)
01	1/3	01	Lateral esquerda Lateral izquierda Left side	2400x520x15
02	2/3	01	Rodapé frontal Pie delantero Front baseboard	770x73x15
03	2/3	01	Rodapé traseiro Pie trasero Rear baseboard	770x73x15
04=07	2/3	01	Base Tampo Base Tapa Base and Top	770x520x15
05	1/3	01	Lateral direita Lateral derecha Right side	2400x520x15
06	2/3	02	Prateleira Estante Shelf	770x450x15
07=04	2/3	01	Base Tampo Base Tapa Base and Top	770x520x15
08	1/3	05	Fundo Fondo Bottom	790x365x3
09	1/3	01	Fundo Superior Fondo superior Superior background	790x489x3
10	1/3	02	Ripa lateral Listón lateral Ripa side	530x80x25
11	2/3	02	Prateleira Móvel Estante móvil Mobile Shelf	770x450x15
12	2/3	03	Frente de gaveta Frente de cajón Front of drawer	712x152x15
13	2/3	06	Lado de gaveta Lado del cajón Side of drawer	350x122x15
14	2/3	03	Fundo de gaveta Recortado Fondo de cajón recortado Drawer bottom trimmed	676x361x3
15	2/3	03	Ripa de trás Malla detrás Rear lath	695x122x15
16	3/3	02	Porta Puerta Dorr	2320x391x15
16	3/3	02	Porta Espelho Puerta de espejo Mirror Door	2320x391x20

 Pesos máximos recomendados com carga uniformemente distribuídas.
 Peso máximo recomendado con la carga distribuida uniformemente.
 Recommended maximum weights with evenly distributed.

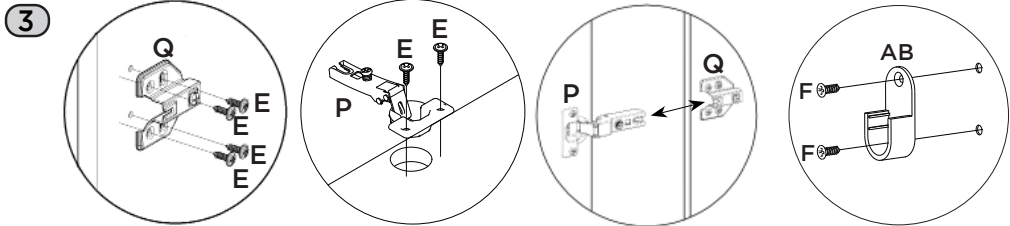
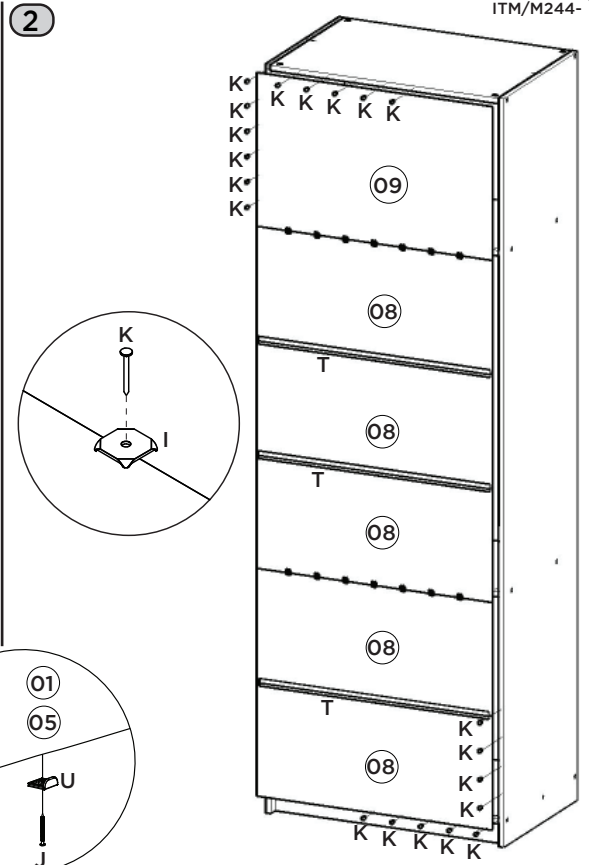
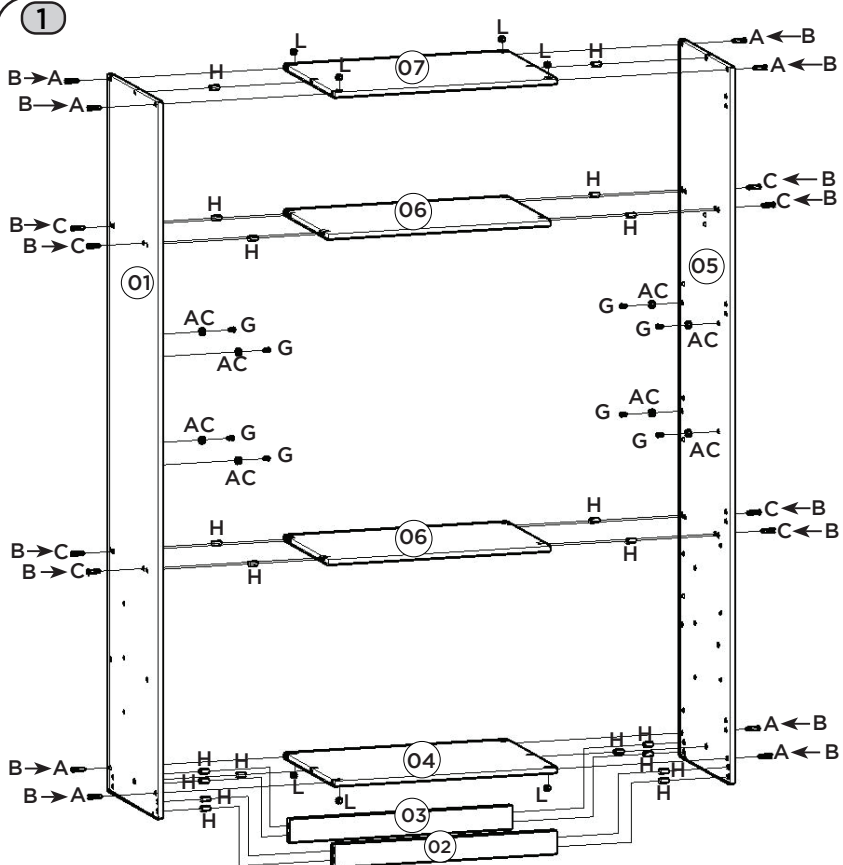
Ferragens | Herrajes | Hardware

A 08x Parafuso 4,5x50mm CHT. Tornillo 4,5x50mm CHT. Screw 4,5x50mm CHT.	B 38x Adesivo tapa parafuso 10mm Adhesivo tapón de tornillo 10mm Bolt cover adhesive 10mm	C 08x Parafuso 3,5x40mm CHT. Tornillo 3,5x40mm CHT. Screw 3,5x40mm CHT.	D 04x Parafuso 3,5x22mm CHT. Tornillo 3,5x22mm CHT. Screw 3,5x22mm CHT.	E 54x Parafuso 3,5x14mm FLA. Tornillo 3,5x14mm FLA. Screw 3,5x14mm FLA.	F 46x Parafuso 3,5x12mm CHT. Tornillo 3,5x12mm CHT. Screw 3,5x12mm CHT.	G 14x Parafuso 3,0x16mm CHT. Tornillo 3,0x16mm CHT. Screw 3,0x16mm CHT.	H 44x Cavilha 8x25mm Cinta 8x25mm Dowel 8x25mm
I 14x Fixador de fundos Fijador de fondos Bottom fixer	J 04x Prego 12x12mm Anelado Clavo 12x12mm Anillado Ringed Nails 12x12mm	K 74x Prego 10x10mm Clavo 10x10mm Nail 10x10mm	L 08x Porca cilíndrica Tuerca cilíndrica Cylindrical nut	M 06x Cantoneira plástica Cantoneira plástica Plastic angle brackets	N 06x Cantoneira suporte triangular Cantoneira soporte triangular Triangle support angle	O 06x Distanciador de corrediça Distanciador de deslizamiento Sliding spacer	P 08x Dobradiça SlideOn Alta Amort. 35mm Bisagra SlideOn Alta Amort. 35mm Hinge SlideOn High damper 35mm
Q 08x Calço Removível Calzado extraíble Removable Shim	R 03x Corrediça telescópica Diapositivas telescópicas Telescopic slides	S 02x Puxador Aleno Fit 593mm Tirador Aleno Fit 593mm Handle Aleno Fit 593mm	T 03x Perfil "I" 777mm Perfil "I" 777mm Profile "I" 777mm	U 04x Sapata "L" 16x20mm Zapata "L" 16x20mm "L" shoe 16x20mm	V 05x Parafuso União Metal Tornillo Unión Metal Metal Union Screw	W 01x Etiqueta resinada Henn Etiqueta resinada Henn Henn resin label	X 01x Sachê de cola Bolsa de pegamento Glue bag
Y 06x Parafuso 4,0x35mm CHT. Tornillo 4,0x35mm CHT. Screw 4,0x35mm CHT.	Z 06x Parafuso 3,0x30mm CHT. Tornillo 3,0x30mm CHT. Screw 3,0x30mm CHT.	AA 01x Cabideiro Alum. 762mm Alum. 762mm percha Alum. coat hanger 762mm	AB 02x Suporte cabideiro Soporte de percha Coat hanger support	AC 08x Suporte Prateleira 15x9 Soporte Estantería 15x9 Shelf Support 15x9	AD 04x Parafuso 3,5x25mm FLA. Tornillo 3,5x25mm FLA. Screw 3,5x25mm FLA.		



Observação: As ferragens que serão utilizadas nas portas, já acompanham o produto.

Nota: El hardware que se usará en las puertas, ya acompañar el producto.

Note: The hardware that will be used on the doors, already accompany the product.

Fazer furação passante para fixar os puxadores, utilizando as pré-marcas existentes nas portas.

Taladre agujeros para fijar las manijas, utilizando las marcas previas en las puertas.

Drill through holes to fix the handles, using the pre-markings on the doors.

