

HENN

Ind. e Com. de Móveis Henn
Mondai - SC - Brasil

+55 49 3674.3500

@moveishenn
www.henn.com.br

INSTRUÇÕES DE MONTAGEM

INSTRUCCIONES DE MONTAJE
ASSEMBLY INSTRUCTIONS

Roupeiro 2 Portas Deslizantes Seletto | Armario 2 Puertas Deslizadores Seletto | Wardrobe 2 Sliding Doors Seletto

c MC10-133 Areia HP

c MC10-184 Areia HP/Jequitibá

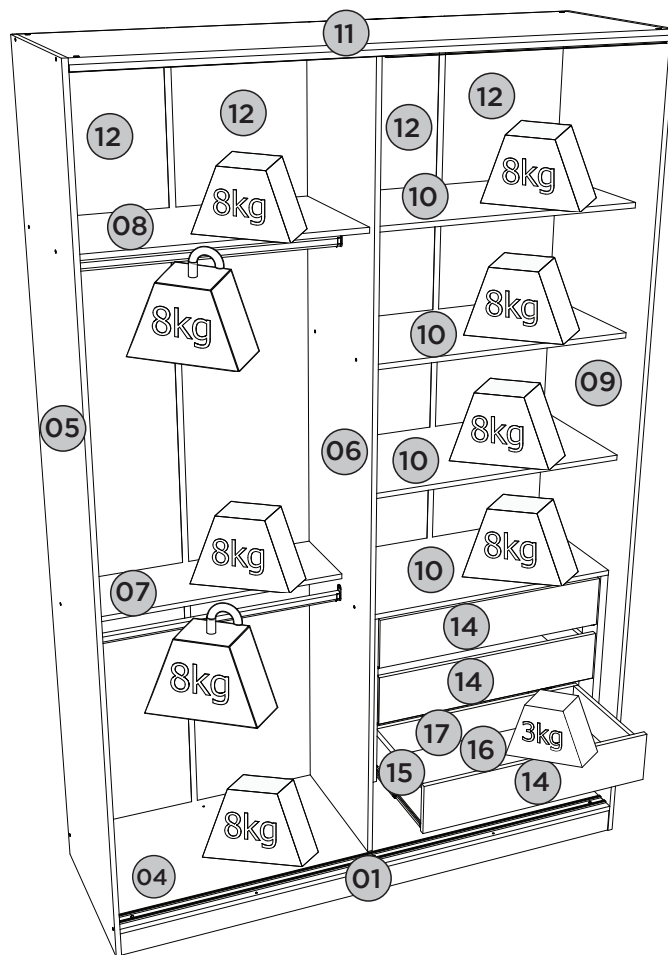
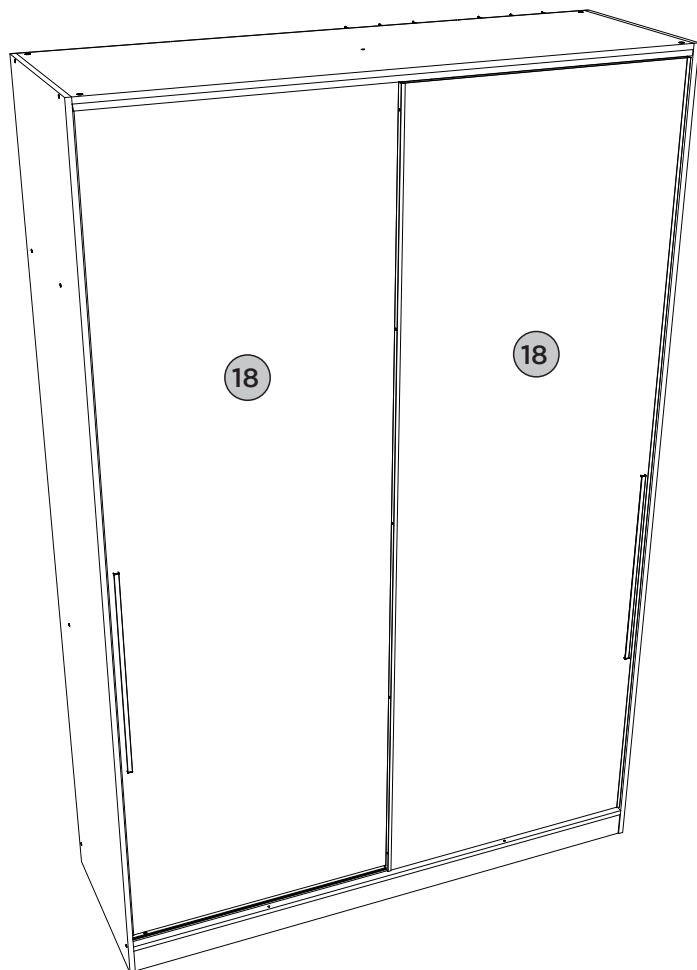

Pesos máximos recomendados com carga distribuída
Peso máximo recomendado con la carga distribuida
Recommended maximum weights with evenly distributed.

Requisitos para montagem Requisitor para la montaje Assembly Requirements

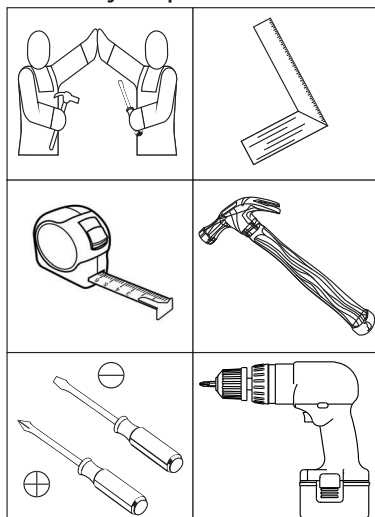

Imagens meramente ilustrativas
Imágenes meramente ilustrativas
Images for illustration only

AVISO

Para limpeza de seu móvel, use uma flanela seca ou umedecida, e não utilize produtos químicos que possam danificar seu produto.

SISTEMA DE MONTAGEM

O sistema de montagem dos produtos, funciona de acordo com a ordem crescente dos números indicados no desenho. Ex: 01, 02, 03, 04... até a conclusão da montagem.

ADVERTENCIA

Para limpieza de su móvil, use una flanela seca o húmeda, y no utilice productos químicos que puedan dañar su producto.

SISTEMA DE MONTAJE

El sistema de montaje de los productos funciona de acuerdo con el orden creciente de los números indicados en el dibujo. Ej.: 01, 02, 03, 04... hasta la conclusión del montaje.

NOTICE

To clean your furniture, use a dry or wet cloth, and do not use chemicals that may damage your product.

ASSEMBLY SYSTEM

The products' assembly system works according to the increasing order of the indicated numbers. For example: 01, 02, 03, 04 ... to the end of the assembly. 1

1

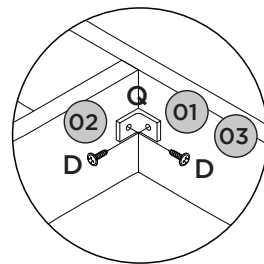
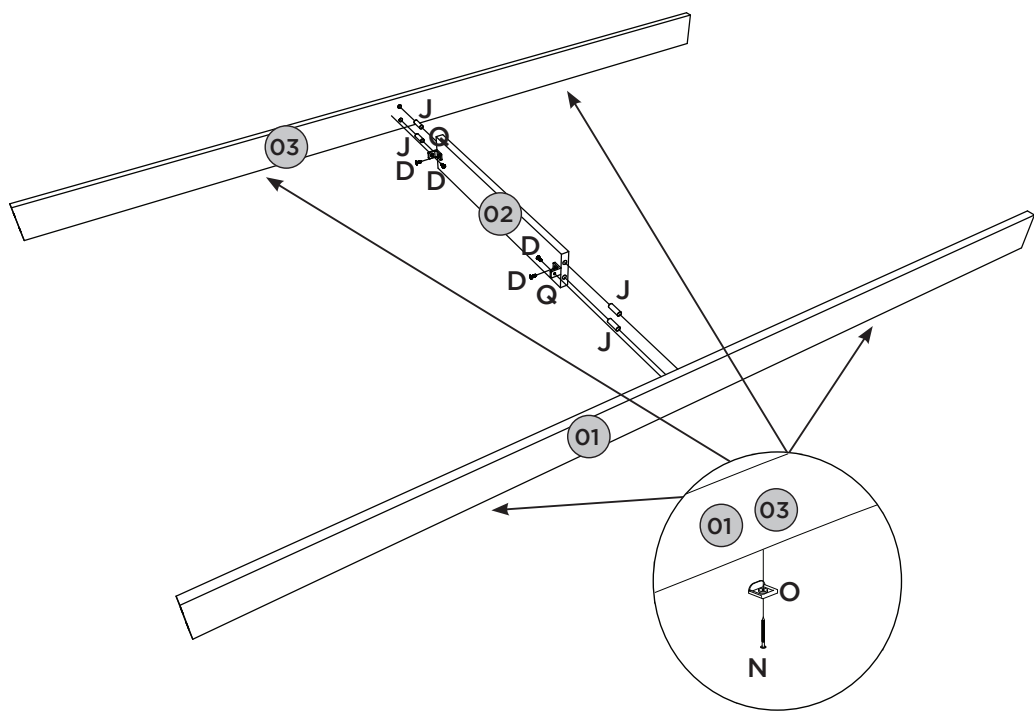

2

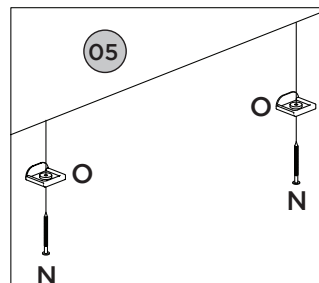
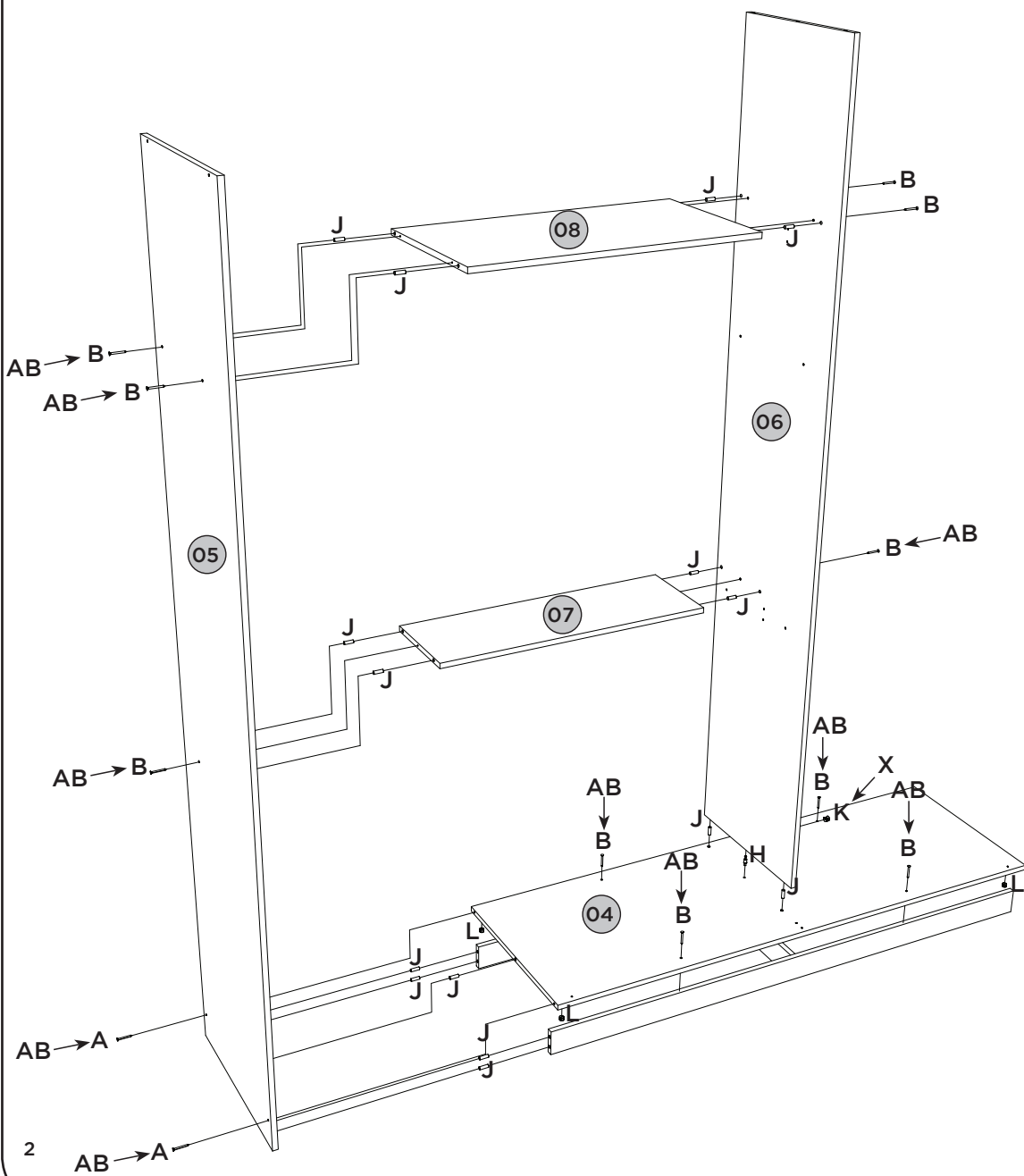

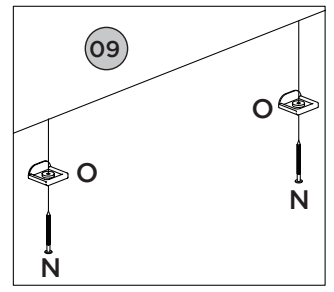
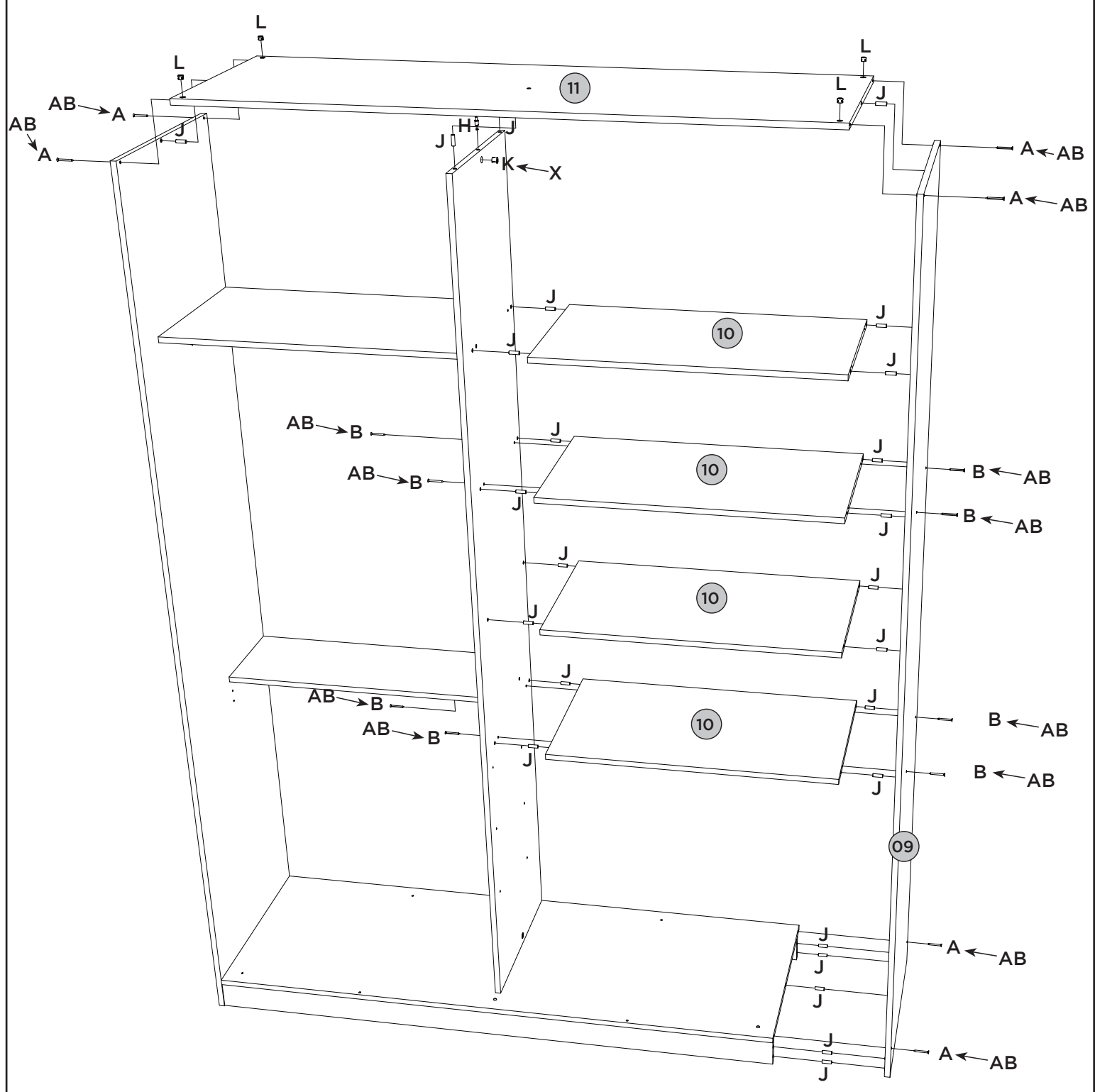

4 Fixar os pregos (M) a uma distância de 100mm de um para outro.

Fijar el clavo (M) a una distancia un 100mm a otro.

Fix the nails (M) at a distance of 100mm from one to another.

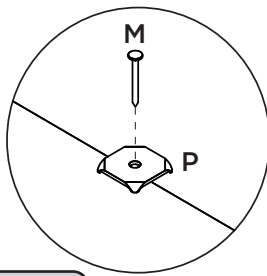

Os freios devem ser encostados a lateral.

Los frenos deben ser apoyados en el lateral.

The brakes should be against the side.

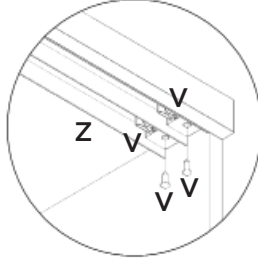
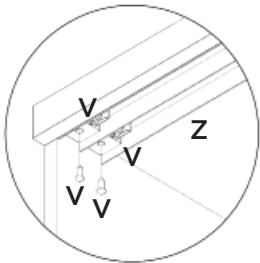

Colocação do freio esq. (V) deve ser colocado no espaço de trás do trilho superior (Z).

Colocação do freio dir. (V) deve ser colocado no espaço de frente do trilho superior (Z).

Colocación de frenos izq. (V) Debe ser colocado en espacio de nuevo carril superior (Z).

Colocación de frenos der. (V) Debe ser colocado en espacio de nuevo carril superior (Z).

Placing the left brake (V) should be placed in the rear space of the upper rail (Z).

Placing the right brake (V) should be placed in the front track of the upper track (Z).

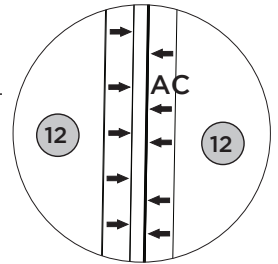
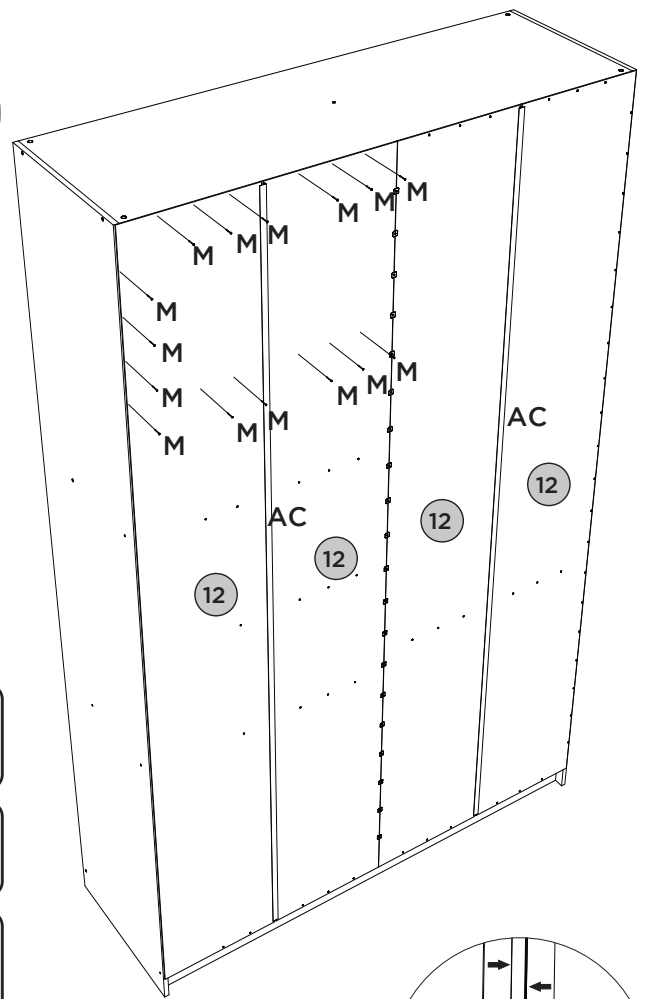

5

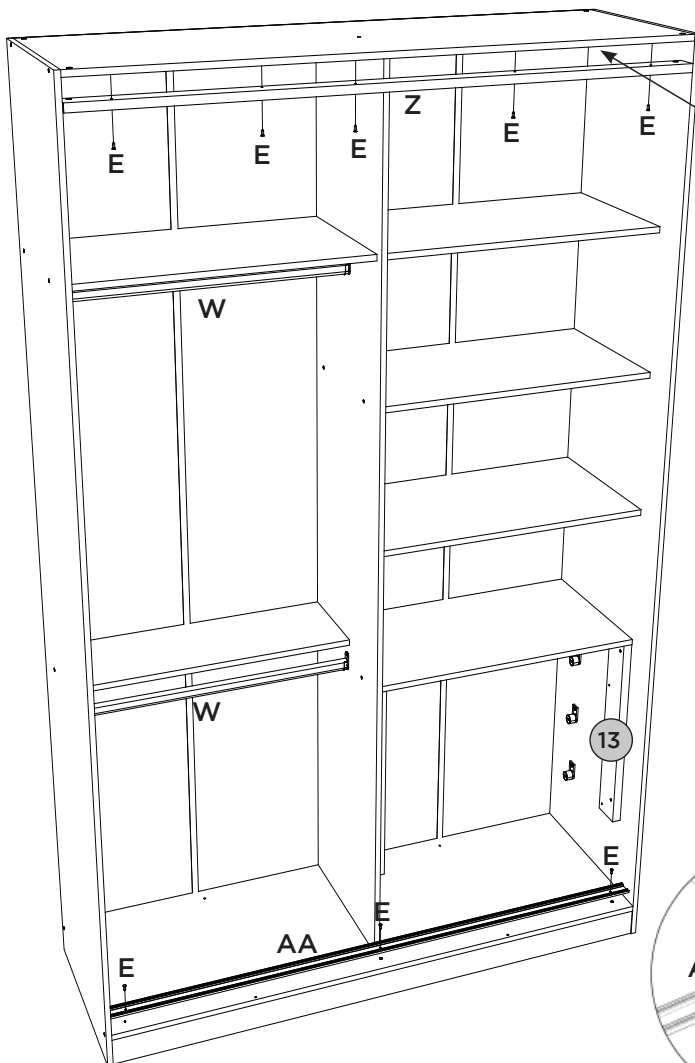

O trilho Superior (Z) deverá ser alinhado com a borda da frente do tampo (11).

El carril superior (Z) debe estar alineado con el borde frontal de la superficie de trabajo (11).

The Top Rail (Z) should be aligned with the front edge of the top (11).

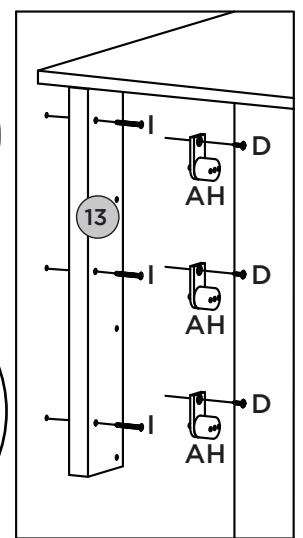
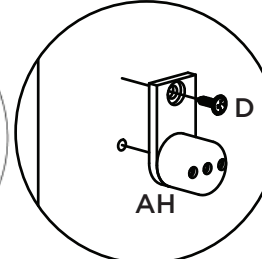
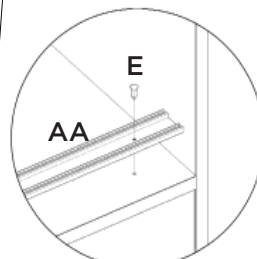
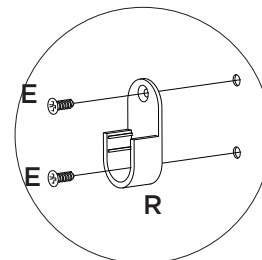

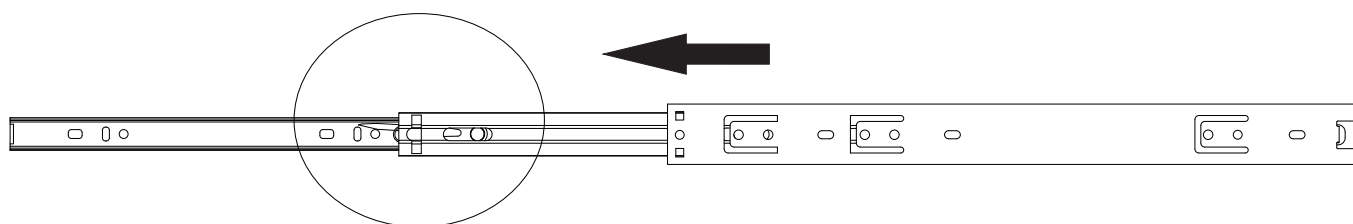
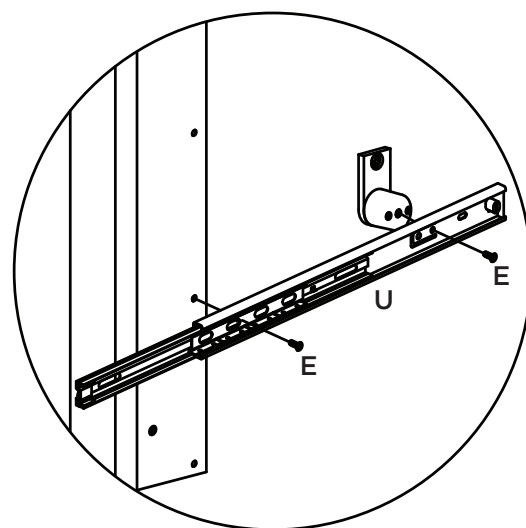
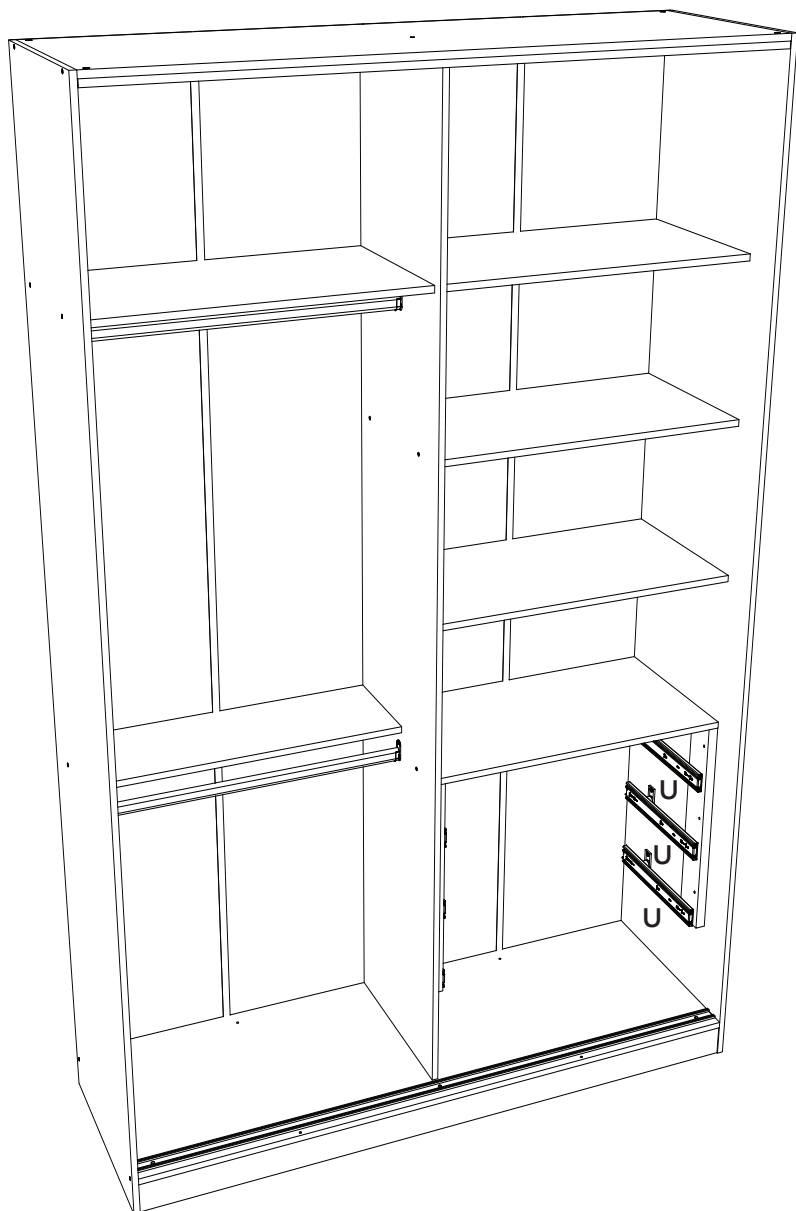

Para a desmontagem da corrediça siga a instrução ao lado.

Para el desmontaje seguimiento de diapositivas la instrucción siguiente a.

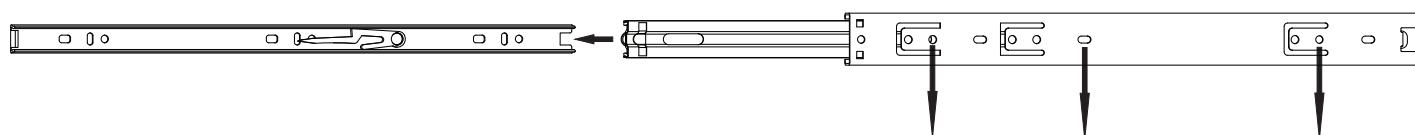
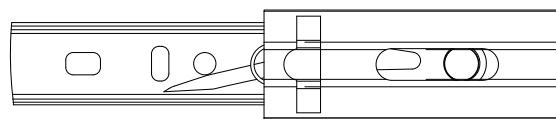
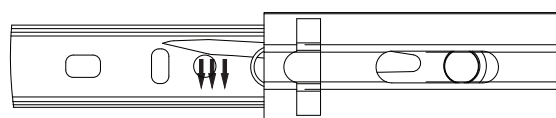

Fixar as corrediças nessas furações

Fijar las diapositivas de estos agujeros

Fazer furação passante para fixar os puxadores, utilizando as pré marcações existentes nas portas.

Taladre agujeros para fijar las manijas, utilizando las marcas previas en las puertas.

Drill through holes to fix the handles, using the pre-markings on the doors.

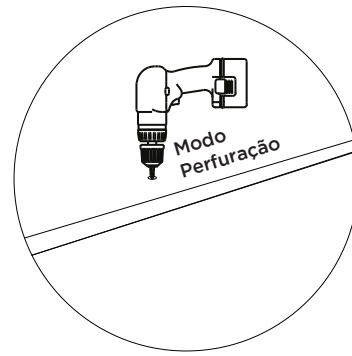

Porta 12mm
Puerta 12mm
Door 12mm

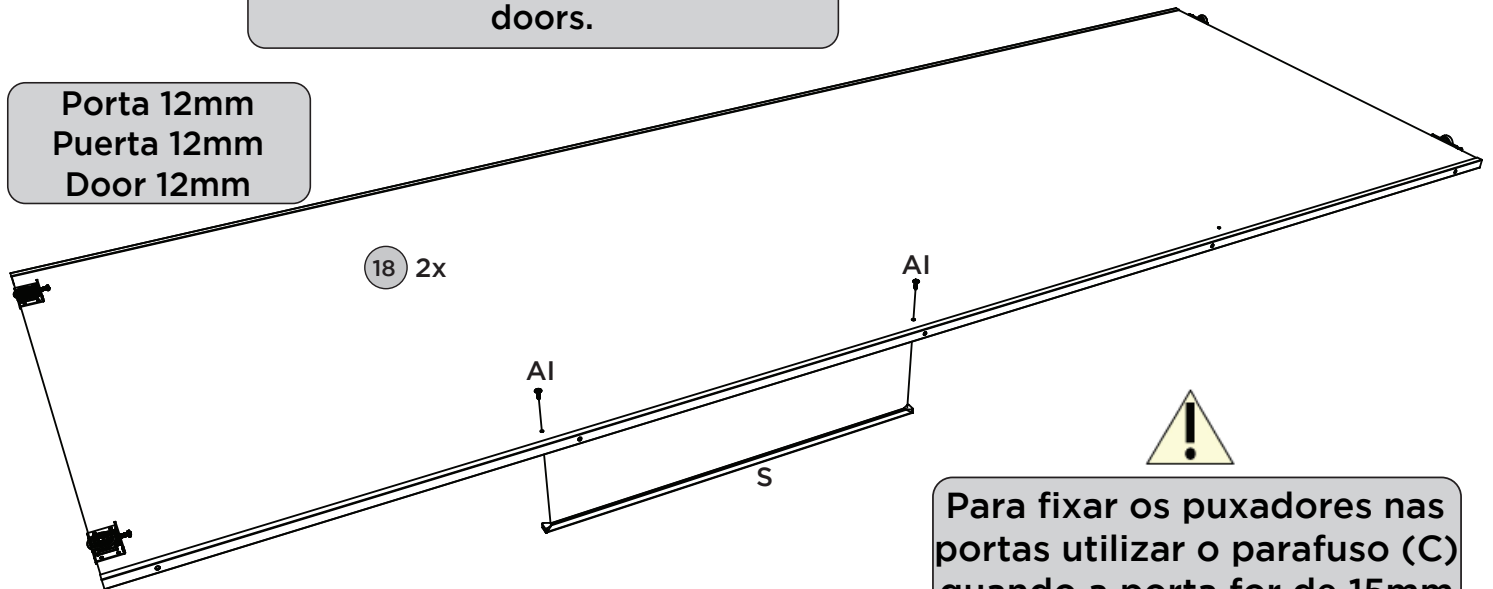

Para fixar os puxadores nas portas utilizar o parafuso (C) quando a porta for de 15mm e o parafuso (AI) quando a porta for de 12mm.

Para fijar las manijas en las puertas, utilice el tornillo (C) cuando la puerta sea de 15 mm y el tornillo (AI) cuando la puerta sea de 12 mm.

To fix the handles on the doors, use the screw (C) when the door is 15mm and the screw (AI) when the door is 12mm.

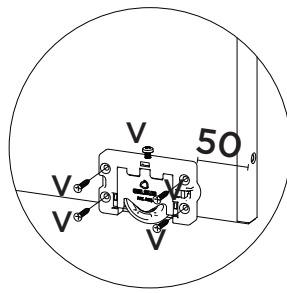
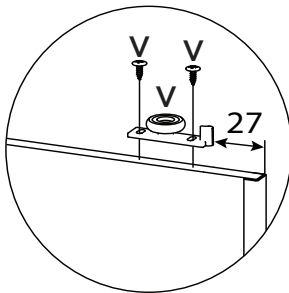

Porta 15mm
Puerta 15mm
Door 15mm

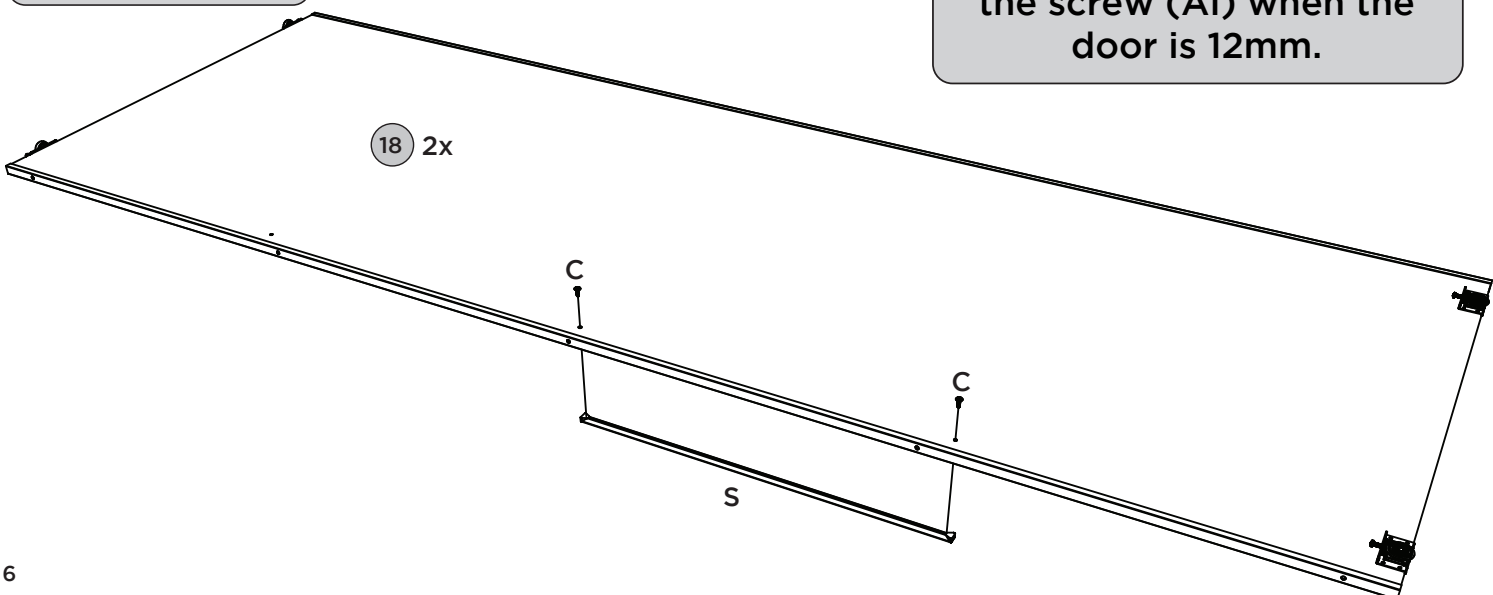

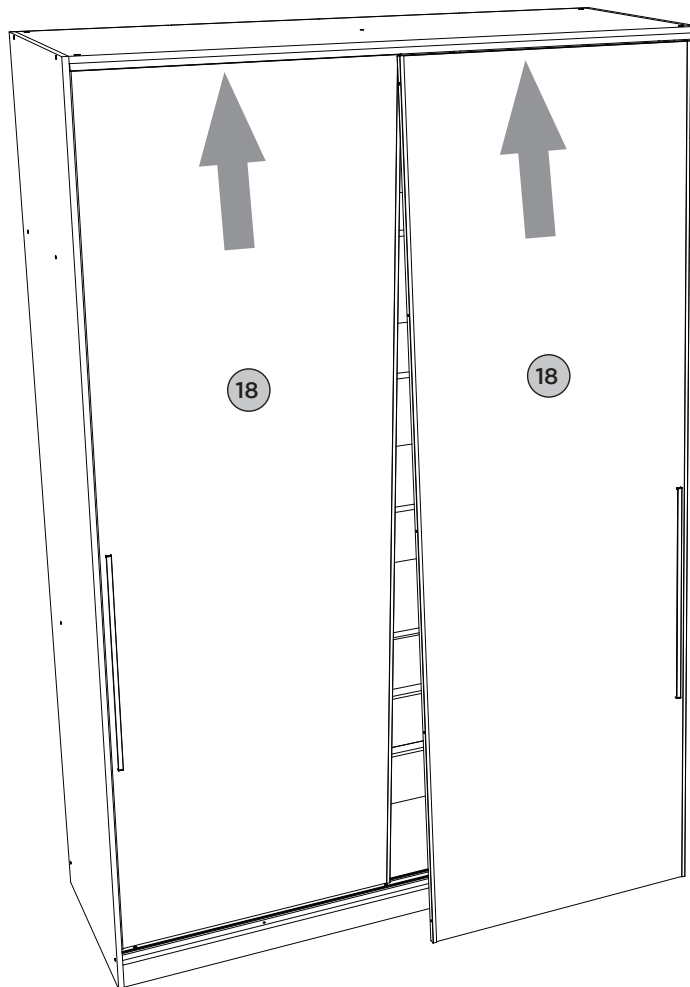

10 Montagem gaveta 3x. Montaje del cajón 3x. Mounting drawer 3x.

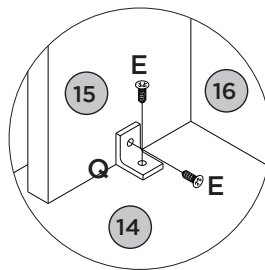
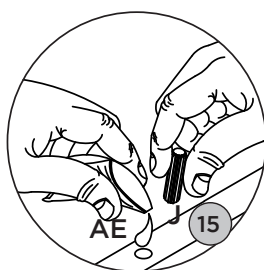
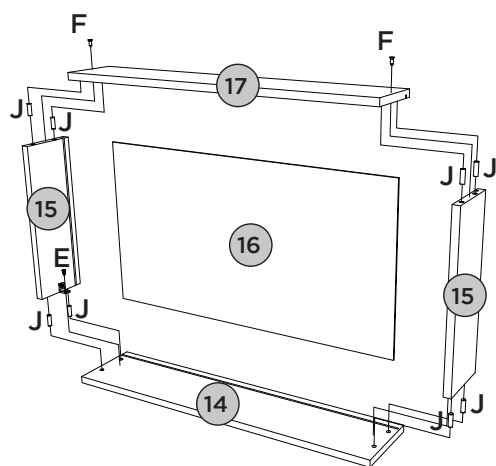

A corredeira (U) deverá ser alinhada com a parte de baixo do lado de gaveta (15)

La corredera (U) debe ser alineada con la parte de por el lado del cajón (15)

The slide (U) should be aligned with the underside of the drawer side (15)

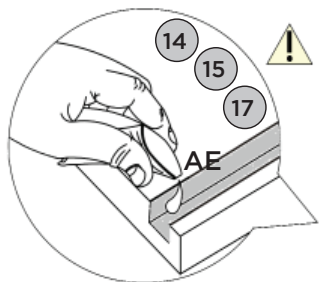

Utilizar o Sachê de cola (AE) nas cavilhas (J) e nos frisos das gavetas.

El uso de pegamento de paquetes (AE) sobre los pasadores (J) y las cuentas de los cajones.



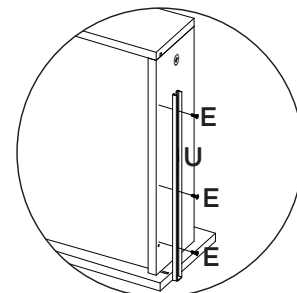
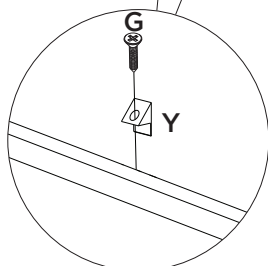
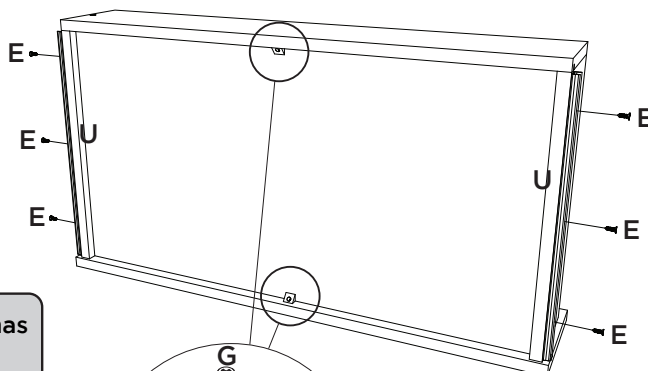











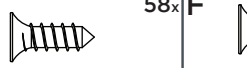

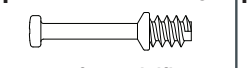



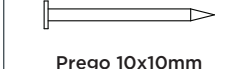





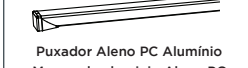
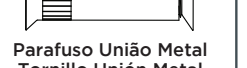

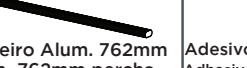

Use the glue sachet (AE) on the pegs (J) and on the frieze of the drawers.



Lista de Peças | Lista de piezas | List of parts

Item	Caixa Caja Box	Qtd Ctd Qty	Descrição Descripción Description	Medidas (mm) Dimensions (mm) Size (measurements) (mm)
01	1/3	01	Rodapé Frontal Rodapié Frontal Front baseboard	1555x73x15
02	1/3	01	Travessa do rodapé Carril pie Baseboard crosspiece	455x73x15
03	1/3	01	Rodapé Traseiro Rodapié trasero Rear baseboard	1555x73x15
04	1/3	01	Base Base Base	1555x520x15
05	2/3	01	Lateral esquerda Lateral izquierda Left side	2400x520x15
06	2/3	01	Divisão División Division	2297x450x15
07	1/3	01	Prateleira do varão Estantería hombre Rod shelf	770x250x15
08=10	1/3	01	Prateleira Estante Shelf	770x420x15
09	2/3	01	Lateral direita Lateral derecha Right side	2400x520x15
10=08	1/3	04	Prateleira Estante Shelf	770x420x15
11	1/3	01	Tampo Tapa Top	1555x520x15
12	2/3	04	Fundo Fondo Bottom	2327x391x3
13	1/3	02	Ripa lateral Lado ripa Lateral clamp	530x80x25
14	1/3	03	Frente de gaveta Frente de cajón Front of drawer	712x152x15
15	1/3	06	Lado de gaveta Lado del cajón Side of drawer	350x122x15
16	2/3	03	Fundo de gaveta recortado Fondo del cajón recortado Cropped drawer bottom	676x361x3
17	1/3	03	Ripa de trás Malla detrás Rear lath	695x122x15
18	3/3	02	Porta Deslizante Puerta corrediza Sliding door - Areia HP	2267x783x12
18	3/3	02	Porta Deslizante Puerta corrediza Sliding door - Jequitibá	2267x783x15

Ferragens | Herrajes | Hardware

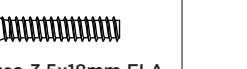
A  Parafuso 4,5x50mm CHT. Tornillo 4,5x50mm CHT. Screw 4,5x50mm CHT.	08x	B  Parafuso 3,5x40mm CHT. Tornillo 3,5x40mm CHT. Screw 3,5x40mm CHT.	18x	C  Parafuso 3,5x20mm FLA. Tornillo 3,5x20mm FLA. Screw 3,5x20mm FLA.	04x	D  Parafuso 3,5x14mm FLA. Tornillo 3,5x14mm FLA. Screw 3,5x14mm FLA.	10x	E  Parafuso 3,5x12mm CHT. Tornillo 3,5x12mm CHT. Screw 3,5x12mm CHT.	58x	F  Parafuso 3,0x30mm CHT. Tornillo 3,0x30mm CHT. Screw 3,0x30mm CHT.	06x
G  Parafuso 3,0x16mm CHT. Tornillo 3,0x16mm CHT. Screw 3,0x16mm CHT.	06x	H  Parafuso minifix Tornillo minifix Minifix bolt	02x	I  Parafuso 4,0x35mm CHT. Tornillo 4,0x35mm CHT. Screw 4,0x35mm CHT.	06x	J  Cavilha 8x25mm Cinta 8x25mm Dowel 8x25mm	68x	K  Tambor minifix Tambor minifix Minifix drum	02x	L  Porca cilíndrica Tuerca cilíndrica Cylindrical nut	08x
M  Prego 10x10mm Clavo 10x10mm Nail 10x10mm	128x	N  Prego 12x12mm Anelado Clavo 12x12mm Anillado Ringed Nails 12x12mm	06x	O  Sapata "L" 16x20mm Zapata "L" 16x20mm "L" shoe 16x20mm	06x	P  Fixador de fundos Fijador de fondos Bottom fixer	22x	Q  Cantoneira plástica Cantonera plástica Plastic angle brackets	08x	R  Suporte cabideiro Soporte de percha Coat hanger support	04x
S  Puxador Aleno PC Alumínio Mango de alumínio Aleno PC Aleno PC Aluminum Handle	02x	T  Parafuso União Metal Tornillo Unión Metal Metal Union Screw	05x	U  Corrediça telescópica Corredera telescópica Telescopic slide	03x	V  Kit Rodizio CM 110 Silence com Rolamento 2Pis Kit Ruedas CM 110 Silence con Cojinete 2Pis Caster Kit CM 110 Silence with Bearing 2Pis	01x	W  Cabideiro Alum. 762mm Alum. 762mm percha Alum. coat hanger 762mm	02x	X  Adesivo tapa parafuso 17mm Adhesivo tapón de tornillo 17mm Bolt cover adhesive 17mm	02x
Y  Cantoneira suporte triangular Cantonera soporte triangular Triangle support angle	06x	Z  Trilho Superior 1553mm Carril superior 1553mm Top Rail 1553mm	01x	AA  Trilho Inferior 1553mm Carril Inferior 1553mm Lower Rail 1553mm	01x	AB  Adesivo tapa parafuso 10mm Adhesivo tapón de tornillo 10mm Bolt cover adhesive 10mm	49x	AC  Perfil H 2312mm Perfil H 2312mm H profile 2312mm	02x	AD  Etiqueta resinada Henn Etiqueta resinada Henn Henn resin label	01x
AE  Sachê de cola Bolsa de pegamento Glue bag	02x	AF  Giz de correção Tiza de corrección Chalk of correction	02x	AG  Perfil Anti-empeno 2299mm Perfil anti-empeno 2299mm Anti-warp profile U 2299mm	04x	AH  Distanciador de corrediça Distanciador de deslizamiento Sliding spacer	06x	AI  Parafuso 3,5x18mm FLA. Tornillo 3,5x18mm FLA. Screw 3,5x18mm FLA.	04x		

A ferragem "AG" só será usada em caso de pedido de assistência técnica, pois o perfil antiempeno "U" já vem montado nas portas de fábrica.

El hardware "AG" sólo se utilizará en caso de solicitud de asistencia técnica, ya que el perfil antiempeno "U" ya viene montado en las puertas de fábrica.

The "AG" hardware will only be used in the event of a service request, as the "U" anti-pilling profile is already installed on the factory doors.

A união (T) deve ser usada somente quando este módulo for acoplado a outro módulo componível Henn, para unir duas peças de 15mm. Caso ele seja usado separadamente, a utilização do união não se faz necessário.

La unión (T) se debe utilizar sólo cuando el módulo está acoplado a otro módulo componible Henn, para unirse a dos 15mm piezas. Si se utiliza por separado, el uso de unión no es necesario.

The union (T) should be used only when this module is coupled to another Module Henn, to join two pieces of 15mm. If it is used separately, the use of the union is not necessary.