

# BL - 3300











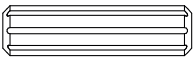

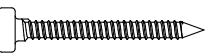
## Instruções de Montagem Assembly Instructions Instrucciones de Montaje

Acesse Vídeos de Montagens  
Access Mounting Videos  
Acceder a los Vídeos de Montaje  
[www.tecnomobili.ind.br](http://www.tecnomobili.ind.br)

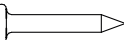
**tecnomobili**

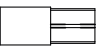
Estrada RSC 453, Km s/n° | Garibaldi | RS  
CEP: 95720-000 | Fone / Fax: 54.3464.2050  
sac@moveisvideira.com.br

REF	DESCRIÇÃO	QTD
A	 Cavilha 8 x 30mm	04
B	 3,5 x 16mm CC	32
C	 3,5 x 30mm CP	02
D	 3,5 x 40mm CC	04
E	 34 x 7mm Parafuso Minifix	04
F	 15 x 12mm Tambor Minifix	04
G	 Dobradiça Alta Calço Nº 7	04
H	 22 x 3mm Prego 10x10	20
I	 40 x 20 x 21mm Puxador	02
J	 55 x 70 x 48mm Rodízio	04
L	 6 x 8mm Suporte Para Prateleira	06
M	 680mm Perfil I	01

### Lista de Peças / List of pieces / Lista de piezas

CÓD	DESCRIÇÃO	DESCRIPTION	DESCRIPCION	QTD	M. PRIMA	DIMENSÕES
01	Tampo	Top	Tapa	1	MDP 15mm	610 x 410 x 15
02	Base	Base	Base	1	MDP 15mm	610 x 410 x 15
03	Lateral Esquerda	Left Side	Lateral Izquierda	1	MDP 15mm	680 x 360 x 15
04	Lateral Direita	Right Side	Lateral Derecha	1	MDP 15mm	680 x 360 x 15
05	Prateleira	Shelf	Estante	1	MDP 15mm	578 x 250 x 15
06	Porta	Door	Puerta	2	MDP 15mm	672 x 291 x 15
07	Costa	Back	Revés	2	Chapa Dura 3mm	700 x 297 x 3

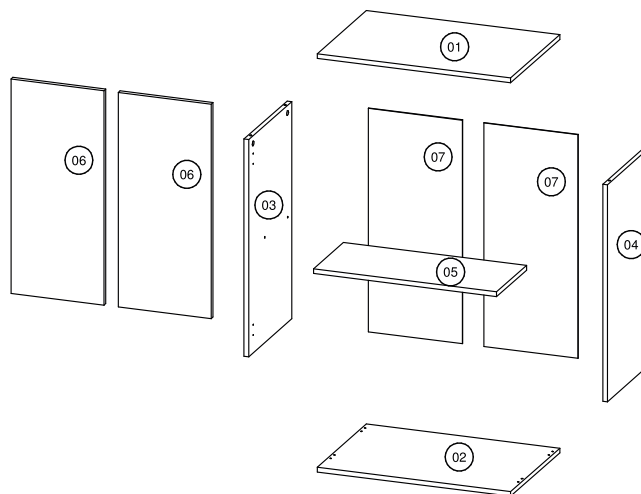

### Notas Especiais:

- 01 - Examine completamente todas as peças do móvel antes de começar o trabalho.
- 02 - Recomenda-se montar o móvel conforme este Manual de Montagem.
- 03 - É de responsabilidade do montador seguir as instruções do Manual de Montagem, que são fundamentais para garantir a estrutura do móvel.
- 04 - Para limpeza, utilizar somente pano úmido e sabão neutro.

### Special notes:

- 01 - Check all parts of the unit thoroughly before starting work.
- 02 - It is recommended to assemble the furniture according to this Installation Manual.
- 03 - It is the responsibility of the assembler to follow the instructions in the Assembly Manual, which are essential to ensure the structure of the furniture.
- 04 - For cleaning use only damp cloth and neutral soap.

### Notas especiales:

- 01 - Examine completamente todas las piezas del mueble antes de iniciar el trabajo.
- 02 - Se recomienda montar el mueble conforme el Manual de Ensamblaje.
- 03 - Es de responsabilidad del montador seguir las instrucciones del Manual de Ensamblaje, que son fundamentales para garantizar la estructura del mueble.
- 04 - Para limpieza solamente usar trapo húmedo y jabón neutro.

### Ferramentas | Tools | Herramientas

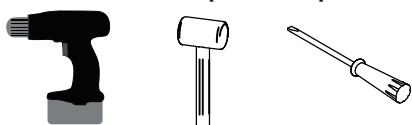

30 min.



Revisão: 11  
Data: 12/04/2018

Use the ruler below to measure the components

Measured in mm

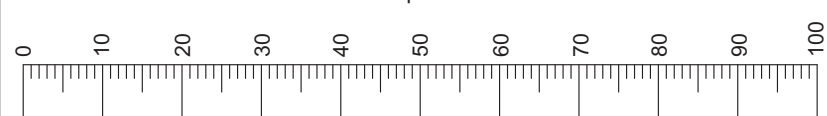

### Garante certificate:

The guarantee of products manufactured by Móveis Videira LTDA covers any defects / manufacturing defects, within the period established by the Consumer Protection Code, in its Article 26, II, which provides for a legal guarantee of ninety (90) days.

