

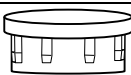

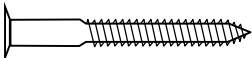







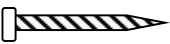

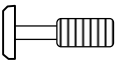
# ESQUEMA DE MONTAGEM – MESA CABECEIRA SEVILHA (01 vol)

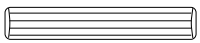

## INSTRUÇÃO DE MONTAGEM 1

RELAÇÃO DE FERRAGENS			
CÓD	DESENHO	QTD	NOME (ONDE USAR)
A		8	Ponteira 7/8" interna "Acabamento"
B		8	Paraf 4,5x50-Fixar as Laterais e as Gavetas.
C		8	Paraf 3,5 x 10 – Fixar as Corrediças
D		12	Paraf 4,0 x 25 – Fixar os Pés
E		15	Prego 8 x 8 – Pregar o Fundo
F		6	Parafuso mini-fixo – Unir Gavetas e Bases
G		6	Porca giro-fixo - Unir Gavetas e Bases
H		14	Cavilha 6x30 - Unir Gavetas e Bases
I		1	Arruela – Para Gaveta
J		1	Parafuso 3/16" x 5/8" – Para Gaveta
K		1	Espelho do Puxador – Para Gaveta
L		1	Puxador - Para Gaveta
M		1	Par de corrediça

RELAÇÃO DE PEÇAS DO CRIADO			
CÓDIGOS PEÇAS	QTD	NOME	DETALHES
1	1	TAMPO SUPERIOR	475 x 430 x 15 mm
2	1	TAMPO CENTAL (4 Furo passante)	475 x 430 x 15 mm
3	1	BASE (Sem Furo)	475 x 430 x 15 mm
4	1	LATERAL ESQUERDA	430 x 160 x 15 mm
5	1	LATERAL DIREITA	430 x 160 x 15 mm
6	1	FRENTE DA GAVETA	398 x 150 x 15 mm
7	1	LATERAL ESQUERDA DA GAVETA	350 x 100 x 15 mm
8	1	LATERAL DIREITA DA GAVETA	350 x 100 x 15 mm
9	1	CONTRA FUNDO	350 x 100 x 15 mm
10	1	FUNDO DA GAVETA	370 x 350 x 2.8 mm
11	1	FUNDO DO CRIADO	428 x 180 x 2.8 mm

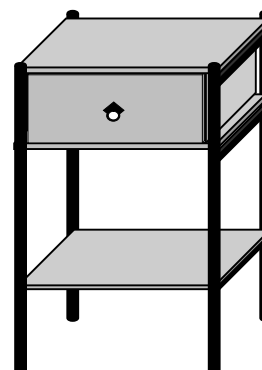

DIMENSÕES DO PRODUTO MONTADO: 615 X 480 X 470 MM



1 PESSOA



## INSTRUÇÃO DE MONTAGEM 2

## MONTANDO PASSO A PASSO

**1º PASSO:** COLOCAR AS CORREDIÇAS NAS LATERAIS DO CRIADO E PARAFUSAR O TAMPO.

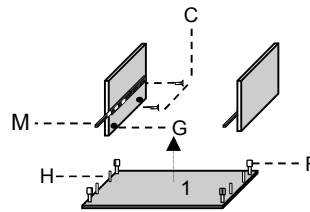
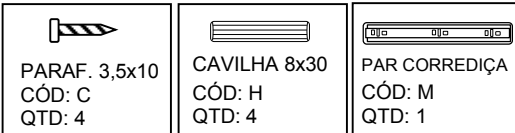
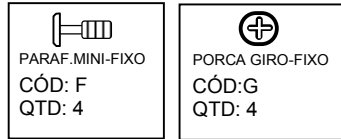

AS PEÇAS DO CRIADO SÃO PRÉ MARCADAS E PRÉ FURADAS PARA FACILITAR A MONTAGEM

AS PORCAS GIROFIX QUE UNEM A BASE SUPERIOR NÃO VÃO TAPA FURO DE ACABAMENTO, POIS AS GAVETAS TAMPAM

**2º PASSO:** VIRE O CRIADO PARA FIXAR A BASE  
OBS: CUIDADO PARA NÃO RISCAR O CRIADO

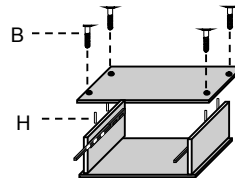
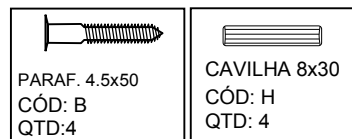

CUIDADO PARA NÃO RISCAR AS PEÇAS AO ENCAIXAR OS PARAFUSOS.

**3º PASSO:** COLOCAR PONTEIRAS DE ACABAMENTO E PARAFUSAR OS PÉS

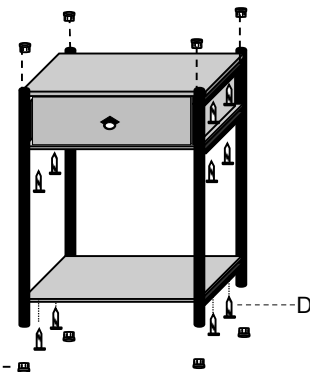
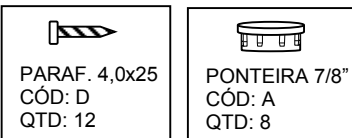

**4º PASSO:** MONTAGEM DA GAVETA.

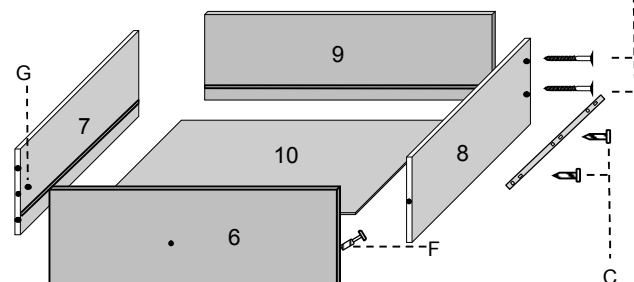
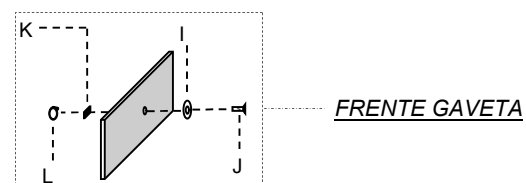
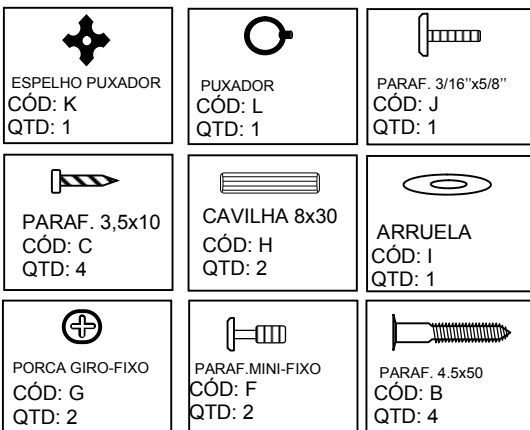

**IMPORTANTE:** PARA FACILITAR A MONTAGEM, FORRE O CHÃO COM O PAPELÃO DA EMBALAGEM, ASSIM PROTEGENDO AS PEÇAS PARA NÃO RISCAR