

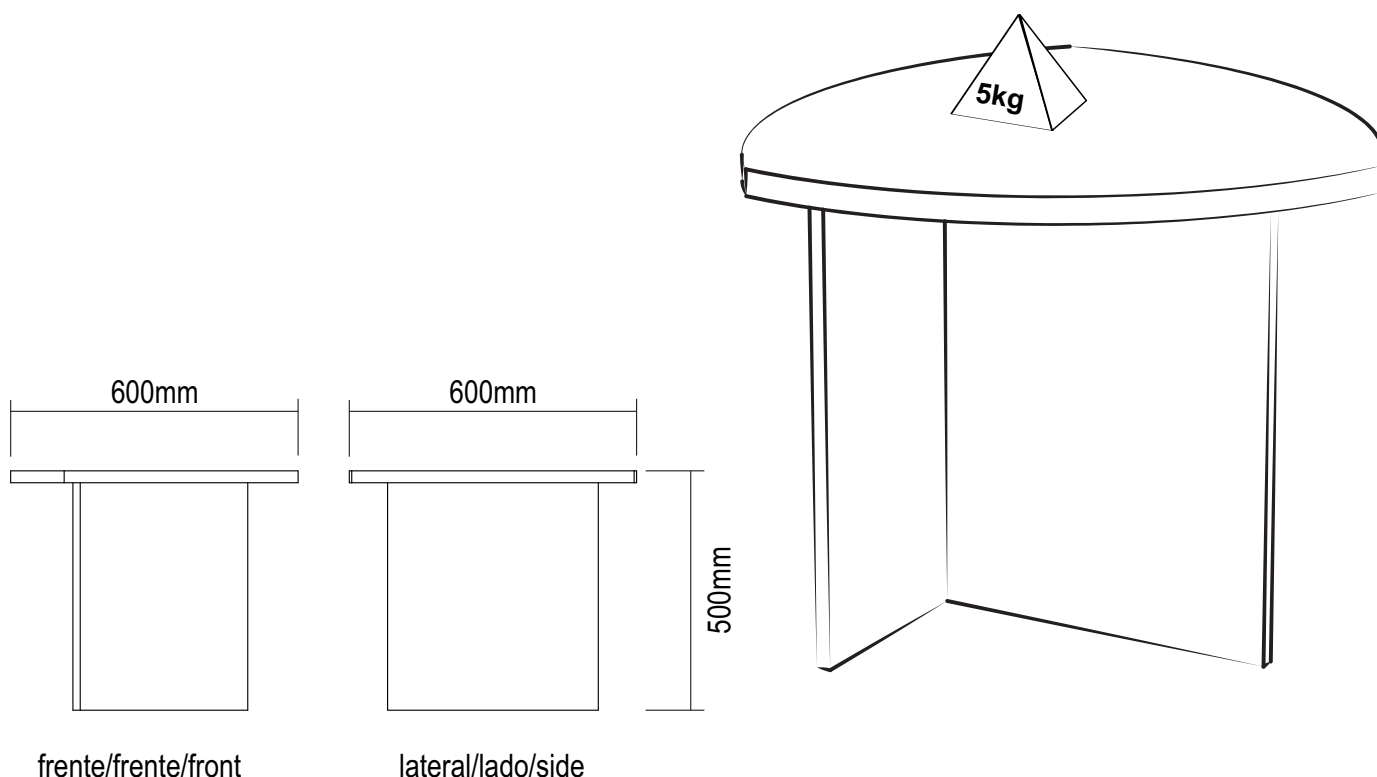

Mesa de Lateral Delta

Mesa Lateral Delta / Delta End Table

Versão 1.0 / Versión 1.0 / 1.0 Version



Conservação e Limpeza - Conservación y Limpieza - Conservation and Cleaning

Não expor o produto ao sol, altas temperaturas e umidade. Não arrastar objetos sobre a superfície do móvel (ex.: TV, DVD, aparelho de som, objetos decorativos...) e manter em local seco e arejado. Para a limpeza, utilizar um pano seco e macio. Não é necessário o uso de materiais abrasivos ou álcool.

No exponga el producto a la luz solar, las altas temperaturas y la humedad. No arrastre los objetos a través de la superficie de la unidad (por ejemplo, TV, DVD, equipo de música, objetos de decoración ...) Mantener en un lugar fresco y seco. Para la limpieza, utilizar un paño seco y suave. El uso de materiales abrasivos o del alcohol no es necesario.

Do not expose the product to sunlight, high temperatures and humidity. Do not drag objects across the surface of the unit (TV, DVD, stereo, decorative objects ...) keep it in a cool dry place. For cleaning, use a dry and soft cloth. Do not use abrasive materials or alcohol.

Garantia

Este certificado de Garantia é uma vantagem adicional oferecida ao consumidor, porém para que o mesmo tenha validade é imprescindível que seja apresentada a NOTA FISCAL de compra do produto.

Com este produto, a Artely tem como objetivo atender plenamente o proprietário-consumidor, proporcionando a garantia na forma aqui estabelecida, pelo período de três meses a partir da data da nota fiscal de compra. A Artely restringe a sua responsabilidade à substituição gratuita das peças defeituosas, em caso de defeitos ou avarias devidamente constatados como sendo de fabricação, durante a vigência desta garantia.

A Artely declara a garantia nula e sem efeito se o produto for alterado, adulterado, molhado ou consertado e ainda pela prática de montagem inadequada ou mau uso. Também será considerada nula em casos de força maior, como aqueles causados por agentes da Natureza (chuvas, incêndios, excesso de umidade, cupins,...) e eventos externos como objetos arrastados sobre a superfície do móvel (ex.: TV, DVD, aparelho de som, objetos decorativos...).

Para exercer seus direitos de comprador é importante que antes de montar seu produto você leia com atenção as instruções de cada passo do manual de montagem que acompanha o móvel.

Caso o produto não esteja em conformidade, entre em contato com a loja onde efetuou a compra e faça sua reclamação, apontando os defeitos técnicos observados. Para agilizar o seu atendimento, tenha sempre em mãos o manual de montagem com os respectivos números das peças defeituosas, conforme descritas no manual.

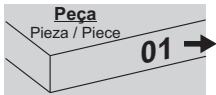

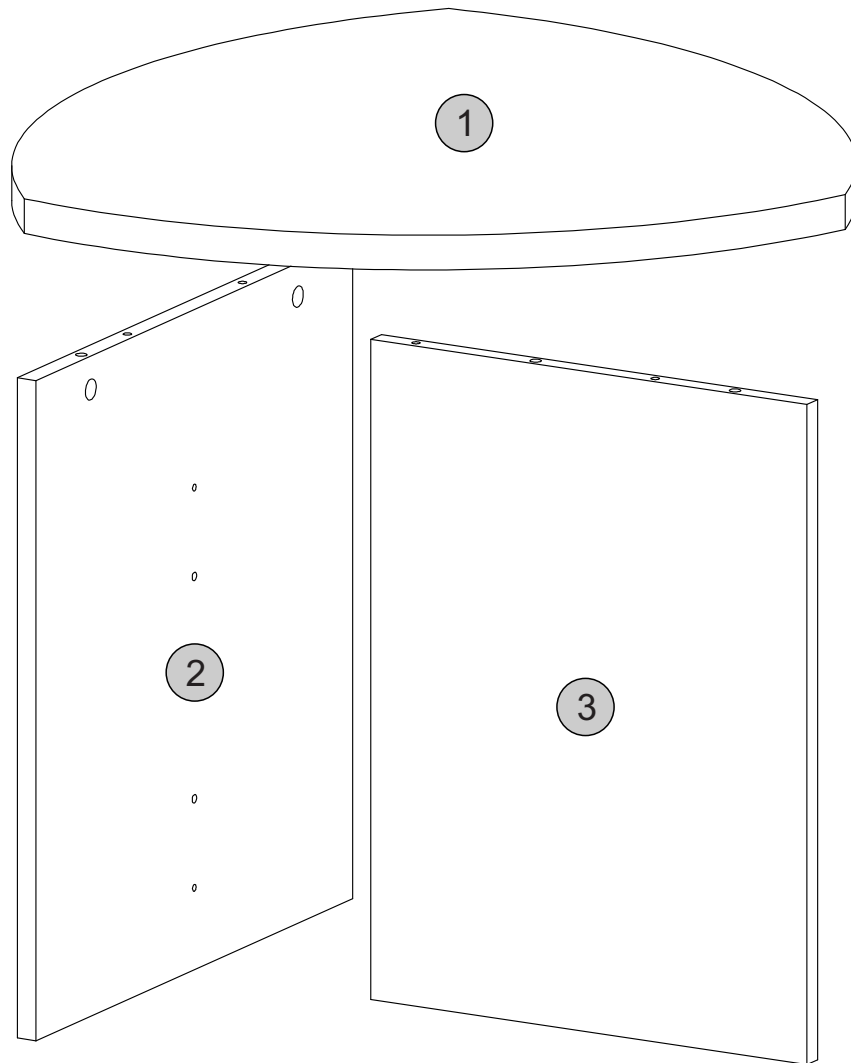
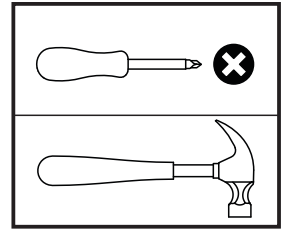

- O número na borda da peça corresponde ao manual.
- Para retirada do número usar Lustra-Móveis, Alcool em Gel ou Borracha.
- El número en el borde de la pieza coincide con el manual.
- Use una goma de borrar blanca, alcohol en gel o lustrador para muebles para eliminar los números.
- The number on the edge of the piece matches the manual.
- Use a White eraser, Alcohol Gel or Furniture Polish to remove the numbers.



Descrição	Descripción	Description	Qty
1-Tampo (600x600x25mm)	1-Tapa	1-Top	1
2-Lateral (475x440x15mm)	2-Lateral	2-Side	1
3-Divisão (475x350x15mm)	3-División	3-Division	1

Lista de Materiais

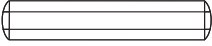
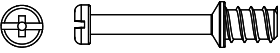
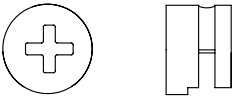
Lista de Materiales/ Hardware List

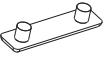
A		Cavilha / Tarugo / Dowel Ø6x30mm	06
B		Minifix / Minifix / Minifix Ø7x30mm	06
C		Tambor / Tambor / Minifix Cam Ø15x12mm	06
D		Tapa furo adesivo / Adhesivo / Hole Cover Ø18mm	06
E		Sapata / Pata / Foot	03

DICAS PARA FIXAR MINIFIX

TIP TO FASTEN THE MINIFIX
PISTA PARA ARREGLAR EL MINIFIX

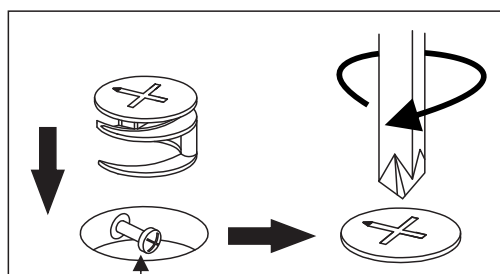

Cabeça do parafuso precisa estar no centro
La cabeza del tornillo debe estar en el centro
Screw head has to be in the center

Parafuso Minifix

Tornillo minifix/Minifix screw

Fixe o parafuso até o ressalto encostar na superfície da peça (veja o exemplo abaixo).

Tighten the screw until its overhang part lean on the piece surface (see the example below).

Fije el tornillo hasta que su parte sobresaliente toque la superficie de la pieza (vea el ejemplo abajo).

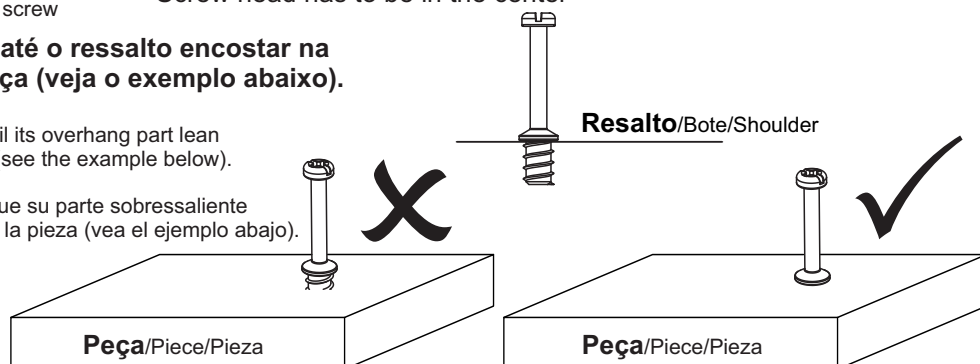

Passo 1

Paso/Step

PEÇA
Pieza/Piece

1 - TAMPO x1

FERRAGEM
Herraje/Hardware

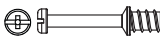
B  04

FERRAMENTA
Herramienta/Tool

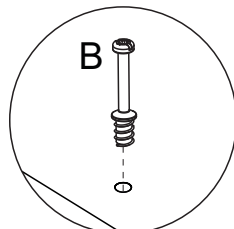
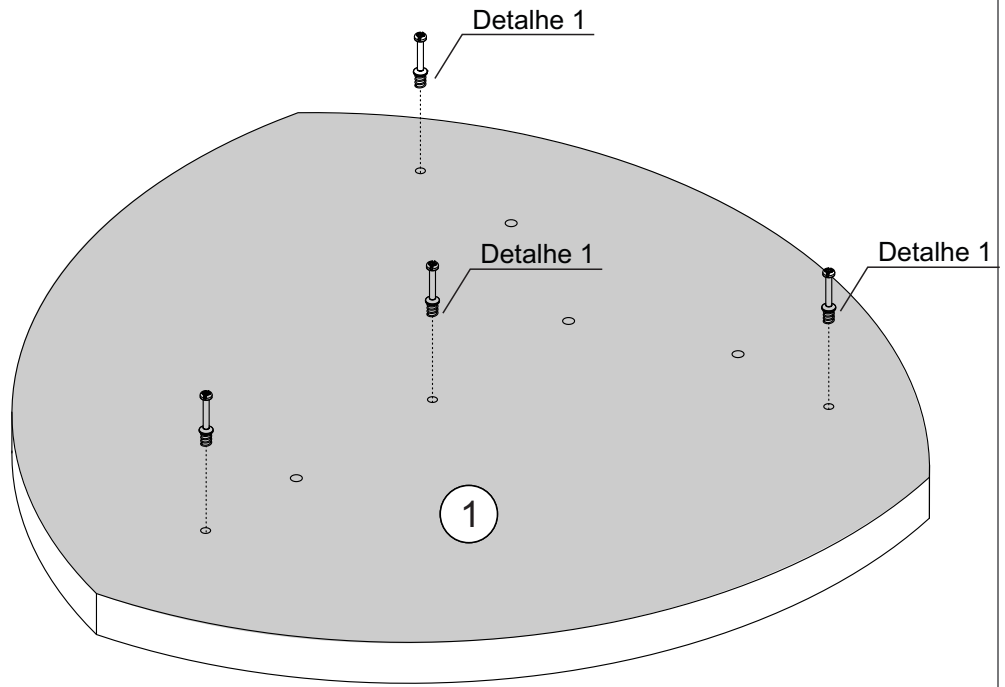
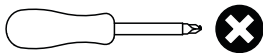

Detalhe 1
Detalle/Detail

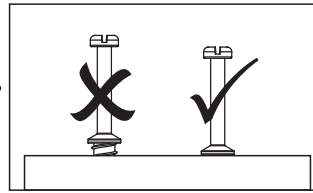

Passo 2

Paso/Step

PEÇA
Pieza/Piece

2 - LATERAL x1

FERRAGEM
Herraje/Hardware

A  02

B  02

E  02

FERRAMENTA
Herramienta/Tool

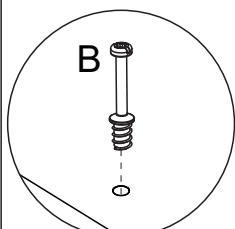
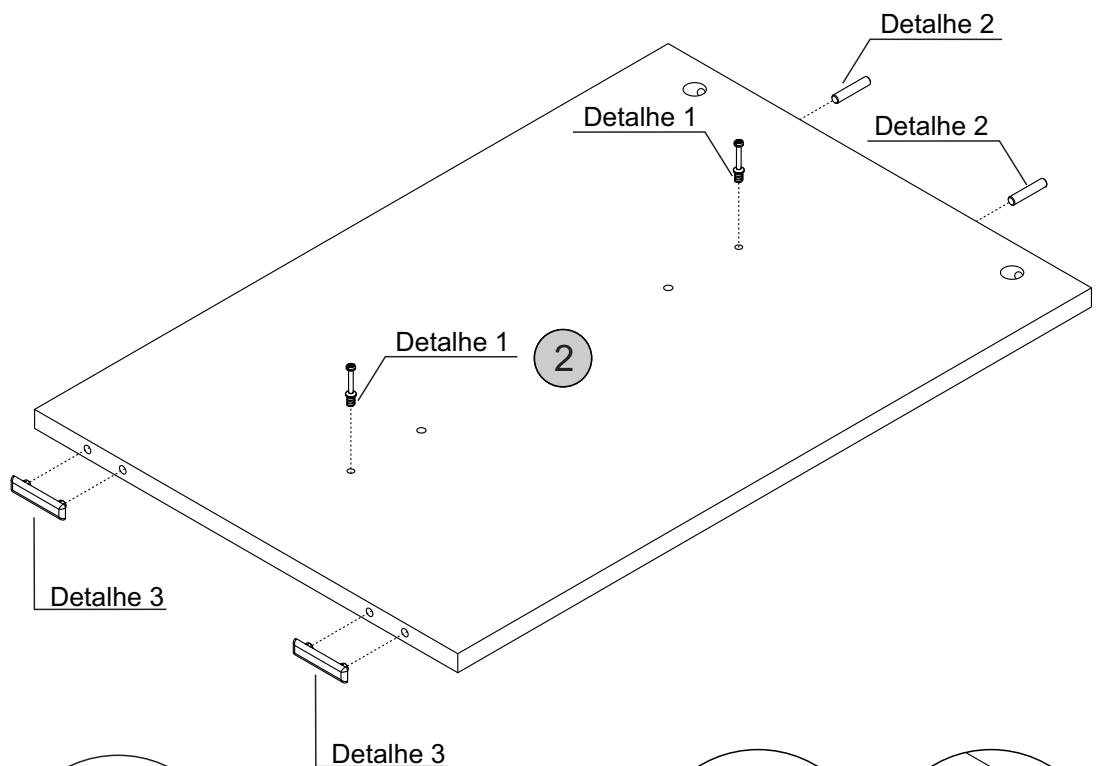
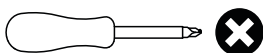
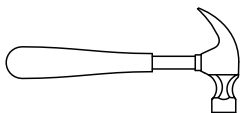

Detalhe 1
Detalle/Detail

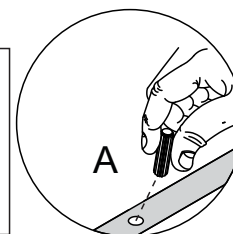
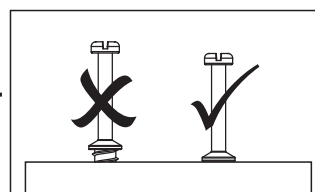

Detalhe 2
Detail/Detalle

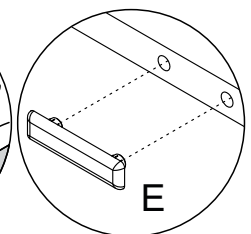

Detalhe 3
Detail/Detalle

Passo 3

Paso/Step

PEÇA
Pieza/Piece

3 - DIVISÃO x1

FERRAGEM
Herraje/Hardware

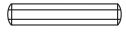
A  04

E  01

FERRAMENTA
Herramienta/Tool

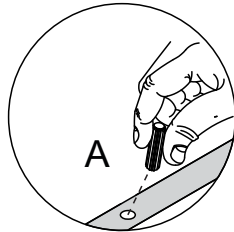
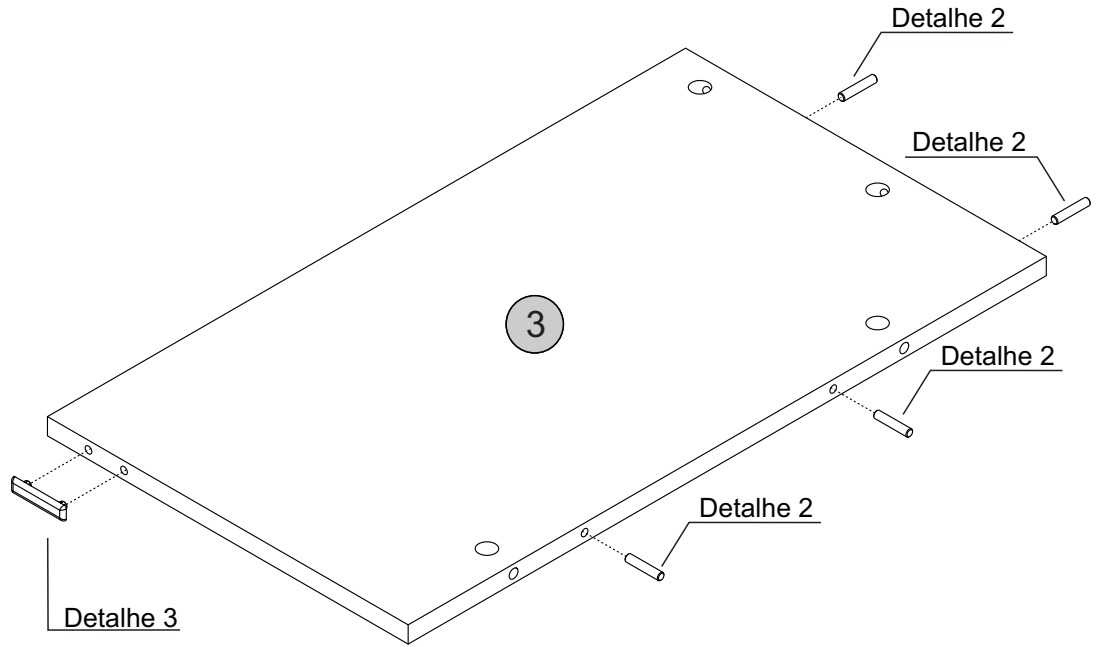
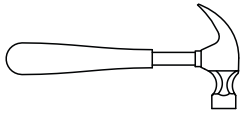

Detalhe 2
Detail/Detalle

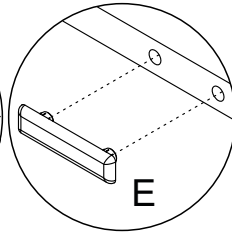

Detalhe 3
Detail/Detalle

Passo 4

Paso/Step

PEÇA
Pieza/Piece

2 - LATERAL x1

3 - DIVISÃO x1

FERRAGEM
Herraje/Hardware

C  02

D  02

FERRAMENTA
Herramienta/Tool

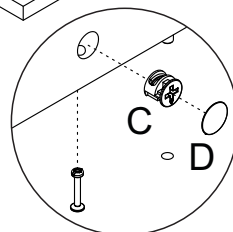
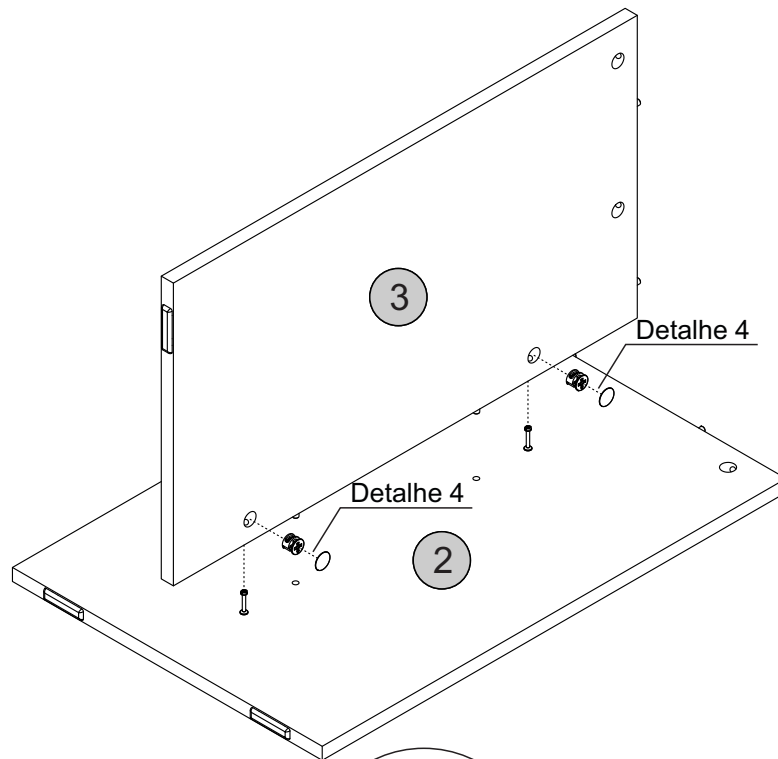
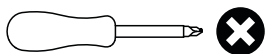

Detalhe 4
Detalle/Detail

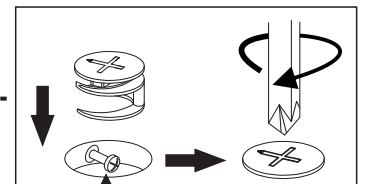

Cabeça do parafuso precisa estar no centro
La cabeza del tornillo debe estar en el centro
Screw head has to be in the center

Passo 5

Paso/Step

PEÇA
Pieza/Piece

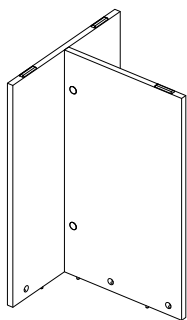

1 - TAMPO

x1

FERRAGEM
Herraje/Hardware

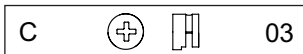

FERRAMENTA
Herramienta/Tool

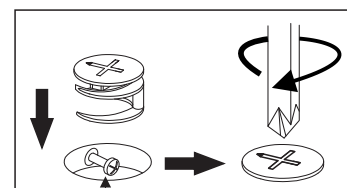
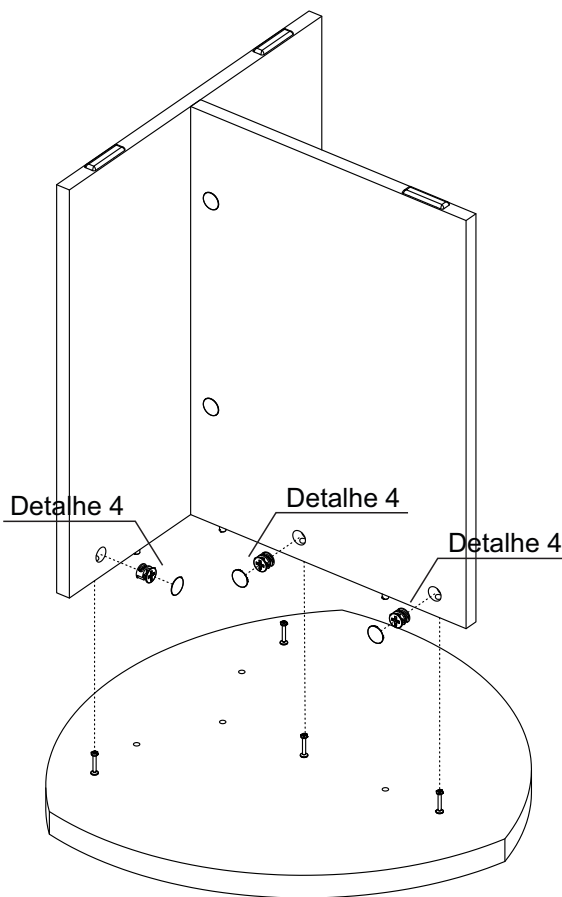
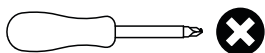

Cabeça do parafuso precisa estar no centro
La cabeza del tornillo debe estar en el centro
Screw head has to be in the center

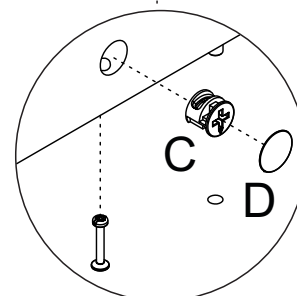

Detalhe 4
Detalle/Detail

Passo 6

Paso/Step

PEÇA
Pieza/Piece

FERRAGEM
Herraje/Hardware

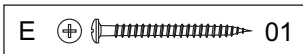

FERRAMENTA
Herramienta/Tool

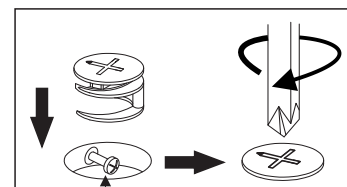
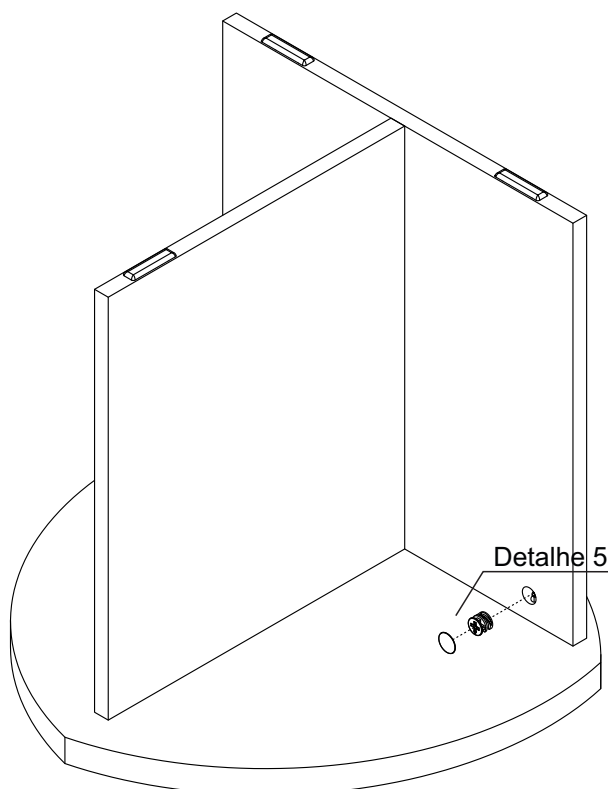
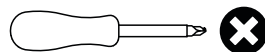

Cabeça do parafuso precisa estar no centro
La cabeza del tornillo debe estar en el centro
Screw head has to be in the center

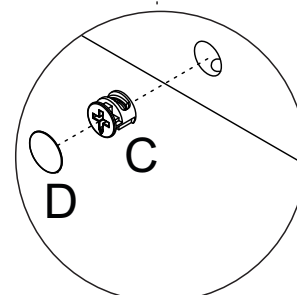

Detalhe 5
Detalle/Detail

Passo 7

Paso/Step

PEÇA
Pieza/Piece

FERRAGEM
Herraje/Hardware

FERRAMENTA
Herramienta/Tool

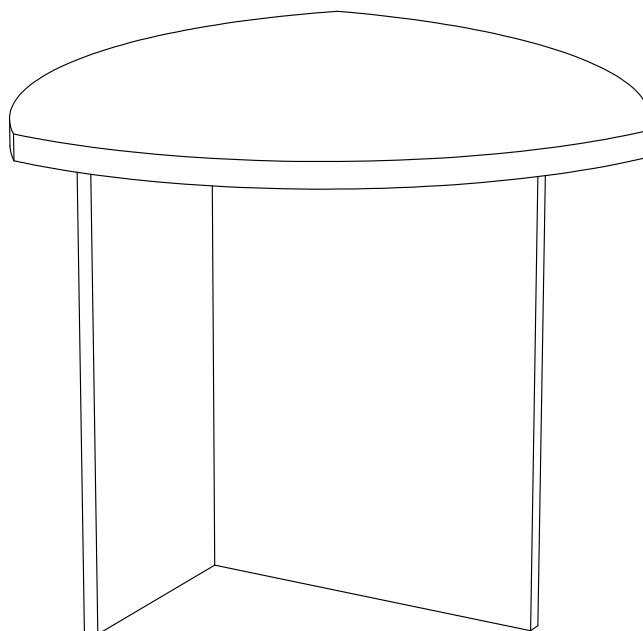

Parabéns, você montou seu móvel! Agora é só decorar sua casa e aproveitar!

Queremos ver como ficou o móvel Artely do seu jeito... Marque a gente com a #meuartely. Ficaremos felizes em compartilhar!

Ah, e se tiver qualquer dúvida, sugestão ou comentário, entra em contato com a gente pelo nosso site www.artely.com.br.

¡Congratulaciones, montaste tu mueble! ¡Ahora solo decora tu casa y disfruta!

Queremos ver este producto en tu hogar, a tu manera... Utilice #meuartely, ¡ficaremos encantados de compartir tu foto!

Si tienes alguna duda, sugerencia o comentario, contáctenos a través de nuestro sitio web www.artely.com.br.

Congratulations, you've assembled your new furniture! Decorate your home and enjoy!

We want to see how this product is in your home... Use #meuartely, we will be happy to share your picture!

If you have any doubt, suggestion or comment, get in touch with us through our website www.artely.com.br.