

**CÓDIGO DE PEÇAS**

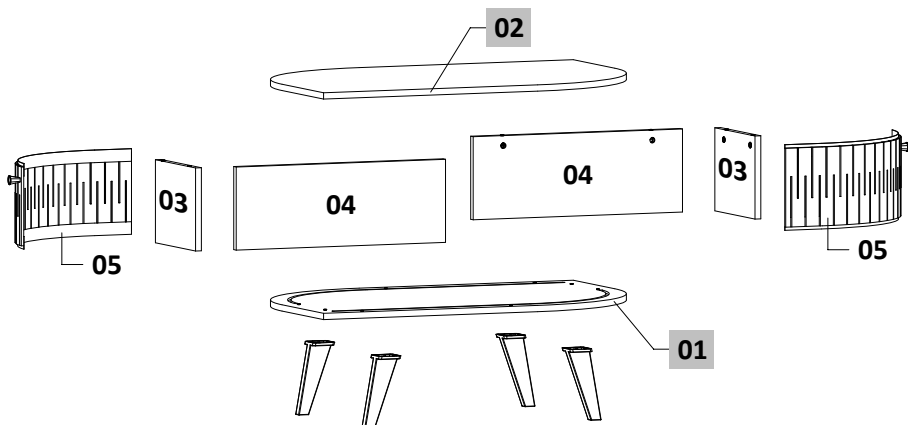

Edição: 11/08/2023

- Prepare a montagem do móvel próximo ao local que ele ficará definitivamente e evite deslocá-lo depois de montado;
- Forre o chão com papelão ou similar e utilize a isomanta que vem entre as peças para evitar o contato entre elas durante a montagem;
- Monte o móvel obedecendo a ordem numérica da **seqüência de montagem (S.M.)**, identificando as peças pelo **Código de peça (C.P.)** carimbado na mesma, de acordo com a tabela.

**Ferramentas necessárias para montagem (não fornecidas)**

*Tools required for assembly (not supplied)*

*Herramientas necesarias para el montaje (no suministradas)*



Parafusadeira / Screwdriver / Destornillador



Chave de Fenda e Phillips



Martelo / Hammer / Martillo

**Pessoas necessárias para montagem**

*People needed for assembly*

*Personas necesarias para el montaje*



1 pessoas / 1 people / 1 personas

**Tempo Montagem**

*Assembly time*

*Tiempo montaje*



60 min

- Prepare a montagem do móvel próximo ao local que ele ficará definitivamente e evite deslocá-lo depois de montado;
- Forre o chão com papelão ou similar e utilize a isomanta que vem entre as peças para evitar o contato entre elas durante a montagem;
- Monte o móvel obedecendo a ordem numérica da **seqüência de montagem (S.M.)**, identificando as peças pelo **Código de peça (C.P.)** carimbado na mesma, de acordo com a tabela.

**CUIDADOS ESPECIAIS**

**LIMPEZA:** Pano limpo umedecido em água e sabão neutro.

**BRILHO:** Flanela seca

Nº DA PEÇA	CÓDIGO DA PEÇA					PEÇAS (Descrição)	MATÉRIA PRIMA	DIMENSÕES (Dimensões em mm)	QUANT.
	NATURALE OFF WHITE	FENDI NATURALE	IMPERIAL SÉPIA	CALACATA OFF WHITE	JADE OLIVA				
01	203972.027	203972.029	203972.032	203972.033	203972.035	Base curvo	MDP	898 x 598 x 15	1
02	203973.027	203973.029	203973.034	203973.026	203973.036	Tampo curvo	MDP	898 x 598 x 15	1
03	203974.027	203974.029	203974.032	203974.033	203974.035	Lateral menor	MDP	224 x 198 x 15	2
04	203975.027	230975.029	203975.034	203975.026	203975.036	Lateral maior	MDP	540 x 198 x 15	2
05	203976.027	203976.029	203976.034	203976.026	203976.036	Porta	MDF	548 x 188 x 6	2

**LEGENDA DAS CORES**

009 - SEM PINTURA	026 - OFF WHITE	027- NATURALE	029 - FENDI	032 - IMPERIAL
033 - CALACATA	034 - SÉPIA	035 - JADE	036 - OLIVA	

**PESO SUPORTADO**



↑ 400 mm → 900mm ↖ 600 mm  
**Dimensão do Produto:**

# ACESSÓRIOS

## PARAFUSOS

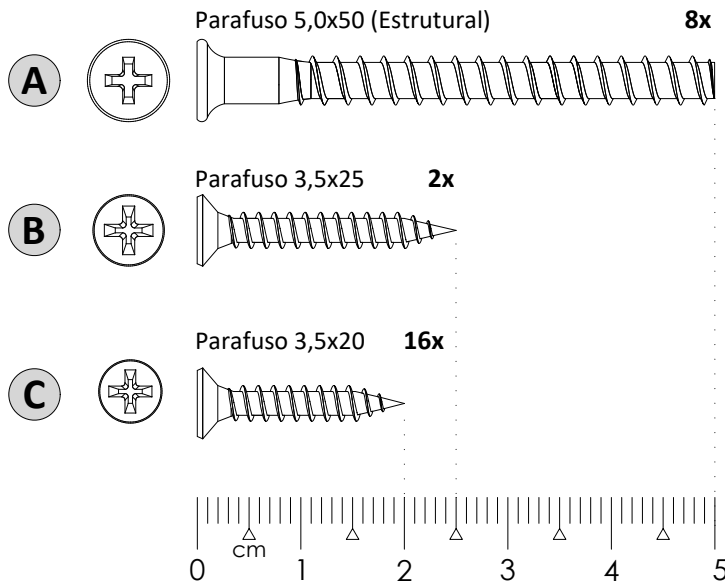

## CÓDIGO

1.02.10.0045

1.02.10.0004

1.02.10.0043

LETRA

DESCRIÇÃO

MATÉRIA PRIMA

QUANT.

CÓDIGO

D

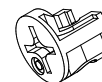

Castanha girofix  
12x10mm

Metal

8

1.02.05.0006

E

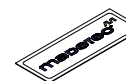

Etiqueta resinada

Plástico

1

1.02.08.0013

F

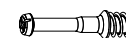

Pino girofix 5,0x30mm

Metal

8

1.02.05.0007

G

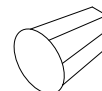

Puxador diamante

Plástico



2

1.02.02.0047

## RELAÇÃO DE COR DOS ACESSÓRIOS

LETRA	DESCRIÇÃO	MATÉRIA PRIMA	QUANTIDADE						CÓDIGO
			NATURALE OFF WHITE	FENDI NATURALE	IMPERIAL SÉPIA	CALACATA OFF WHITE	JADE OLIVA		
H	Tapa furo adesivo 18mm Off White	Papel				8		1.02.08.0216	
	Tapa furo adesivo 18mm Naturale		8					1.02.08.0219	
	Tapa furo adesivo 18mm Sépia				8			1.02.08.0258	
	Tapa furo adesivo 18mm Fendi			8				1.02.08.0245	
	Tapa furo adesivo 18mm Oliva						8	1.02.08.0267	
i	Giz p/ correção Calacata /Off White	Cera	1				1	1.02.14.0008	
	Giz p/ correção Naturale		1	1				1.02.14.0009	
	Giz p/ correção Imperial / Sépia				1			1.02.14.0018	
	Giz p/ correção Fendi			1				1.02.14.0011	
	Giz p/ correção Jade / Oliva						1	1.02.14.0021	
J	Trilho flexível 4/8 950mm Off White	Plástico				2		1.02.07.0640	
	Trilho flexível 4/8 950mm Naturale		2					1.02.07.0634	
	Trilho flexível 4/8 950mm Jade/Oliva						2	1.02.07.0639	
	Trilho flexível 4/8 950mm Imperial				2			1.02.07.0638	
	Trilho flexível 4/8 950mm Fendi			2				1.02.07.0641	
K	Sapata Retro Sigplast Naturale	Plástico	4					1.02.11.0033	
	Sapata Retro Sigplast Fendi			4				1.02.11.0025	
	Sapata Retro Sigplast Sépia/Chocolate				4			1.02.11.0026	
	Sapata Retro Sigplast Off White					4		1.02.11.0016	
	Sapata Retro Sigplast Oliva						4	1.02.11.0029	

### 1º PASSO

PEÇAS PIECES PIEZAS		<b>C</b>		16
		<b>K</b>		4

S.M.	C.P.
01	01

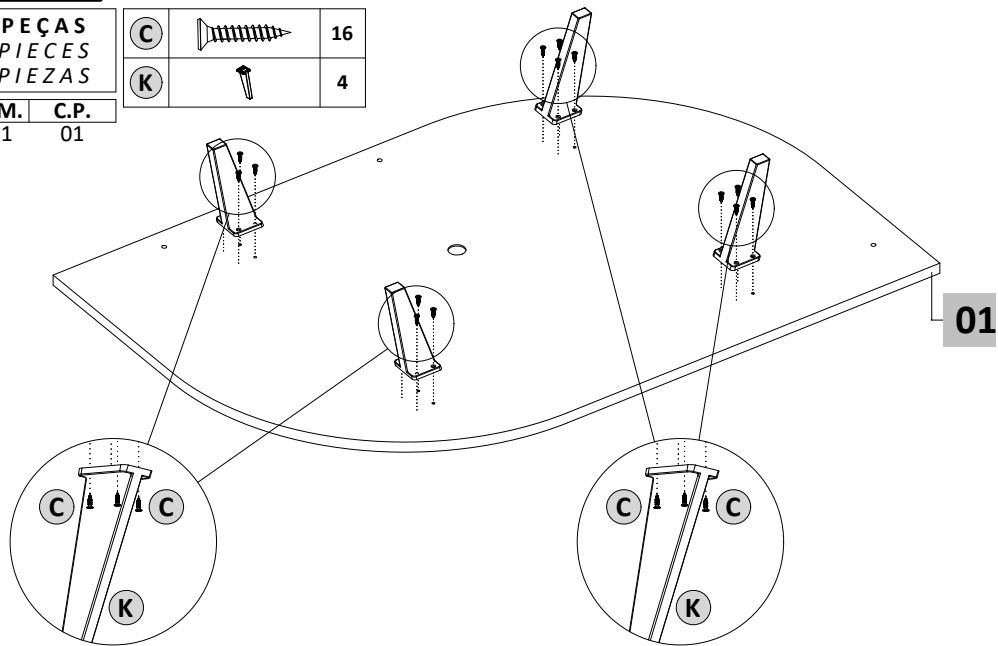

### 2º PASSO

PEÇAS PIECES PIEZAS		<b>01</b>	<b>01</b>
		<b>02</b>	<b>03</b>
		<b>03</b>	<b>03</b>

S.M.	C.P.
01	01
02	03
03	03

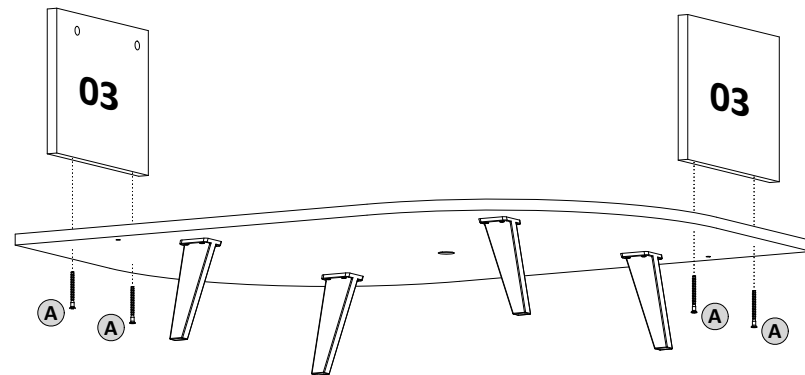

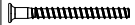

<b>A</b>		4
----------	---	---

### 3º PASSO

PEÇAS PIECES PIEZAS		<b>B</b>		2
		<b>G</b>		2

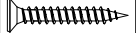
S.M.	C.P.
01	05
02	05

<b>B</b>		2
<b>G</b>		2

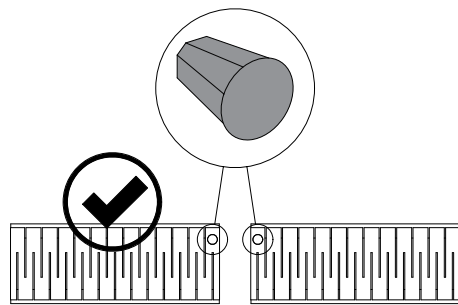

Porta esquerda

Porta direita

**NÃO** devem ser montado as portas conforme imagens abaixo

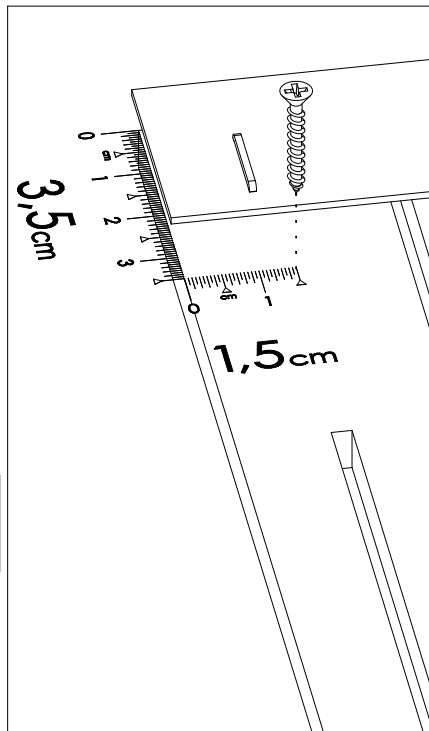
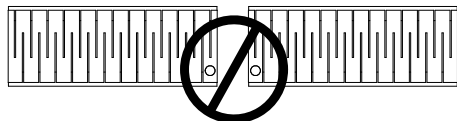

### 4º PASSO

PEÇAS PIECES PIEZAS		<b>J</b>		2
---------------------------	--	----------	--	---

S.M.	C.P.
<b>J</b>	

<b>J</b>		2
----------	--	---

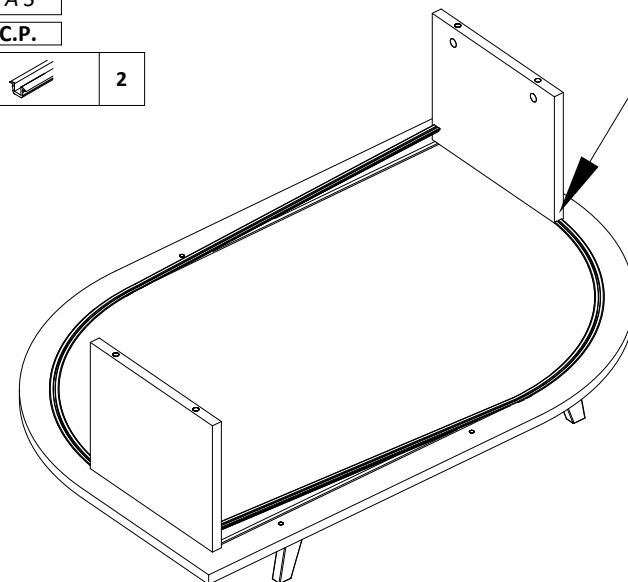

**Atenção!!!**  
Iniciar a colocação do trilho pelo topo da lateral menor.

**5º PASSO**

Encaixando a parte inferior da porta no canal do trilho

Encaixando a parte inferior da porta no canal do trilho

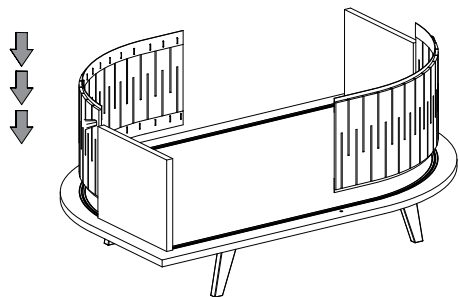

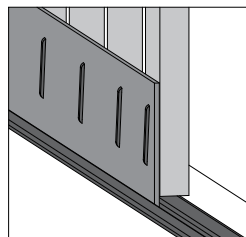

PORTA



**6º PASSO**

PEÇAS  
PIECES  
PIEZAS

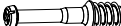
S.M.	C.P.
01	02
02	04
03	04

(D)		4
(F)		4
(H)		4

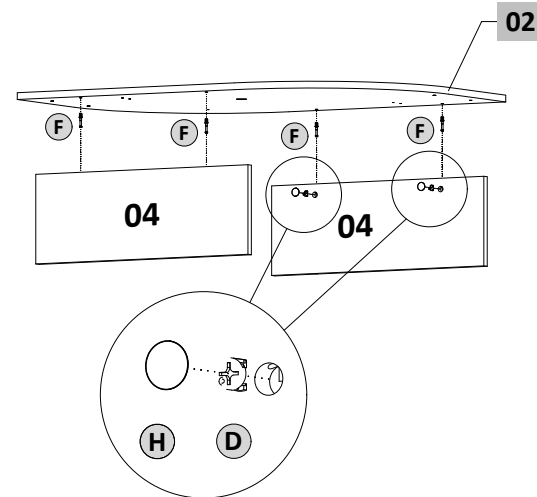



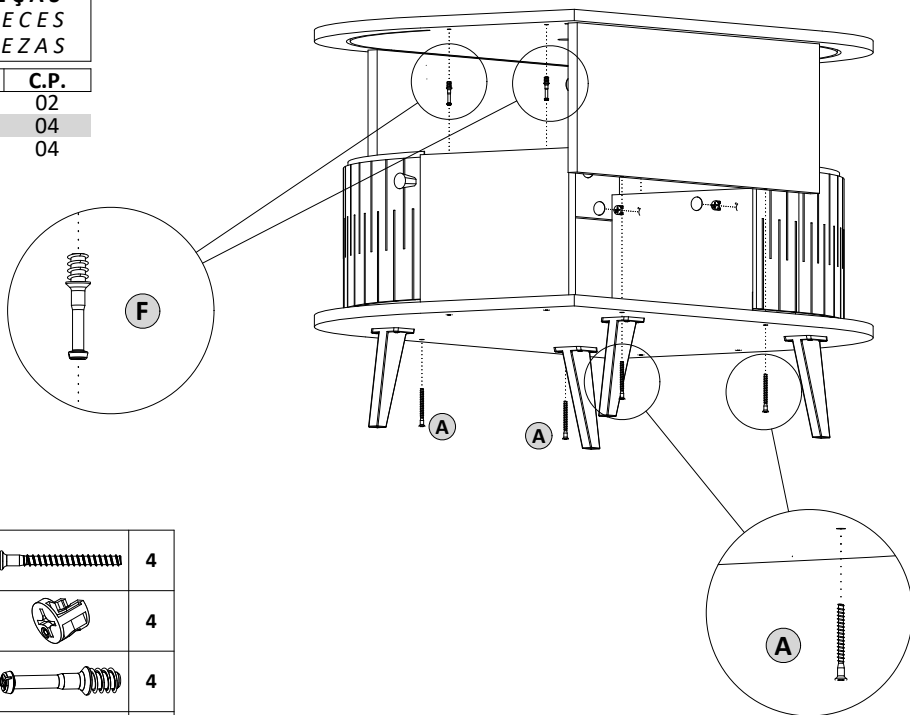

**7º PASSO**

PEÇAS  
PIECES  
PIEZAS

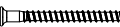
S.M.	C.P.
01	02
02	04
03	04

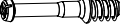

(A)		4
(D)		4
(F)		4
(H)		4

