

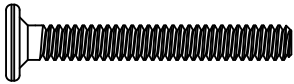



ESQUEMA DE MONTAGEM – MESA BELLE

(2 VOL.)

Pág 1

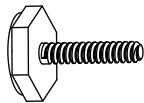
CÓD	DESENHO	QTD	NOME (ONDE USAR)
A		8	PARAFUSO 1/4 x 50
B		6	PARAFUSO 4.0 x 14
C		8	TAMPINHA CPL
D		6	SAPATA REGULAVEL
E		6	PONTEIRA 40 x 20

LISTA DE PEÇAS

Nº PEÇA	CÓD. IND.	DESCRIÇÃO	QTD.	DIMENSÕES (mm)		
				COMP.	LARG.	ESP.
1	3571	Tampo	01	1180	800	15
2	3568	Pé	02	745	535	20
3	3569	Pé Central	02	745	230	20

PESO MÁXIMO SUPORTADO:
20 KG

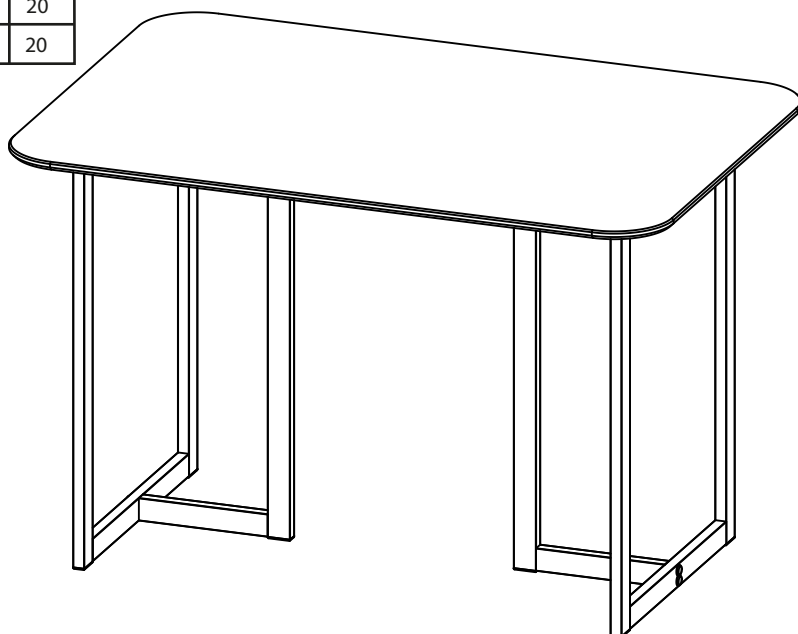

PRODUTO MONTADO 1180 x 800 x 770

ATENÇÃO

- 1-Ler e observar atentamente toda instrução antes de iniciar a montagem.
- 2-A montagem do produto deverá ser feita em superfície limpa e plana. Aconselhamos utilizar a embalagem para forrar o chão a fim de não danificar o produto.
- 3-Os parafusos devem ser apertados periodicamente.
- 4-Evitar batidas e contatos com objetos cortantes.

LIMPEZA

- 1-Pano levemente umedecido com água, seguido de pano seco.
- 2-Não utilizar produtos químicos ou abrasivos.



2 PESSOA



ATENÇÃO SR. MONTADOR: PARA EVITAR AVARIAS AO PRODUTO QUANDO MONTADOS COM PARAFUSADEIRAS O MESMO DEVERÁ SER MONTADO COM TORQUE BAIXO.

1 PASSO: Montar os pés.

2x

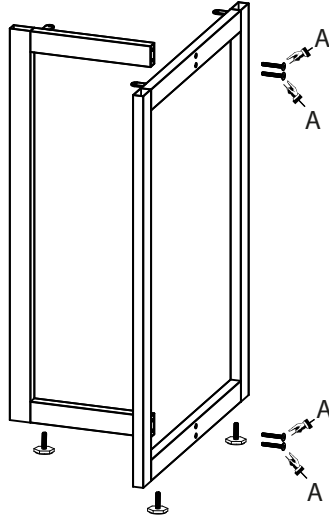
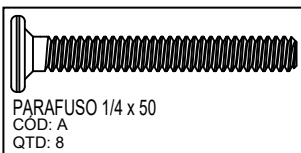
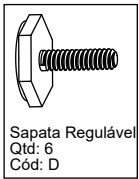

2 PASSO: Montar os pés.

2x

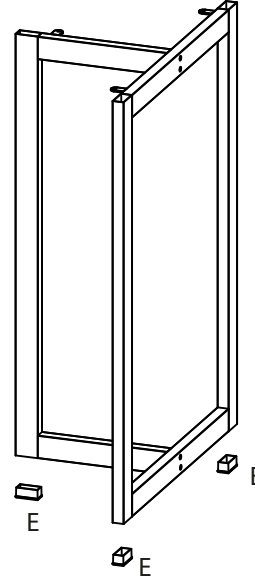

3 PASSO: Parafusar os pés no Tampo.

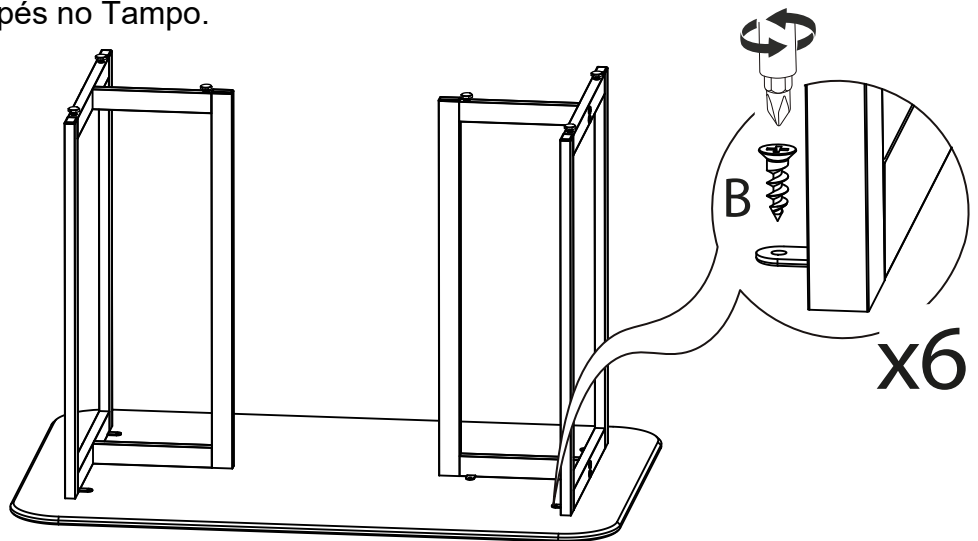
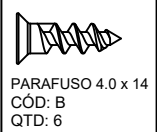

4 PASSO: Colocar as Tampinhas.

