

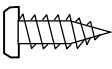

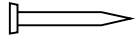
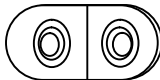

**RELAÇÃO DE FERRAGENS (ESCALA 1 X 1)**

| CÓD | DESENHO  | QTD | NOME (ONDE USAR)                              |
|-----|--|-----|---|
| A   |   | 16  | Paraf 1/4" x 100 -<br>Fixa Travessas nos Pés  |
| B   |   | 16  | Paraf 3.5" x 12 - Fixa tampo                  |
| C   |   | 8   | Prego 8 x 8 - Fixa Sapata                     |
| D   |   | 8   | Cantoneira "L" metálica 18 x 18<br>Fixa tampo |
| E   |   | 16  | Porca Meia Lua                                |
| F   |   | 16  | Tampinha plástica 12 mm – Acabam              |
| G   |  | 4   | Sapata Dominó<br>Proteger os pés.             |

**DESCRIÇÃO DE PEÇAS**

| CÓDIGOS | QTD | NOME           | DETALHES               |
|---------|-----|----------------|------------------------|
| 1       | 1   | Tampo          | MDF 15 x 1200 x 800 mm |
| 2       | 4   | Pés            | MDF 60 x 60 x 750 mm   |
| 3       | 2   | Travessa maior | MDF 15 x 1000 x 100 mm |
| 4       | 2   | Travessa menor | MDF 15 x 100 x 600 mm  |

**PESO MÁXIMO SUPORTADO:**  
40 KG

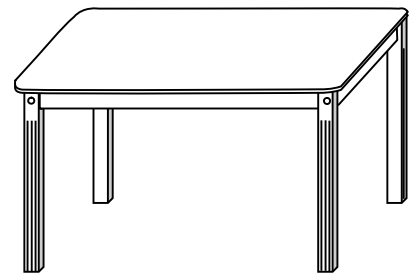

DIMENSÕES DO PRODUTO MONTADO: 1200 X 800 X 750 MM

**Ferramentas Necessárias**



1 PESSOA



**ATENÇÃO**

- 1-Ler e observar atentamente toda instrução antes de iniciar a montagem.
- 2-A montagem do produto deverá ser feita em superfície limpa e plana. Aconselhamos utilizar a embalagem para forrar o chão a fim de não danificar o produto.
- 3-Os parafusos devem ser apertados periodicamente.
- 4-Evitar batidas e contatos com objetos cortantes.
- 5-Reapertar os parafusos após a montagem.

**LIMPEZA**

- 1-Pano levemente umedecido com água, seguido de pano seco.
- 2-Não utilizar produtos químicos ou abrasivos.

## MONTANDO PASSO A PASSO

**1º PASSO:** MONTAR OS PÉS DA MESA UTILIZANDO AS TRAVESSAS MENORES.

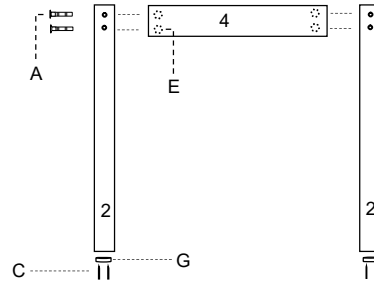
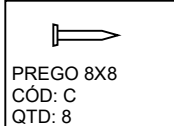
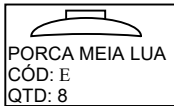
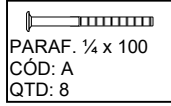

**2º PASSO:** MONTAR AS TRAVESSAS MAIORES NOS PÉS JÁ MONTADOS NO PASSO ANTERIOR, FORMANDO A BASE DA MESA.

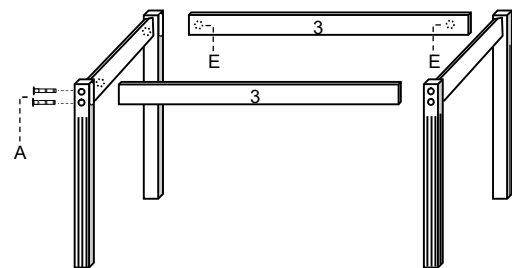
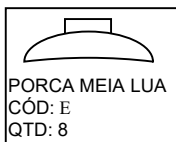
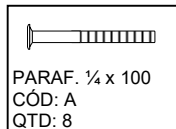

**3º PASSO:** CENTRALIZAR E PARAFUSAR O TAMPO NA BASE DA MESA.

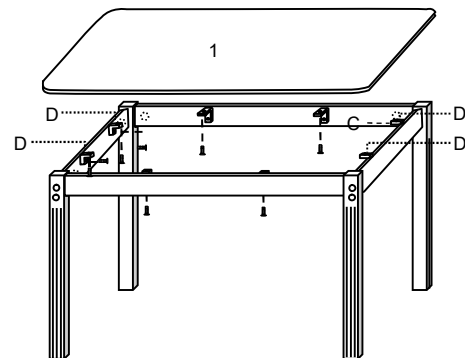
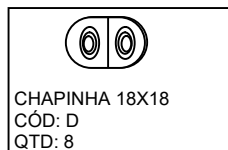
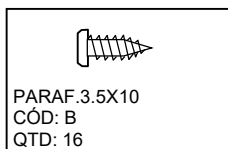

**DICA:** Para facilitar a montagem vire a mesa de cabeça para baixo, protegendo com a própria embalagem para evitar danos ao produto

**4º PASSO:** COLOCAR AS TAMPINHAS DE ACABAMENTO.

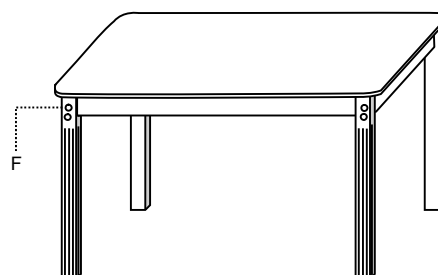

**IMPORTANTE:** PARA FACILITAR A MONTAGEM, VIRE A MESA DE CABEÇA PARA BAIXO, PROTEGENDO AS PEÇAS PARA NÃO RISCAR