

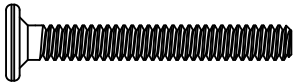



# ESQUEMA DE MONTAGEM – MESA MILA

(1 VOL.)

Pág 1

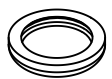
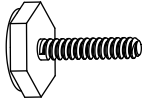
CÓD	DESENHO	QTD	NOME (ONDE USAR)
A		4	PARAFUSO 1/4 x 50
B		6	PARAFUSO 4.0 x 14
C		4	TAMPINHA CPL
D		6	SAPATA REGULAVEL
E		6	PONTEIRA 30 x 20

## LISTA DE PEÇAS

Nº PEÇA	CÓD. IND.	DESCRIÇÃO	QTD.	DIMENSÕES (mm)		
				COMP.	LARG.	ESP.
1	3658	Tampo	01	1180	800	15
2	3614	Pé	02	745	535	20
3	3615	Pé Central	02	745	230	20

PESO MÁXIMO SUPORTADO:  
20 KG

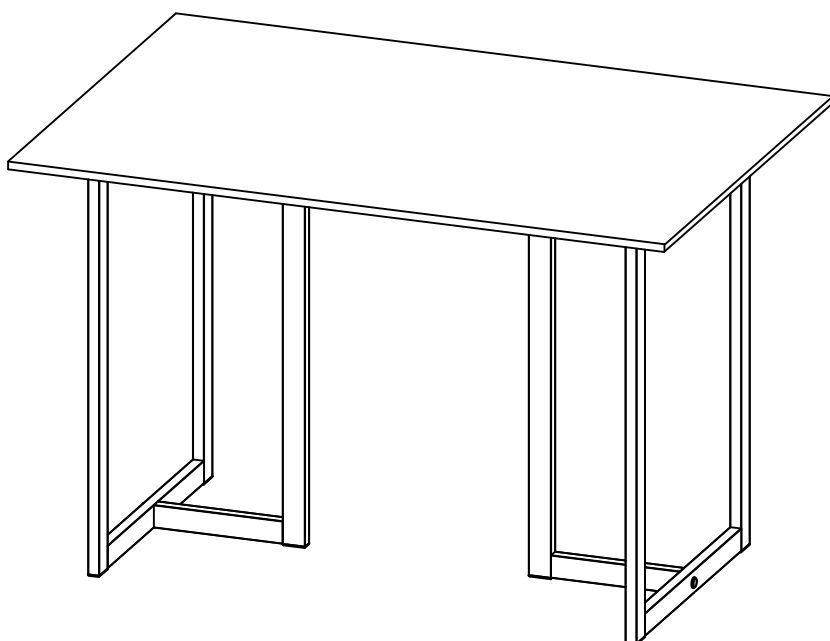

PRODUTO MONTADO 1180 x 800 x 770

### ATENÇÃO

- 1-Ler e observar atentamente toda instrução antes de iniciar a montagem.
- 2-A montagem do produto deverá ser feita em superfície limpa e plana. Aconselhamos utilizar a embalagem para forrar o chão a fim de não danificar o produto.
- 3-Os parafusos devem ser apertados periodicamente.
- 4-Evitar batidas e contatos com objetos cortantes.

### LIMPEZA

- 1-Pano levemente umedecido com água, seguido de pano seco.
- 2-Não utilizar produtos químicos ou abrasivos.



2 PESSOA



**ATENÇÃO SR. MONTADOR:** PARA EVITAR AVARIAS AO PRODUTO QUANDO MONTADOS COM PARAFUSADEIRAS O MESMO DEVERÁ SER MONTADO COM TORQUE BAIXO.

## 1 PASSO: Montar os pés.

2x

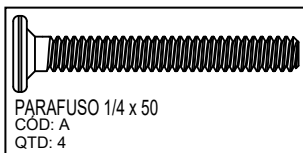
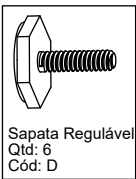
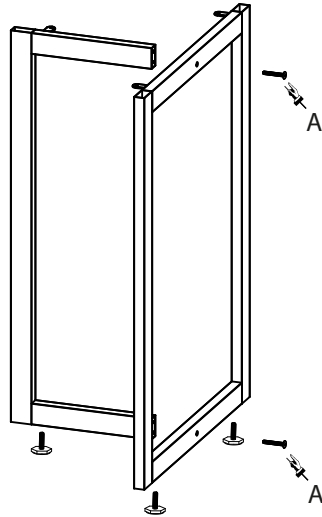

## 2 PASSO: Colocar as Ponteiros

2x

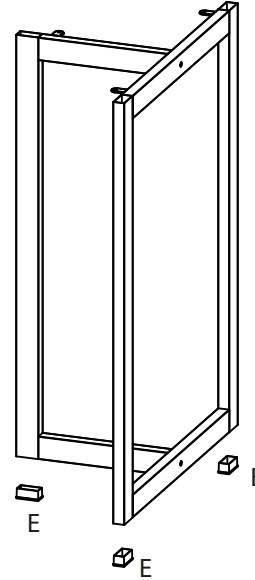

## 3 PASSO: Parafusar os pés no Tampo.

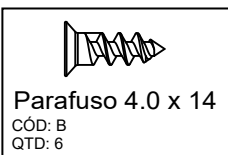
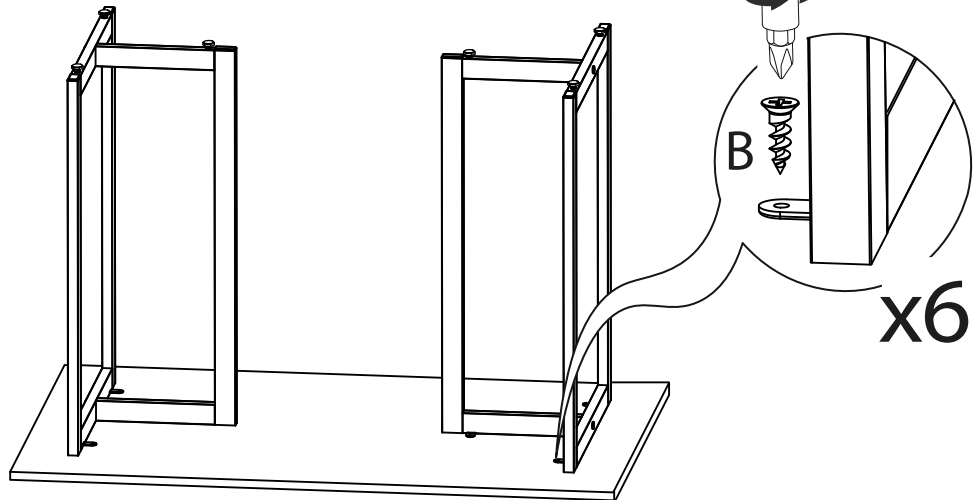

## 4 PASSO: Colocar as Tampinhas.

