

be

mobiliário inteligente

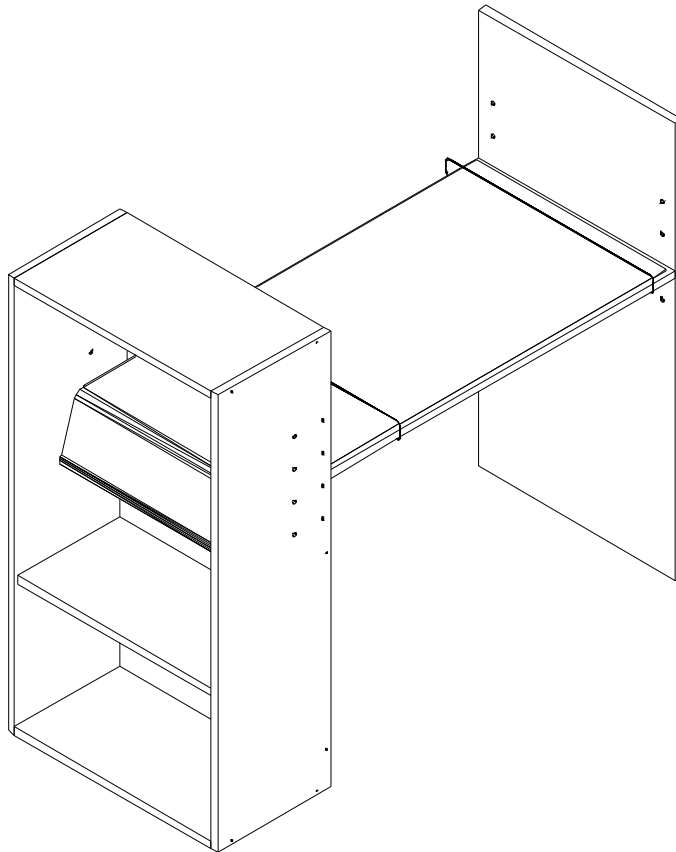

1007 KIDS - MESA DE DESENHO INFANTIL
1007 KIDS - MESA DE DIBUJO PARA NIÑOS
1007 KIDS - CHILDREN DRAWING TABLE

INSTRUÇÕES DE MONTAGEM, INSTRUCCIONES DE MONTAJE, ASSEMBLY INSTRUCTIONS



www.bemobiliario.com.br

R. Joana Guindani Tonello, 1952 - Industrial, Bento Gonçalves - RS, 95706-300
atendimento@bemobiliario.com.br

IMPORTANTE

- Depois de desembalar este produto, por favor mantenha a embalagem original, caso ela precise ser devolvida por alguma razão.
- Verifique se todos os acessórios e peças estão presentes antes de iniciar a montagem.
- Recomendamos que você coloque um cobertor ou lençol no chão para evitar danos no móvel e no piso.
- É altamente recomendável que você mantenha as crianças afastadas da sua área de trabalho.
- Monte este produto o mais próximo possível da sua posição final.
- Nunca arraste ou empurre os produtos, pois isso pode causar danos na estrutura do móvel.
- Não arraste ou empurre itens no móvel, pois isso pode arranhar a superfície.
- Não coloque este produto próximo a um aquecedor ou sob a luz direta do sol.
- A madeira é um produto natural e pode se expandir se for submetida à umidade ou pode encolher e rachar.
- Portanto, recomenda-se que a temperatura ambiente seja mantida, sem oscilações repentinas.
- Certifique-se de que qualquer derramamento seja limpo imediatamente.
- Não coloque itens quentes ou refrigerados diretamente sobre o móvel, utilize uma proteção.
- Para limpeza geral, use um pano macio de algodão ou microfibra e não use detergentes.
- Não coloque o móvel sobre um piso molhado ou úmido, pois pode danificar o produto.
- De tempos em tempos, talvez seja necessário apertar os acessórios, devem ser realizadas inspeções regulares.

IMPORTANTE

- Después de desempacar el producto, conserve el embalaje original en caso de que deba devolver por algún motivo.
- Verifique que todos los accesorios y piezas estén presentes antes de comenzar el montaje.
- Recomendamos que coloque una manta o sábana en el piso para evitar daños en el mueble y al piso.
- Se recomienda encarecidamente que mantenga a los niños alejados de su área de trabajo.
- Monte este producto lo más cerca posible de su posición final.
- Nunca arrastre ni empuje productos, ya que esto puede dañar la estructura del mueble.
- No arrastre ni empuje artículos sobre el mueble, ya que esto puede rayar la superficie.
- No coloque este producto cerca de un calentador o bajo la luz solar directa.
- La madera es un producto natural y puede expandirse si se expone a la humedad o puede encogerse y agrietarse. Por lo tanto, se recomienda mantener la temperatura ambiente, sin fluctuaciones repentinas.
- Asegúrese de limpiar cualquier derrame de inmediato.
- No coloque artículos calientes o refrigerados directamente sobre el mueble, use una protección.
- Para la limpieza general, use un paño suave de algodón o microfibra y no use detergentes.
- No coloque la unidad sobre un piso mojado o húmedo, ya que esto puede dañar el producto.
- De vez en cuando, puede ser necesario apretar los accesorios, se deben realizar inspecciones periódicas.

IMPORTANT

- After unpacking this product please keep the original packaging incase it needs to be returned for any reason.
- Please ensure all fittings and parts are present before commencing with assembly.
- We recommend that you lay a blanket or sheet on the floor to avoid damage to both your floor and the product.
- We strongly recommend that you keep children away from your work area.
- Assemble this product as close to its final position as possible.
- Never drag or push products as this could cause damage to the joints making it inferior.
- Do not drag or push items across your furniture as this may cause the surface to scratch.
- Do not place this product next to a radiator or in direct sunlight.
- Wood is a natural product and may expand if subjected to damp and may shrink or crack if subjected to heat. Therefore it is recommended that room temperature is maintained, with no sudden temperature fluctuations.
- Make sure any spillage is wiped off immediately.
- Do not place hot or chilled items directly onto the surface, use a place mat or marking will occur.
- For general cleaning use a soft cotton or microfibre cloth, and do not use detergents of any kind.
- Do not place on a wet or damp floor as staining may occur to your floor.
- From time to time it maybe necessary to tighten fittings, regular inspections should be carried out.

REQUERIMENTO
REQUERIMENTO
REQUIRED

Ferramentas
Herramientas
Tools

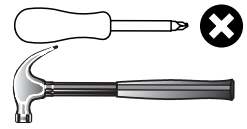

Área
Zona
Area



1500mm x 1500mm

Duas pessoas
Dos personas
Two People

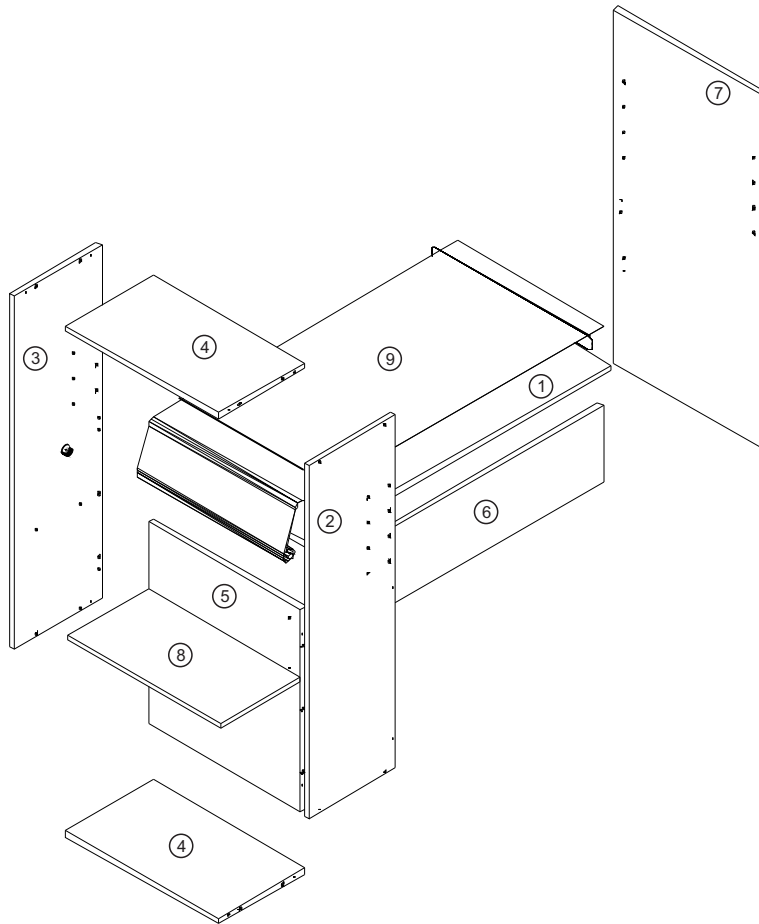
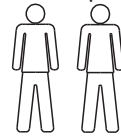











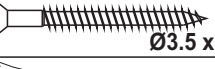

Observe:As peças abaixo foram numeradas/codificadas por cores para ajudar a identifica-las durante a montagem.
Nota:Las siguientes partes han sido numeradas/codificadas por colores para ayudar a identificarlas durante el montaje.
Please Note: the below parts been number/colour coded to help identify them during assembly.

Lista de peças/ Listas de piezas/Parts list

	Cod	Descrição / Denominación/ Description	QTD
1	74966	TAMPO/ TAPA/ TOP	1
2	74967	LATERAL DIREITA/ LATERAL DERECHA /RIGHT SIDE	1
3	74968	LATERAL ESQUERDA/ LATERAL IZQUIERDA/ LEFT SIDE	1
4	74969	TAMPO_BASE/ TAPA_BASE/ TOP_BASE	2
5	74970	DIVISÃO/ DIVISIÓN / DIVISION	1
6	74971	TRAVESSA/ TRAVESAÑO/ FRAME	1
7	74972	LATERAL / LATERAL / SIDE	1
8	74973	PRATELEIRA / ESTANTE/ SHELF	1
9	75016	SUPORTE DE PAPEL/ SOPORTE DE PAPEL/ PAPER SUPPORT	1

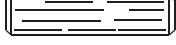
Lista de ferragens/ Lista de herramientas/Hardware List

A	  Ø3.5 x 14	12	E		02	I	 M6X30	06
B	  Ø3.5 x 45	16	F		16	J	 Ø10 x 10	08
C	 GLUE	01	G		02	L		08
D	 Ø8 x 30	18	H		06	M		04

PASSO 1

PASO 1
STEP 1

REQUERIMENTO DE PEÇAS
REQUERIMENTO DE PIEZAS
PARTS REQUIRED

TAMPO		
1- TAPA TOP		X1

TAMPO BASE		
4- TAPA BASE TOP BASE		X2

DIVISÃO		
5- DIVISIÓN DIVISION		X1

TRAVESSA		
6- TRAVESAÑO FRAME		X1

REQUERIMENTO DE FERRAGENS
REQUERIMENTO HERRAMIENTAS
HARDWARE REQUIRED

C		01
---	-----------------------------------------------------------------------------------	----

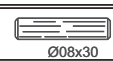
D		18
---	-----------------------------------------------------------------------------------	----

H		06
---	-----------------------------------------------------------------------------------	----

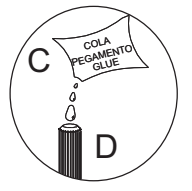
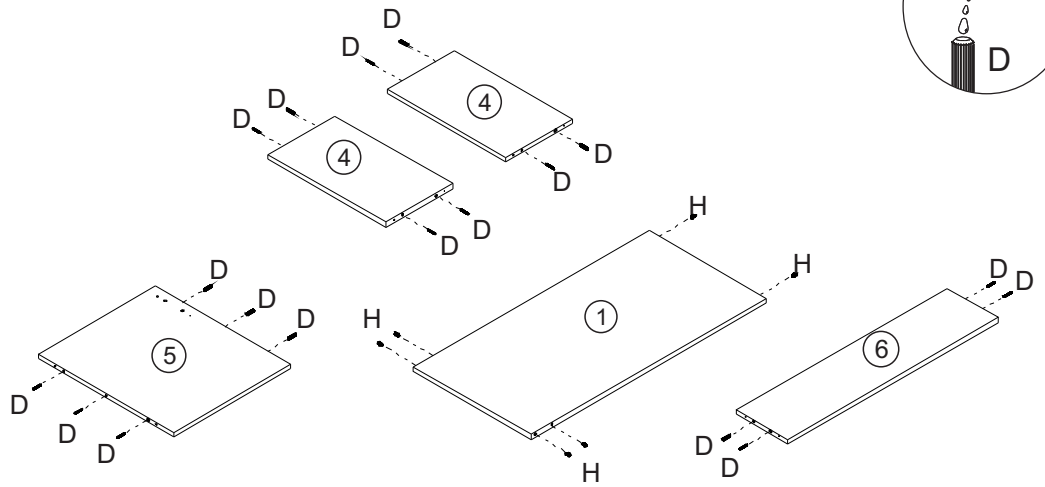

PASSO 2

PASO 2
STEP 2

REQUERIMENTO DE PEÇAS
REQUERIMENTO DE PIEZAS
PARTS REQUIRED

LATERAL ESQUERDA		
3- LATERAL IZQUIERDA LEFT SIDE		X1

REQUERIMENTO DE FERRAGENS
REQUERIMENTO HERRAMIENTAS
HARDWARE REQUIRED

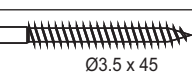
B		06
---	-------------------------------------------------------------------------------------	----

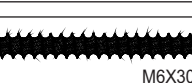
I		02
---	-------------------------------------------------------------------------------------	----

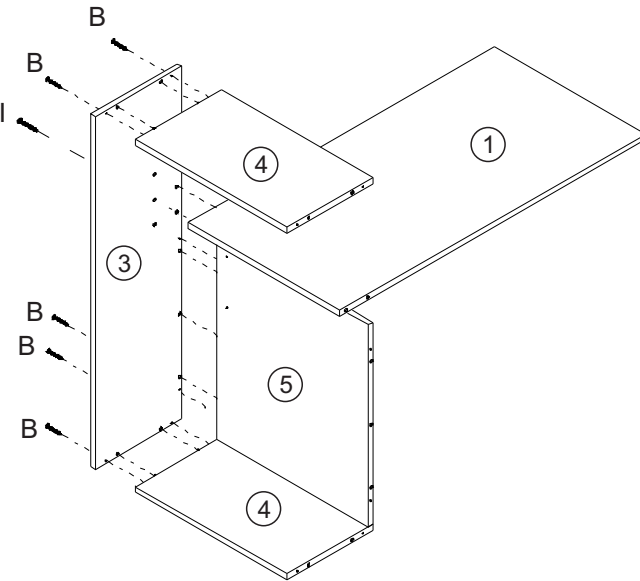

PASSO 4

PASO 4
STEP 4

REQUERIMENTO DE PEÇAS
REQUERIMENTO DE PIEZAS
PARTS REQUIRED

LATERAL DIREITA		
2- LATERAL DERECHA RIGHT SIDE		X1

REQUERIMENTO DE FERRAGENS
REQUERIMENTO HERRAMIENTAS
HARDWARE REQUIRED

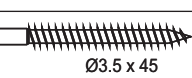
B		06
---	-------------------------------------------------------------------------------------	----

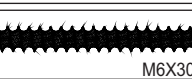
I		02
---	-------------------------------------------------------------------------------------	----

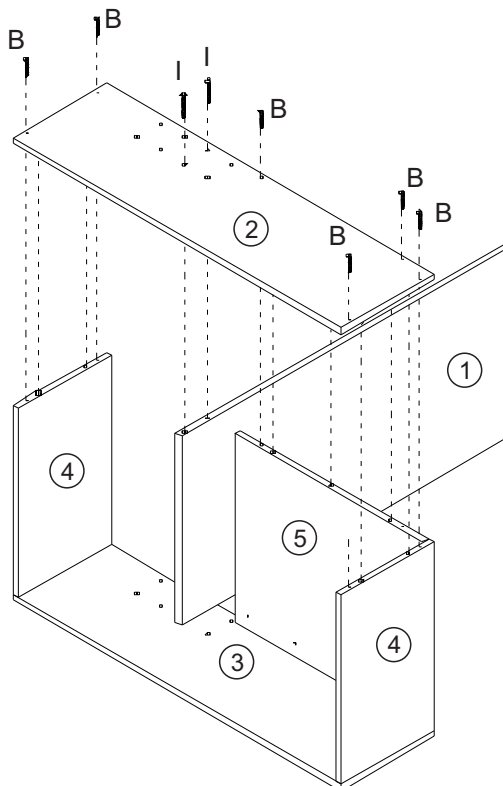

PASSO 5PASO 5
STEP 5REQUERIMENTO DE PEÇAS
REQUERIMENTO DE PIEZAS
PARTS REQUIRED

TRAVESSA 6 - TRAVESAÑO FRAME	X1
-------------------------------------------	----

LATERAL 7 - LATERAL LEFT	X1
---------------------------------------	----

REQUERIMENTO DE FERRAGENS
REQUERIMENTO HERRAMIENTAS
HARDWARE REQUIRED

B  04 Ø3.5 x 45

I  02 M6X30

J  08 Ø10 x 10

L  08

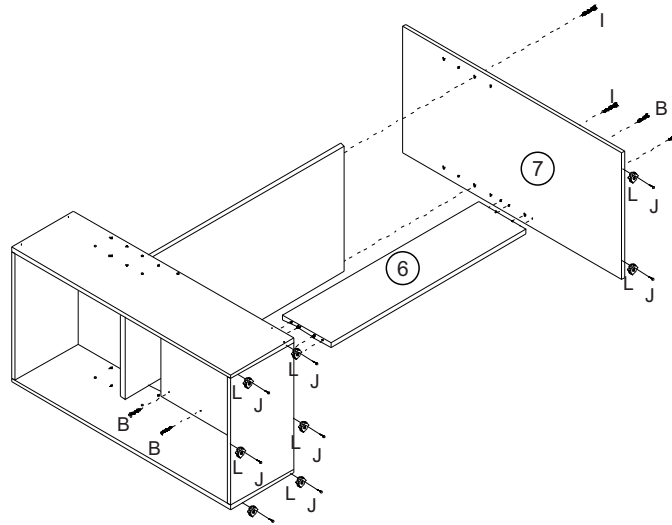
**PASSO 6**PASO 6
STEP 6REQUERIMENTO DE FERRAGENS
REQUERIMENTO HERRAMIENTAS
HARDWARE REQUIRED

G  02

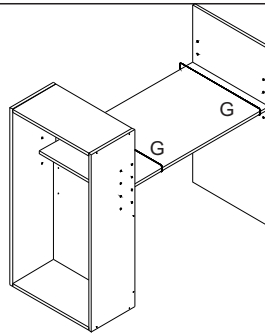
**PASSO 7**PASO 7
STEP 7REQUERIMENTO DE PEÇAS
REQUERIMENTO DE PIEZAS
PARTS REQUIRED

PRATELEIRA 8 - ESTANTE SHELF	X1
-------------------------------------------	----

REQUERIMENTO DE FERRAGENS
REQUERIMENTO HERRAMIENTAS
HARDWARE REQUIRED

A  08 Ø3.5 x 14

M  04

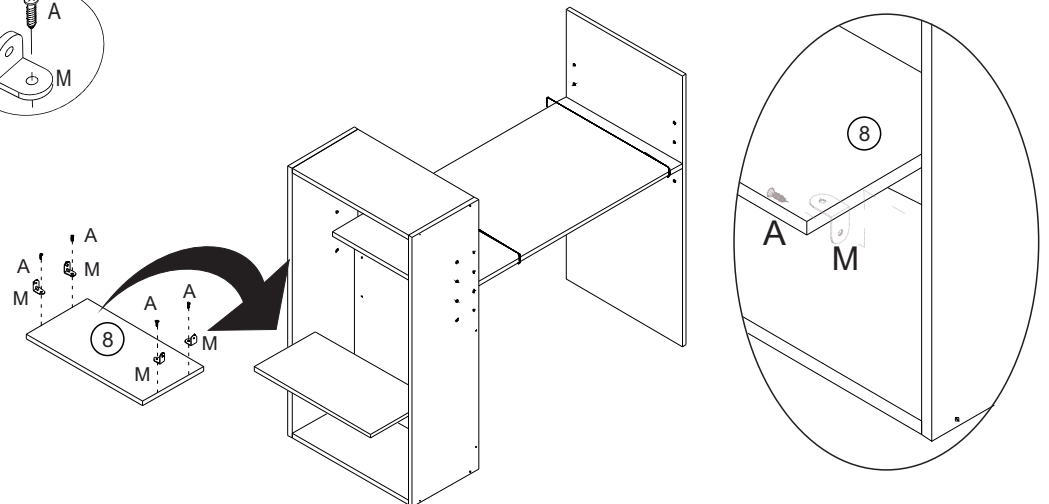
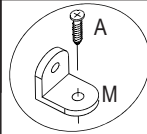
**PASSO 8**PASO 8
STEP 8REQUERIMENTO DE PEÇAS
REQUERIMENTO DE PIEZAS
PARTS REQUIRED

SUPORTE PAPEL 9 - SOPORTE DE PAPEL PAPER SUPPORT	X1
---------------------------------------------------------------	----

REQUERIMENTO DE FERRAGENS
REQUERIMENTO HERRAMIENTAS
HARDWARE REQUIRED

A  02 Ø3.5 x 14

E  02

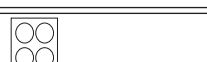
F  16

