



MAVAULAR móveis

Fone (32) 3539-7600

Rod. Ubá - Rodeiro, Km 03 - Galpão 1

C. P. 050 - CEP 36500-000 - Ubá - MG

E-mail: mavaular@mavaular.com.br - Site: www.mavaular.com.br

Facebook and Instagram icons followed by **Mavaular Móveis**



Instruções de Montagem Mesa de Estudos Sevilha

Assembly Instructions Seville Study Table

Instrucciones de Montaje Mesa Estudio Sevilla

CÓDIGO: 10743

Atualizado em: 10/03/2023

CUIDE BEM DO SEU MÓVEL

Dicas de limpeza e conservação:

- Para limpar corretamente seu produto, use sempre um pano liso e **levemente** umedecido com água;
- Não se esqueça de enxugar o seu móvel! Ele não deve permanecer úmido, pois a água pode prejudicar o acabamento ou causar mofo na madeira;
- Não se recomenda o uso de produtos à base de amoníaco.
- Não utilize esponja de aço ou qualquer material que possa arranhar a superfície do produto durante a limpeza.
- Não utilize plásticos ou papéis coloridos para forrar seu móvel.
- Evite arrastar objetos em cima do móvel. Eles podem riscar e prejudicar o acabamento de seu móvel de
- O material dos seus móveis tem um tratamento contra fungos e cupins, mesmo assim, em ambientes infestados recomenda-se a dedetização antes de instalar a seu móvel;
- Tente evitar a exposição direta ao sol. Sugere-se utilização de cortinas para proteger seu móvel;

TAKING GOOD CARE OF YOUR FURNITURE

Cleaning and caring instructions:

- Wipe the wood furniture down with a moist cloth to properly clean the furniture.
- Do not forget to dry your furniture out. Humidity can damage the finish or create mould.
- Chemical products are not recommended;
- Never clean the furniture with scouring powders, steel scrubber pads or any other product which can scratch its surface.
- Furniture surfaces should not be covered with colored plastic or paper sheets.
- Avoid dragging objects on top of the furniture. They might scratch the finishing.
- Wood furniture are made of mould and termites resistant materials, however, it is recommended to use termiticides in infested places before installing the furniture.
- Avoid furniture exposure to direct Sun light. Drapers suggested.

CUIDE BIEN DE SU MUEBLE

Indicaciones de limpieza y conservación

- Para limpiar correctamente su muebles de madera, siempre use un paño húmedo.
- No se olvide de secar su muebles! No debe permanecer húmedo, pues el agua puede perjudicar el acabado o causar moho en la madera.
- No es recomendable utilizar productos con amoníaco.
- No utilizar esponjas de acero o cualquier material que dañe la superficie de los muebles.
- No utilizar plásticos o papeles coloridos para forrar los muebles.
- Evite arrastrar objetos encima de los muebles. Ellos pueden riscar o dañar el acabado de su mueble de cocina.
- El material de los muebles tiene un tratamiento contra los hongos y las polillas, aun así, en ambientes infectados, se recomienda desinfectar antes de instalar su mueble.
- Evite la exposición directa al sol. Se sugiere la utilización de cortinas para proteger sus muebles.

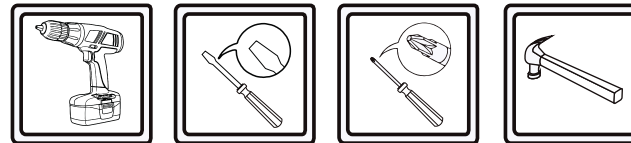
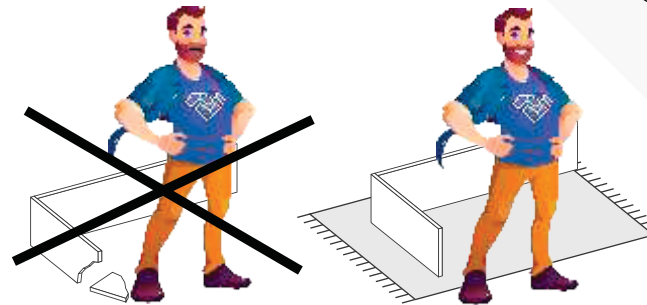
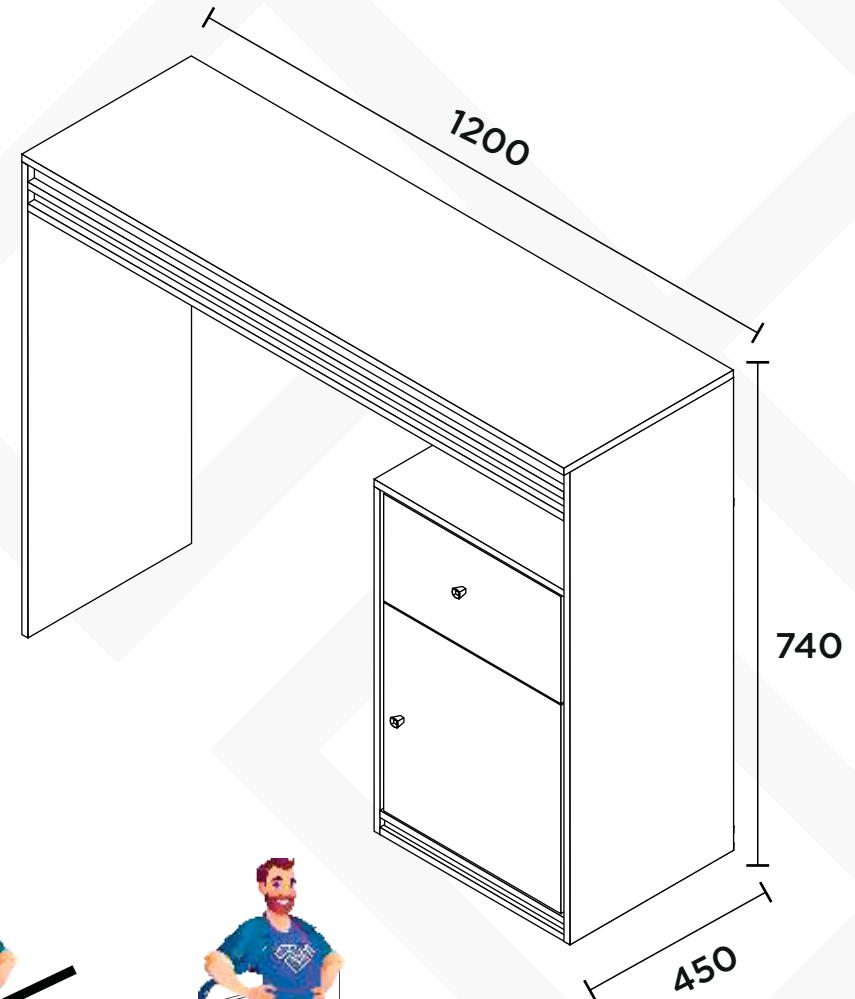









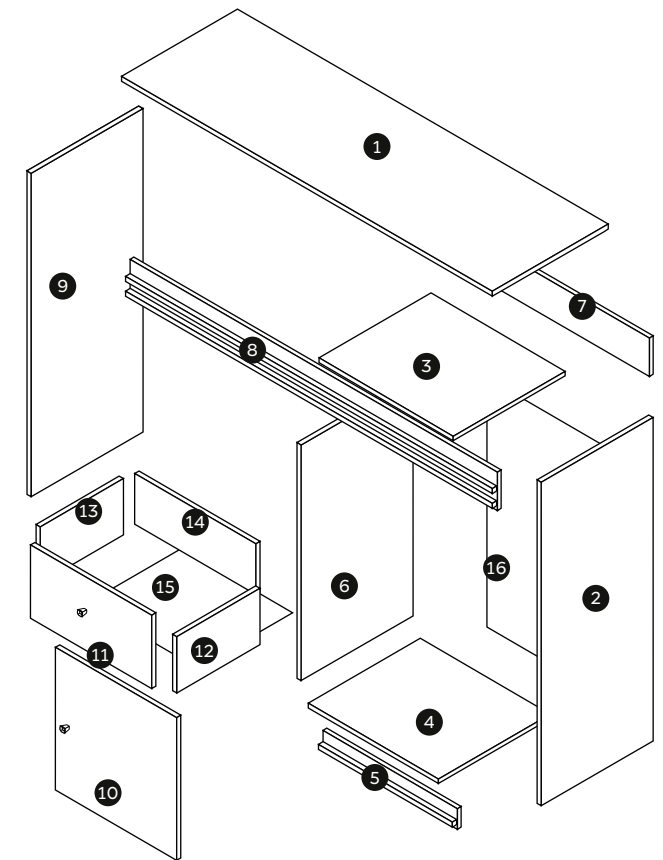

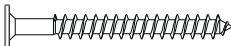

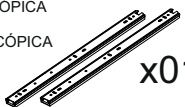

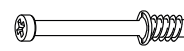

As ferramentas necessárias para montagem do produto não são fornecidas.

The necessary tools for assembly aren't supplied.

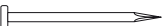
Las herramientas necesarias para armar los productos no son fornecidas.

N°	CÓDIGO CODE CÓDIGO	DESCRIÇÃO DESCRIPTION DESCRIPCIÓN			DIMENSÃO (mm) DIMENSION (mm) DIMENSIÓN (mm)			QUANTIDADE QUANTITY CANTIDAD
					COMP. LEN. LON.	LARG. WID. ANC.	EPS DEP ESP	
1	10744	Tampo	Cover	Cubrir	1200	450	15	1
2	10745	Lateral Direita	Right side	Lado derecho	725	448	15	1
3	10746	Tampo da Porta	Door Top	Parte superior de la puerta	446	322	15	1
4	10750	Base da Porta	Door Base	base de la puerta	442	305	15	1
5	10751	Rodapé Ripado	slatted baseboard	zócalo de listones	305	50	15	1
6	10748	Lateral da Porta	Side of the Door	Lado de la puerta	560	444	15	1
7	10756	Travessa de Segurança	Safety Tray	Bandeja de seguridad	1166	150	15	1
8	10747	Régua Ripada	slatted ruler	regla de listones	1165	60	15	1
9	11461	Lateral Esquerda	Left Side	Lado izquierdo	725	448	15	1
10	10752	Porta	Door	Puerta	368	300	15	1
11	10753	Frente de Gaveta	drawer front	frente del cajón	300	118	15	1
12	10754	Lateral Direta da Gaveta	Straight Side of the Drawer	Lado recto del cajón	350	96	15	1
13	11213	Lateral Esquerda da Gaveta	Left Side of the Drawer	Lado izquierdo del cajón	350	96	15	1
14	10755	Traseiro da Gaveta	Rear of Drawer	Parte trasera del cajón	249	70	15	1
15	10758	Fundo da Gaveta	Drawer Bottom	Parte inferior del cajón	357	263	3	1
16	10757	Costa	Coast	Costa	578	335	3	1



A - PARAFUSO 4X40MM 4X40MM SCREW TORNILLO 4X40MM  x12	G - BATENTE PARA PORTA 3,5X14MM SCREW TORNILLO 3,5X14MM x01	M - PARAFUSO 3,5X25MM 3,5X25MM SCREW TORNILLO 3,5X25MM  x02
B - CORREDIÇA TELESÓPICA TELESCOPIC SLIDE CORREDERA TELESÓPICA  x01	H - PARAFUSO 3,5X14MM 3,5X14MM SCREW TORNILLO 3,5X14MM  x28	N - PARAFUSO MINIFIX MINI FIX SCREW TORNILLO MINIFIJO  x10
C - CONECTOR DE MONTAGEM MOUNTING CONNECTOR CONECTOR DE MONTAJE  x03	I - PARAFUSO 3,5X30MM 3,5X30MM SCREW TORNILLO 3,5X30MM  x05	O - TAMBOR MINIFIX MINIFIX DRUM TAMBOR MINIFIJO  x10
D - PARAFUSO 3,5X14MM 3,5X14MM SCREW TORNILLO 3,5X14MM  x08	J - DOBRADIÇA HINGE BISAGRA  x02	P - BUCHA MINIFIX MINIFIX BUSHING COJINETE MINIFIJO  x04
E - PREGO 10X10 NAIL 10X10 CLAVOS 10X10  x20	K - CALÇO DOBRADIÇA HINGE SHIMS CUÑAS DE BISAGRA  x02	Q - TAPA FURO MINIFIX COVER HOLE MINIFIX CUBIERTA DE AGUJERO MINIFIJO  x04
F - TAPA FURO ADESIVO ADHESIVE HOLE COVER TAPA AGUJERO ADHESIVO  x12	L - PUXADOR PONTUAL SPECIFIC HANDLER MANIPULADOR ESPECÍFICO  x02	R - SAPATA SHOE ZAPATO  x06

