

Cód.	Referência	Cor	Pegças	Qt.	Medidas	M.P.	Piece	Pieza
01	1636A0.001	440	Prateleira superior	1	904x150x25	MDP	Top shelf	Estante superior
02	1636A0.002	690	Tampo	1	1596x298x45	MDP	Cover	Cubierta
03	1636A0.003	440	Apoyo	1	750x100x15	MDP	Support	Apoyo
04	1636A0.004	440	Prateleira inferior	1	750x295x15	MDP	Bottom shelf	Estante inferior
05	1636A0.005	690	Base	1	1580x296x45	MDP	Base	Base
06	1636A0.006	690	Lateral esquerda	1	297x224x15	MDP	Left side	Lado izquierdo
07	1636A0.007	690	Batente	1	278x208x15	MDP	Flap	Solapa
08	1636A0.008	440	Divisão	1	296x208x15	MDP	Division	División
09	1636A0.009	440	Lateral direita	1	296x208x15	MDP	Right side	Lado derecha
10	1636A0.010	690	Porta	1	793x202x15	MDP	Door	Puerta
11	1636A0.011	690	Panel superior	1	1162x400x15	MDP	Top panel	Panel superior
12	1636A0.012	690	Panel superior cen	1	1162x400x15	MDP	Top center panel	Panel central superior
13	1636A0.013	690	Panel inferior cen	1	1162x400x15	MDP	Lower center panel	Panel central inferior
14	1636A0.014	693	Panel inferior	1	1600x360x15	MDP	Bottom panel	Panel inferior
15	1636A0.015	690	Panel lateral	1	1200x438x15	MDP	Side panel	Panel lateral
16	1636A0.016	440	Aplicar	7	1198x52x15	MDP	Apply	Aplicar
17	1636A0.017	690	Travessa superior lat	2	1250x70x15	MDP	Side upper crosspiece	Travesaño superior lateral
18	1636A0.018	690	Travessa inferior lat	2	308x70x15	MDP	Bottom side crosspiece	Travesaño inferior lateral
19	1636A0.019	99	Travessa central mai	1	600x70x15	MDP	Larger center	Travesaño central más grande
20	1636A0.020	99	Travessa fixação sup	1	1360x80x15	MDP	Travessa fixation sup	Travesaño fijación superior
21	1636A0.021	99	Travessa fixação inf	1	1090x80x15	MDP	Travessa fixation inf	Travesaño fijación inferior
22	1636A0.022	99	Travessa central men	3	360x70x15	MDP	Smaller central crosspiece	Travesaño central más pequeño
23	1636A0.023	99	Travessa fixação sup men	2	540x80x15	MDP	Travessa fixation sup men	Travesaño fijación sup men
24	1636A0.024	99	Travessa fixação inf men	2	540x80x15	MDP	Travessa fixation inf men	Travesaño fijación inf men

A	B	C	D	E	F	G	H
Parafuso 3,5x14 cod. 776	Parafuso 4,0x25 cod. 780	Parafuso 4,0x40 cod. 781	Parafuso 4,0x50 cod. 782	Parafuso 5,0x50 cod. 812	Parafuso 5,0x70 cod. 792	Caixilha 6x30 cod. 949	Caixilha 8x20 cod. 5225
08x	08x	04x	02x	02x	09x	01x	01x
Pinos p/ Girofix cod. 152	Tambor Ø12 cod. 183	Porca cilindrica cod. 163	Dobr curva 26mm cod. 131	Calço 12mm cod. 136	Chapa para 2 furos cod. 147	Pivador clean cod. 5285	Luminária cod. 954
01x	01x	12x	02x	04x	06x	01x	01x
Pastes fio 40mm cod. 159	Pastes fio 40mm cod. 907	Burda fixação Ø8 cod. 130	Sarfe de cola cod. 166	Tapa furo Off White cod. 901	Tapa furo Nog Real cod. 3957		

**Cuidados com a limpeza do móvel:**

Não molhar o móvel e não expor em lugar úmido.  
 Do not wet the furniture and do not expose it in a humid place.  
 No moje los muebles y no los esponga en un lugar húmedo.

Não expor o móvel próximo de fontes de calor.  
 Do not expose this furniture close to sources of heat.  
 No exponga el mueble cerca a fuentes de calor.

Limpar apenas com pano limpo e levemente úmido  
 Clean the product using only a clean and slightly damp cloth.  
 Limpiar solo con un paño limpio y ligeramente húmedo

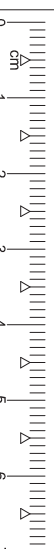
**Mega seu acessório aqui**

# ETAPAS DA MONTAGEM / STAGES OF THE ASSEMBLY / ETAPAS DE LA ASAMBLEA

Para uma montagem perfeita do produto, siga a sequência:

For a perfect product assembly, follow its sequence / Para un montaje perfecto del producto, sigue la secuencia.

**Passo 01**  
Nesse passo montar produto detizado

- A 04x
- B 3,5x14
- D 01x
- D 4,0x50
- G 10x
- G 6x30
- L 02x
- L 02x
- M 01x
- M 02x
- N 01x
- Off white 01x

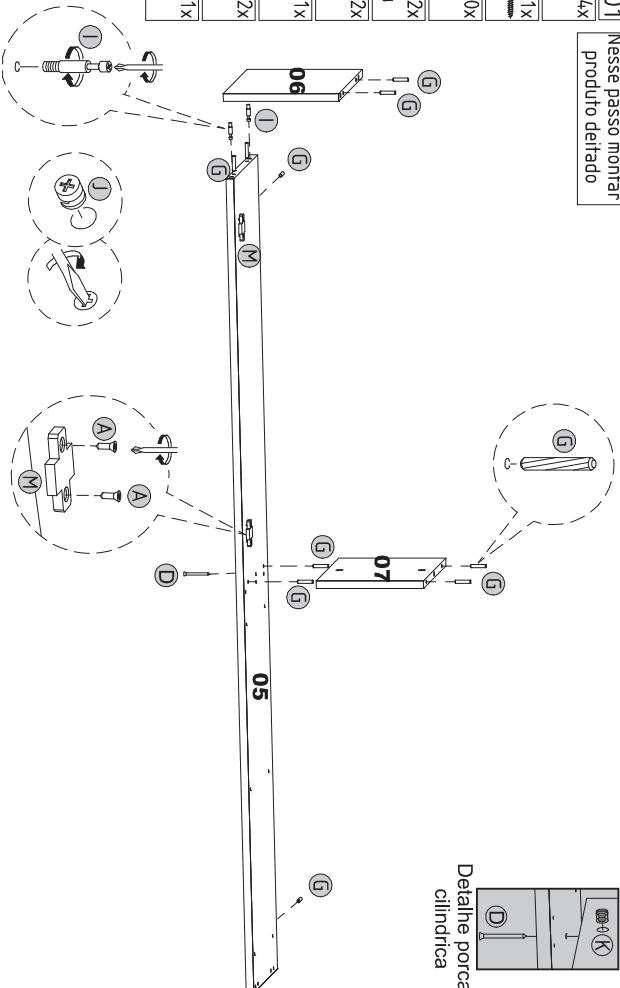

Detalle porca cilíndrica

**Passo 03**  
Nesse passo montar produto detizado

- B 06x
- B 4,0x25
- H 02x
- H 8x20
- G 02x
- G 6x30

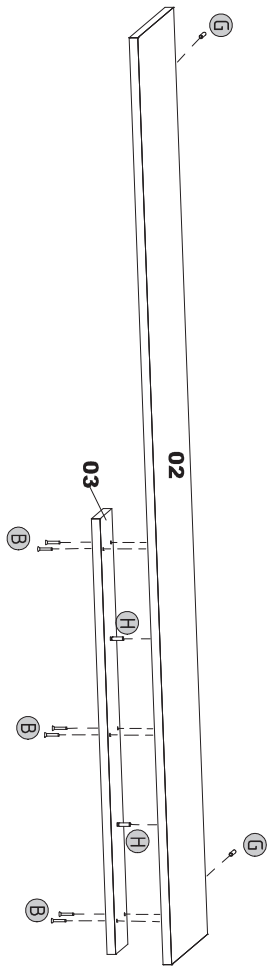

**Passo 02**  
Nesse passo montar produto detizado

- B 06x
- D 4,0x25
- D 01x
- D 4,0x50
- G 04x
- G 6x30
- K 01x
- Nogueira 01x

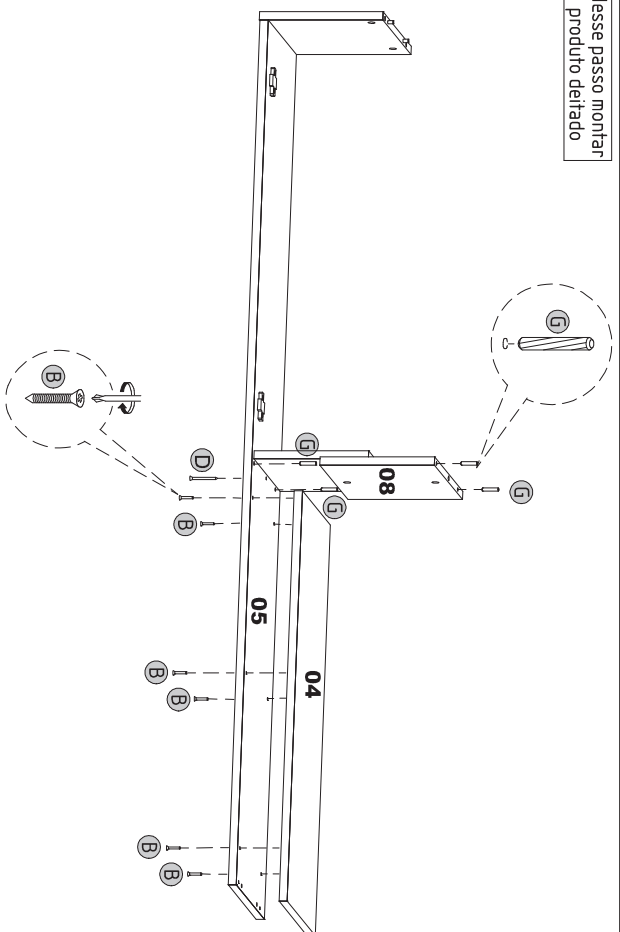

**Passo 04**  
Nesse passo montar produto detizado

- B 06x
- B 8mm
- L 06x
- L 03x
- Off white 05x
- Nogueira 02x
- D 4,0x50
- G 04x
- G 6x30
- K 02x

1º Inserir acessório "1" na peça 02

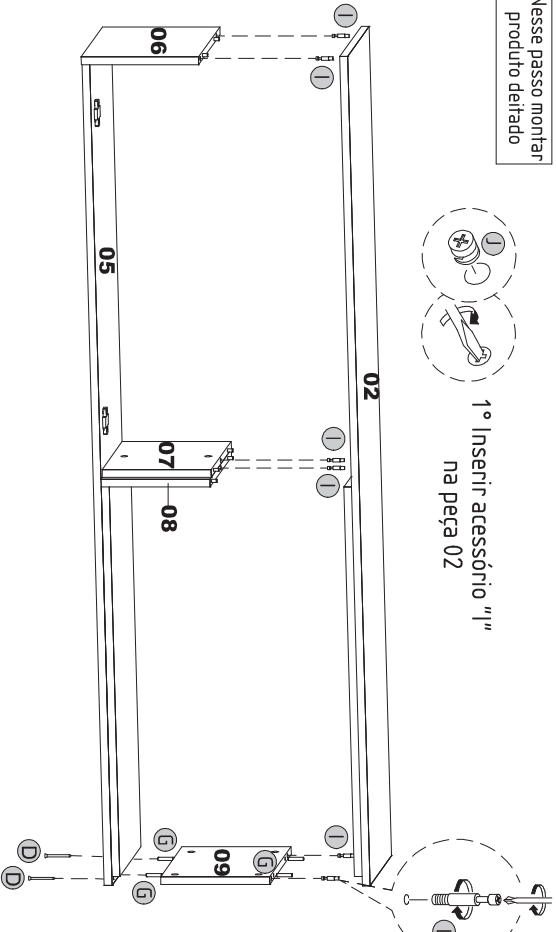

# ETAPAS DA MONTAGEM / STAGES OF THE ASSEMBLY / ETAPAS DE LA ASAMBLEA

Para uma montagem perfeita do produto, siga a sequência:

For a perfect product assembly, follow its sequence / Para un montaje perfecto del producto, sigue la secuencia.

## Passo 05 Vista traseira

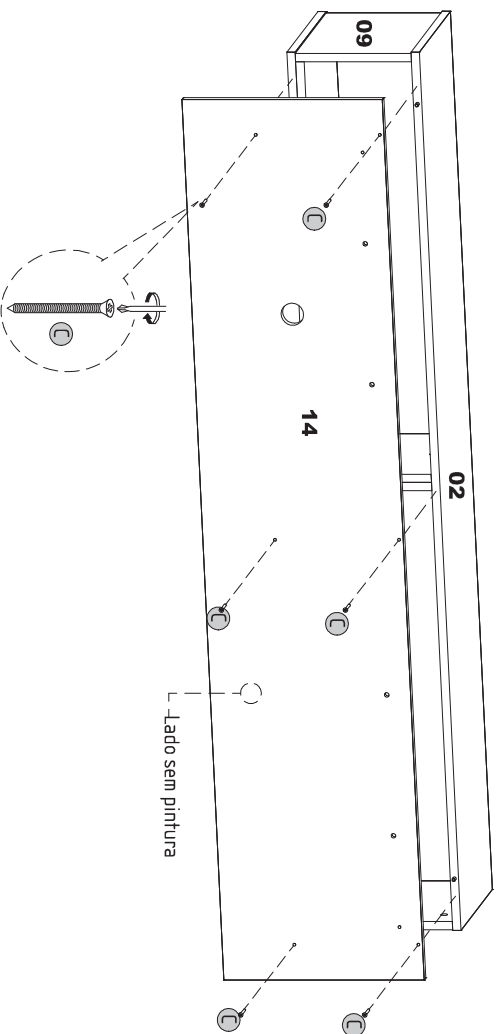
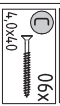

## Passo 06 Vista traseira

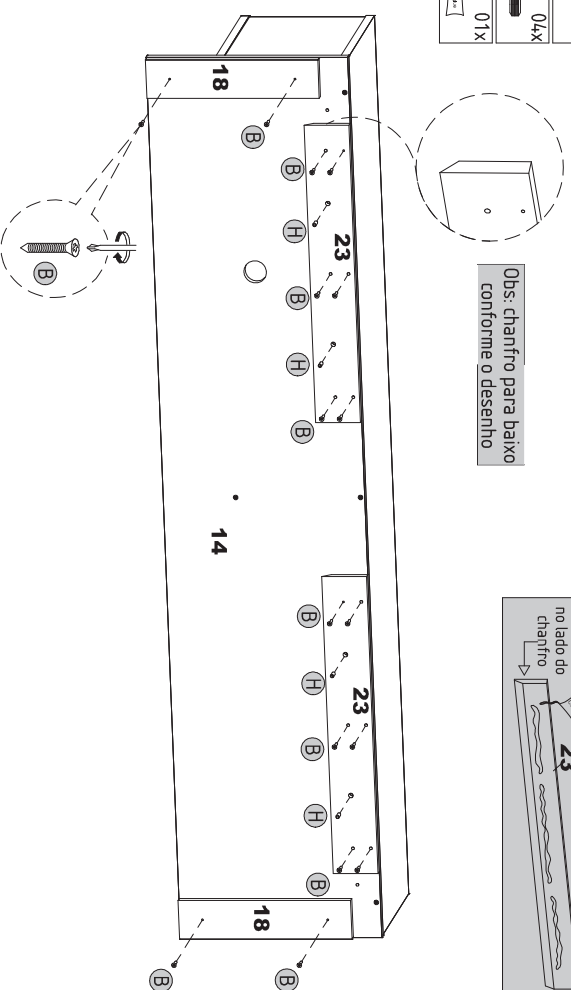
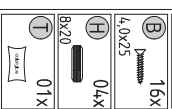

**ATENÇÃO: USO OBRIGATÓRIO DE COLA**

Passar cola no lado do chanfro

23

## Passo 07



Usar canal de guia para fixação

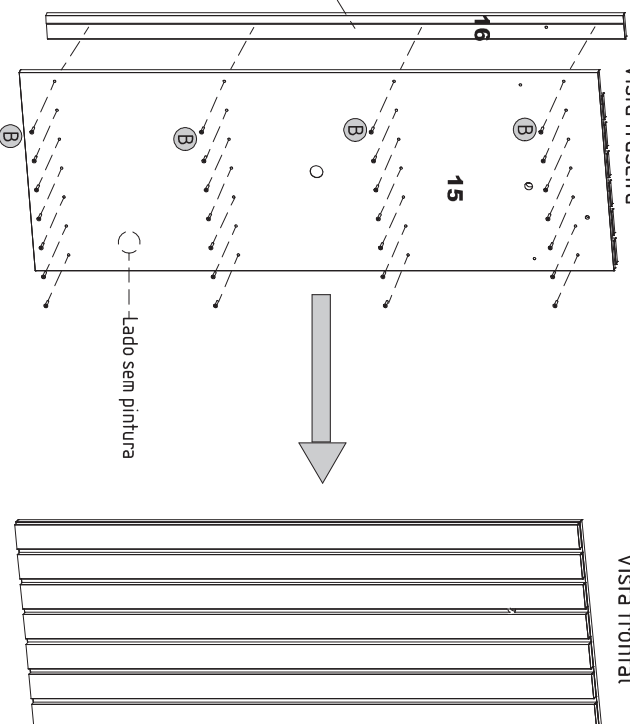

## Passo 08 Vista traseira

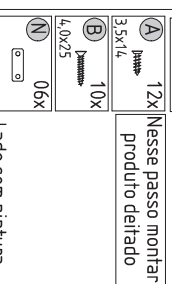

Nesse passo montar produto detornado

Lado sem pintura

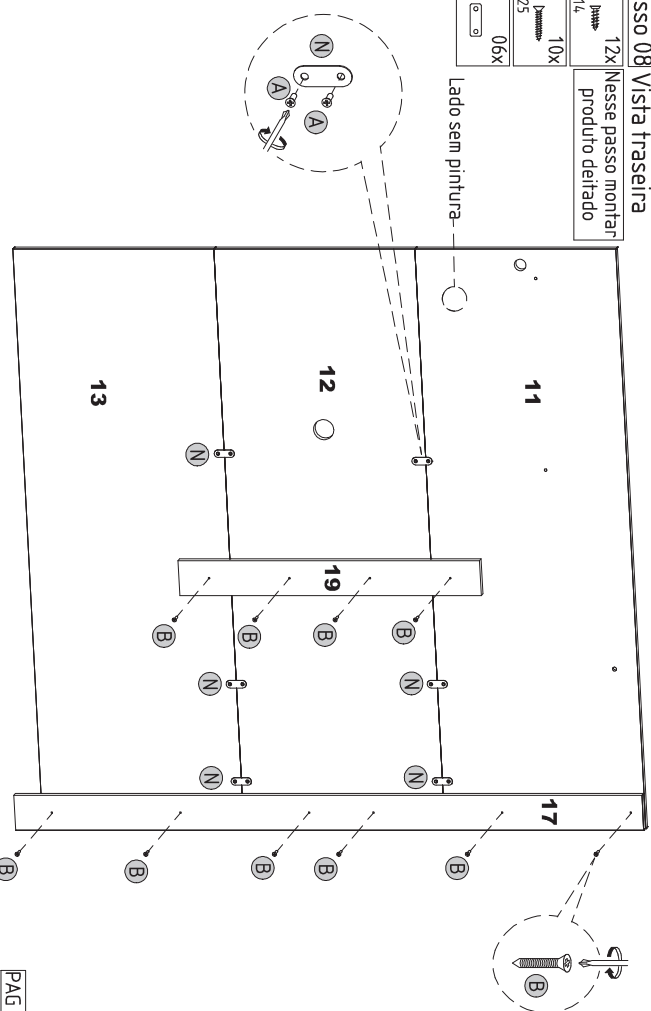

Comear a montar os apliques (16) conforme imagem, de fora para dentro. Deixar rente com a peça 15.

# ETAPAS DA MONTAGEM / STAGES OF THE ASSEMBLY / ETAPAS DE LA ASAMBLEA

Para uma montagem perfeita do produto, siga a sequência:

For a perfect product assembly, follow its sequence / Para un montaje perfecto del producto, sigue la secuencia.

- Passo 09**
- A 06x 3,5x14
  - B 28x 4,0x25
  - N 03x
  - T 01x
  - H 02x 8x20

Vista traseira

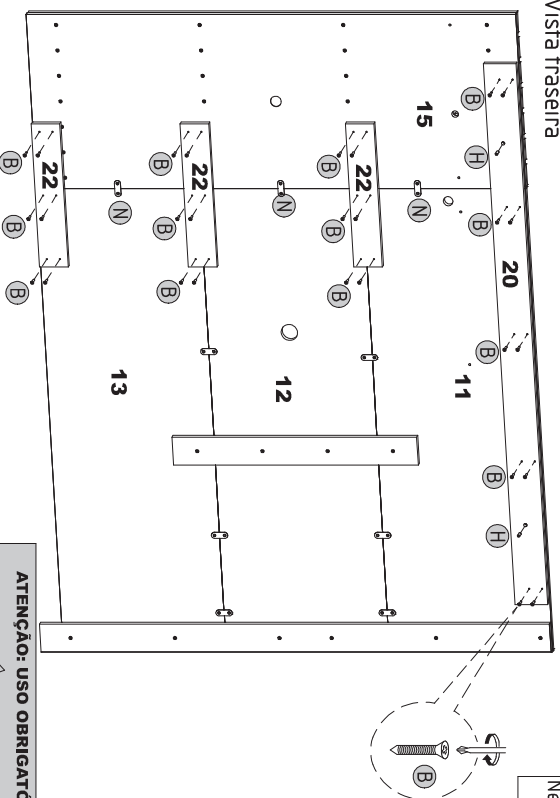

Nesse passo montar produto deitado

**ATENÇÃO: USO OBRIGATORIO DE COLA**  
 Passar cola no lado do charinho

- Passo 11**
- B 06x 4,0x25

Vista traseira

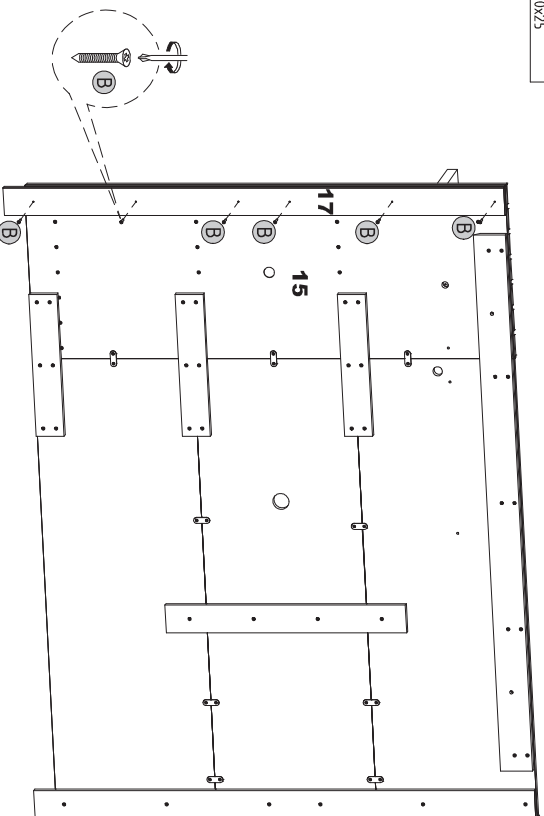

Nesse passo montar produto deitado

- Passo 10**
- E 04x 5,0x50
  - G 02x 6x30
  - P 01x
  - Q 01x

**ATENÇÃO**  
 Vista lateral

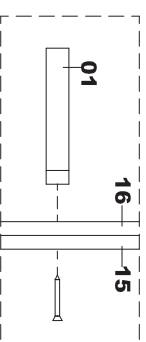

- Usar furração da peça 15 como guia.  
 - Peça 16 não contém furração, fazer o furo com o parafuso.

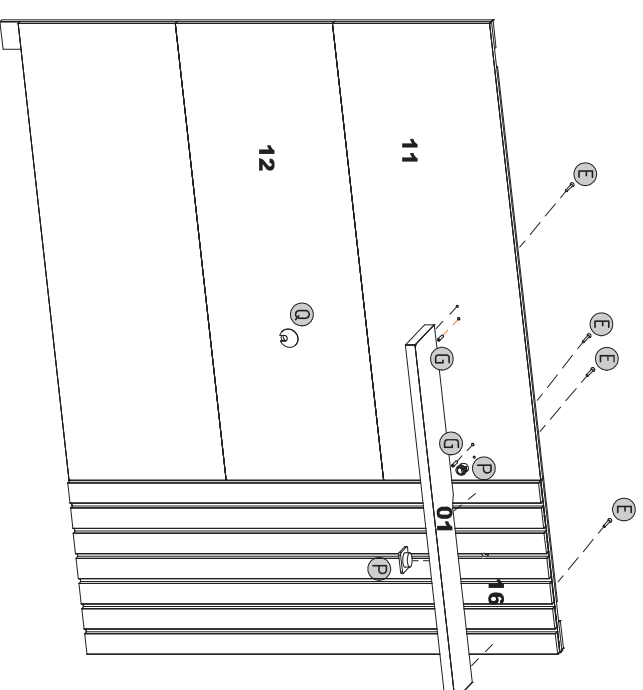

- Passo 12**
- A 06x 3,5x14
  - L 02x
  - O 01x
  - R 01x

Nesse passo montar produto deitado

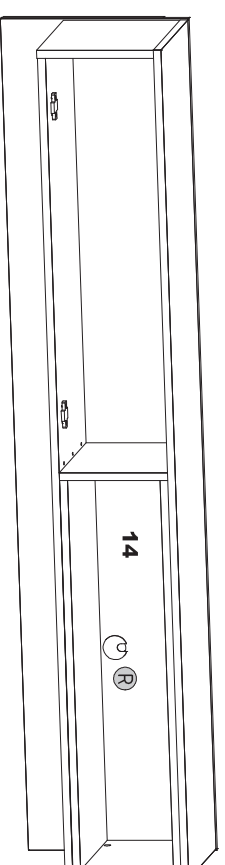

Vista interna

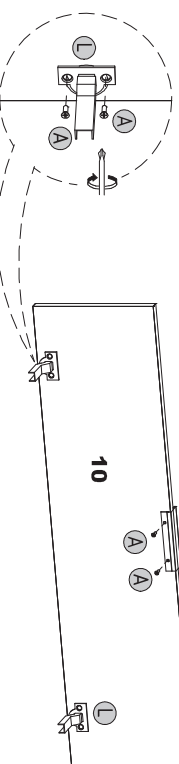

# ETAPAS DA MONTAGEM / STAGES OF THE ASSEMBLY / ETAPAS DE LA ASAMBLEA

Para uma montagem perfeita do produto, siga a sequência:

For a perfect product assembly, follow its sequence / Para un montaje perfecto del producto, sigue la secuencia.

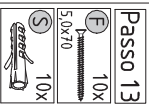

Distância entre as travessas



Sugestão de altura do piso à parte inferior da peça 24

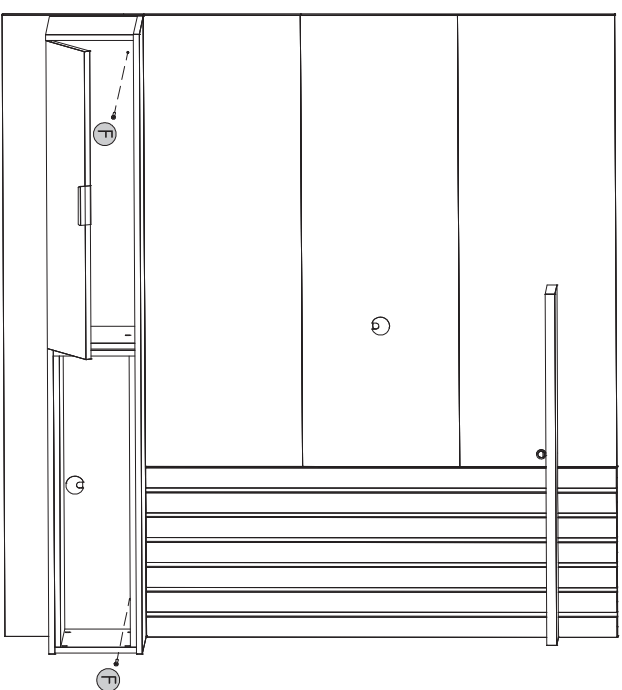
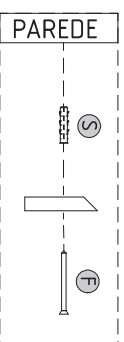
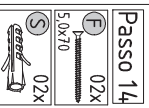
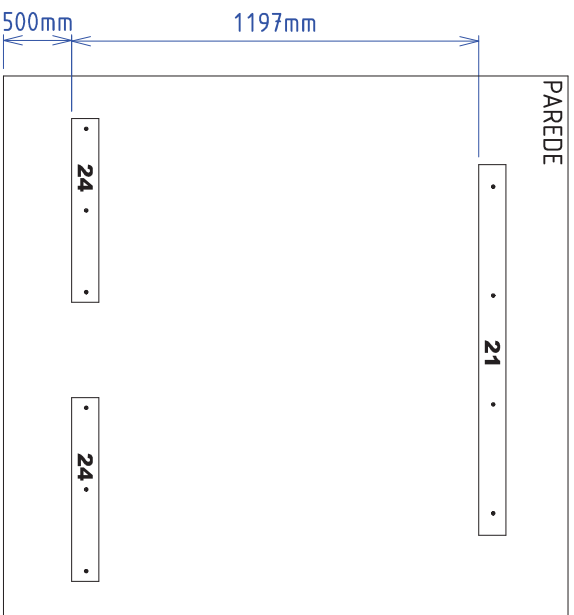
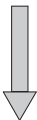

Medida Final

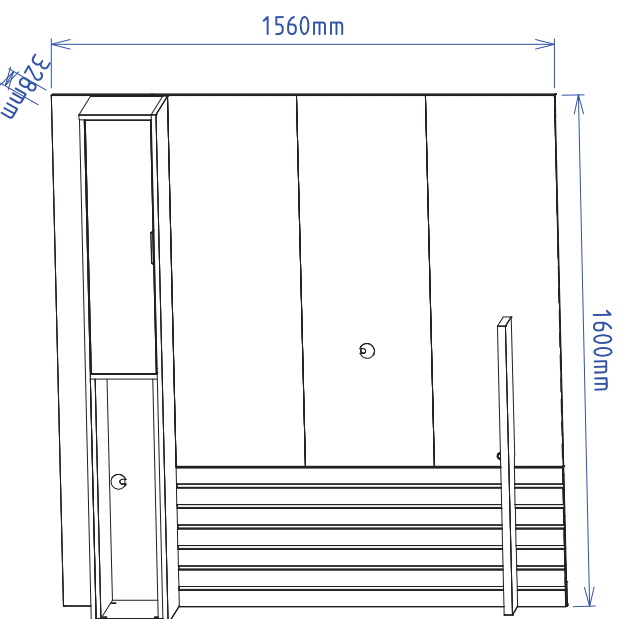

**ATENÇÃO:**  
Fixar TV somente no painel.  
O painel comporta TV de até 60"

