

PRATELEIRA 2.2

V- 2 10/02/23

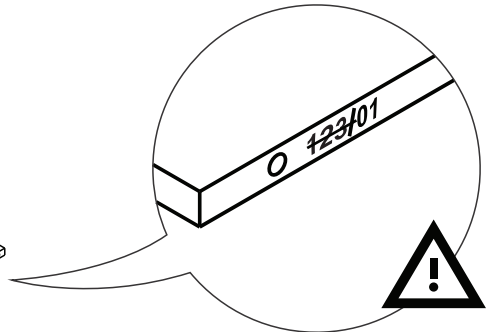
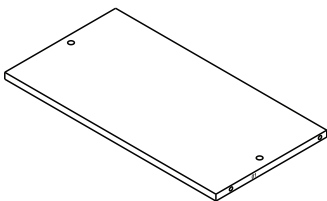
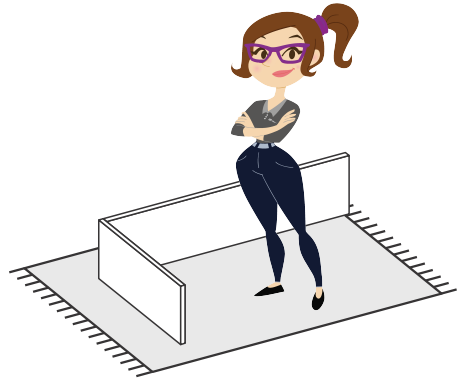
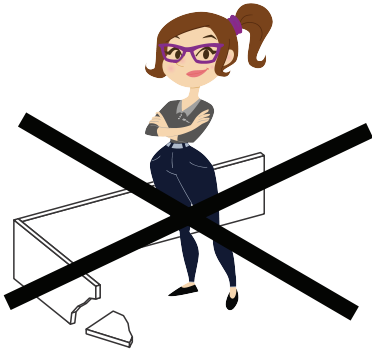
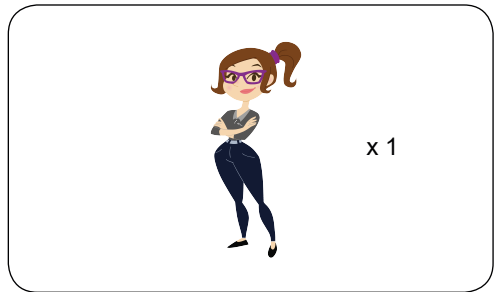
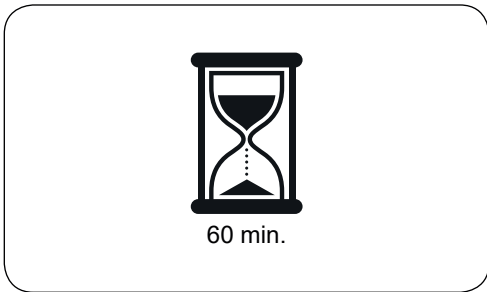
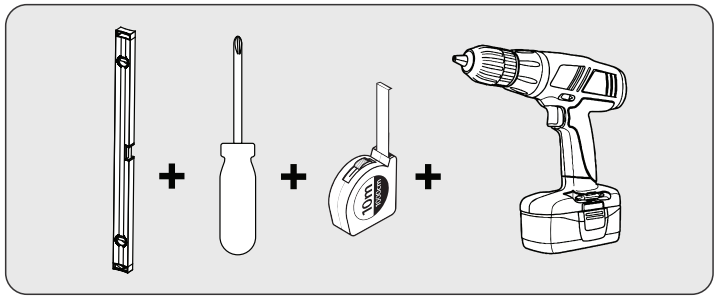
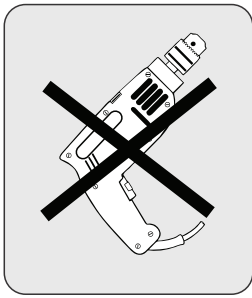

Nossos produtos são garantidos por 90 dias contra defeitos de fabricação. Ao constatar um problema coberto pela garantia, entre em contato com a loja onde o produto foi comprado. Ela estará capacitada para atendê-lo da melhor forma diante de cada caso. Reclamações de garantia somente poderão ser atendidas se o termo de garantia for apresentado no ato de reivindicação, acompanhado de sua nota fiscal de compra.

Nuestros productos están garantidos contra defectos de fabricación por 90 días, a partir de la compra. Ao constatar un problema protegido por la garantía, póngase en contacto con la tienda donde se adquirió el producto. Ella estará capacitada para atenderlo de la mejor manera de acuerdo con cada caso.

Our products are guaranteed against manufacturing defects for 90 days from the date of purchase. When you find a problem covered by the warranty, please contact the store where the product was purchased. The store be able to serve you in the best way in each case.

Exclusões

- Desgaste natural ou danos causados por água, maresia, ferrugem, incêndio, calor, cupins e pragas em geral
- Montagem, manutenção e uso inadequado
- Não cumprimento das recomendações técnicas do esquema
- Montagens e desmontagens após a primeira instalação
- Instalações elétricas e outras afins

Exclusiones

- Desgaste natural o daños causados por agua, maresia, incendios, calor, termitas y plagas en general
- Montaje, mantenimiento y uso inadecuado
- No cumplimiento de las recomendaciones técnicas del esquema
- Montaje y desmontaje después de la primera instalación
- Instalaciones eléctricas y otras afines

Exclusions

- Natural wear or damage caused by water, sea, rust, fire, heat, termites and plagues in general
- Assembly, maintenance and improper use
- Failure to comply with the technical recommendations of the assembly instructions
- Assembly and disassembly after first installation

Importante

A Linea Brasil não autoriza nenhuma pessoa, loja ou entidade assumir em seu nome qualquer outra garantia que não conste no certificado. A fabricante reserva-se no direito de efetuar nos produtos eventuais modificações que considerar necessárias, sem prejudicar as características essenciais. Os produtos terão peças de assistência para reposição no período de 1 ano a contar de sua retirada do mercado, desde que haja matéria-prima equivalente, observando o dispositivo no Art.32 da Lei 8.078/90 (Cód. Defesa do Consumidor). O atendimento para produtos fora de linha é feito por programação especial, através da loja revendedora sob aprovação de consulta prévia ao fabricante.

Importante / Linea Brasil no autoriza a ninguna persona, tienda o entidad a asumir en su nombre cualquier otra garantía que no figure en el certificado. El fabricante se reserva el derecho de efectuar en los productos eventuales modificaciones que considere necesarias, sin perjudicar las características esenciales. Los productos tendrán piezas de asistencia para reposición en el período de 1 año a partir de su retirada del mercado. La atención para productos fuera de línea es hecha por programación especial, a través de la tienda revendedora bajo aprobación de consulta previa al fabricante.

Important / Linea Brasil does not authorize any person, store or entity to assume on its behalf any other warranty that does not appear on the certificate. The manufacturer reserves the right to make in the products any modifications that it considers necessary without prejudice to the essential characteristics. The products will have replacement parts within one year of being withdrawn from the market. The service for off-line products is done by special programming, through the store reseller under prior consultation with the manufacture.

INSTRUÇÕES DE LIMPEZA E CONSERVAÇÃO

CLEAN AND PRESERVATION INSTRUCTURE / INSTRUCCIONES PARA LA LIMPIEZA Y CONSERVACION

Para retirar pó, utilize um pano seco, espanador ou aspirador. Se necessário para uma limpeza mais efetiva, utilize um pano levemente úmido com água. Finalize com uma flanela limpa e seca.

To take dirty, use a dry cloth, duster or vacuum. If necessary to take the dust, use a wet cloth. Finish with a clean and dry flannel.

Para eliminar el polvo, utilice un paño seco, mopa o la aspiradora. Si es necesario para una limpieza más eficaz, con paño ligeramente humedecido con agua. Terminar con un paño limpio y seco.

! IMPORTANTE / IMPORTANT / IMPORTANTE



Não utilize produtos abrasivos como álcool e detergentes, como também esponjas rígidas ou palhas de aço na limpeza dos móveis.

Do not use abrasives such as alcohol and detergent, though soaker also steel wool to clean the furniture.

No use limpiadores abrasivos como alcohol y detergentes, así como esponjas rígidas o lana de acero para limpiar los muebles.



Proteja a superfície do móvel de objetos que transmitam calor ou umidade.

Protect the surface of the furniture against objects that can pass heat and humidity.

Proteja la superficie del mueble de objetos que transmitan calor o humedad.



Evitar o contato de água e produto de limpeza com o rodapé do produto, pois poderá danificá-lo.

Avoid the contact of water and cleaning products with baseboard, cause it should damage your product.

Evitar el contacto con agua y producto de limpieza con el rodapié del producto, pues podrá dañarlo.



Procure sempre utilizar flanela limpa e seca para limpeza.

Try always to use a clean and dry flannel to cleaning.

Busque siempre utilizar franela limpia y seca para la limpieza.

Cuidado com objetos pontiagudos, eles podem arranhar a superfície das portas e tampo.

Take care with sharp objects, they can scratch the door lid surface.

Cuidado con objetos afilados, ellos pueden rayar la superficie de las puertas y la tapa.

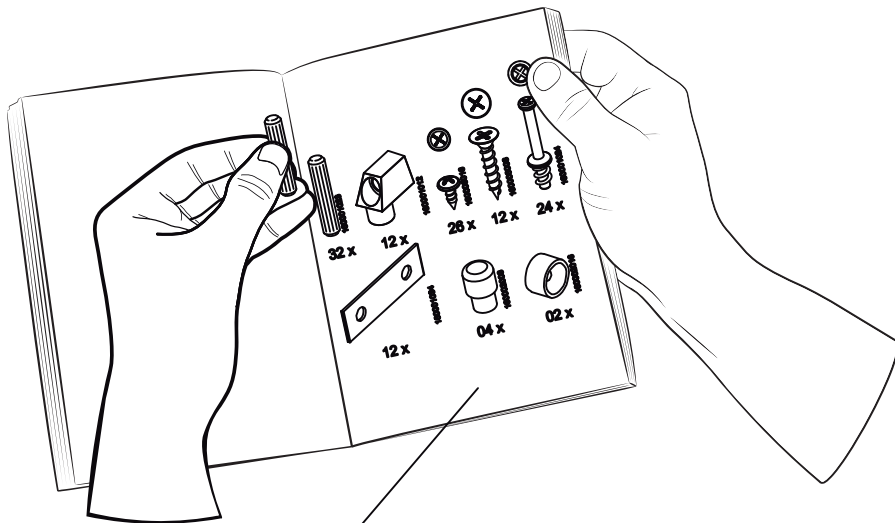

Preste Atenção!
¡Preste atención!
Attention!



As ferragens dos nossos manuais são sempre apresentadas nas mesmas proporções da peça na vida real.
 Caso apareça alguma dúvida no decorrer do processo de montagem, coloque a ferragem ao lado do desenho e faça a consulta :D

Los accesorios de nuestros manuales siempre se presentan en las mismas proporciones que la pieza en la vida real.
 Si tiene alguna duda durante el proceso de montaje, coloque los accesorios junto al dibujo y haga una consulta :D

The accessories in our manuals are always presented in the same proportions as the spare part in real life.
 If you have any questions during the assembly process, place the accessory next to the drawing and make an inquiry :D

Símbolos:
Simbolos:
Symbols:



- + Parafuso Phillips
- Parafuso Fenda
- ⬡ Parafuso Allen
- + Tornillo Phillips
- Tornillo Ranurado
- ⬡ Tornillo Allen
- + Phillips screw
- Slotted Screw
- ⬡ Allen screw



160006008

08 x

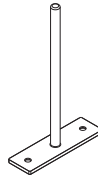

160004003

04 x

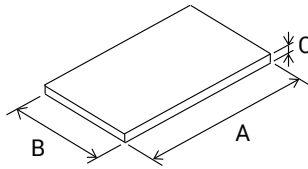

VOLUME Caja Box	ITEM Artículo Item	PEÇA Pieza Part	DESCRIÇÃO Descripción Description	DIMENSÕES (mm) Dimensión/Dimension			QUANTIDADE Cantidad Amount	MATERIAL
				A	B	C		
1	25	510280001	PRATELEIRA	2176	175	37	1	MDP

ARTÍCULO	DESCRIPCIÓN
1	ESTANTE

ITEM	DESCRIPTION
1	SHELF



Atenção! Attention! Atención!

Produto contempla acessórios para instalação no produto PAINEL RIPADO MODULAR (vendido separadamente), conforme indicado no manual de montagem. Adaptações ou montagens fora do especificado no manual de montagem são de responsabilidade do consumidor e implicam na perda de garantia do produto.

This products brings accessories for the product installation to the SLATTED PANEL MODULAR SET (sold separately), as indicated on the assembly instructions. Further adaptations or other ways of assembly beyond what's being specified on the assembly instructions are under customer's responsibility and may result in warranty loss.

Esto producto incluye accesorios para montaje en el producto PANEL EMPARRILLADO MODULAR (se vende por separado), como se indica en el manual de armado. Las adaptaciones o montajes que no estén de acuerdo a lo especificado en el manual de armado, son de responsabilidad del cliente y conllevan pérdidas en la garantía del producto.

2.2

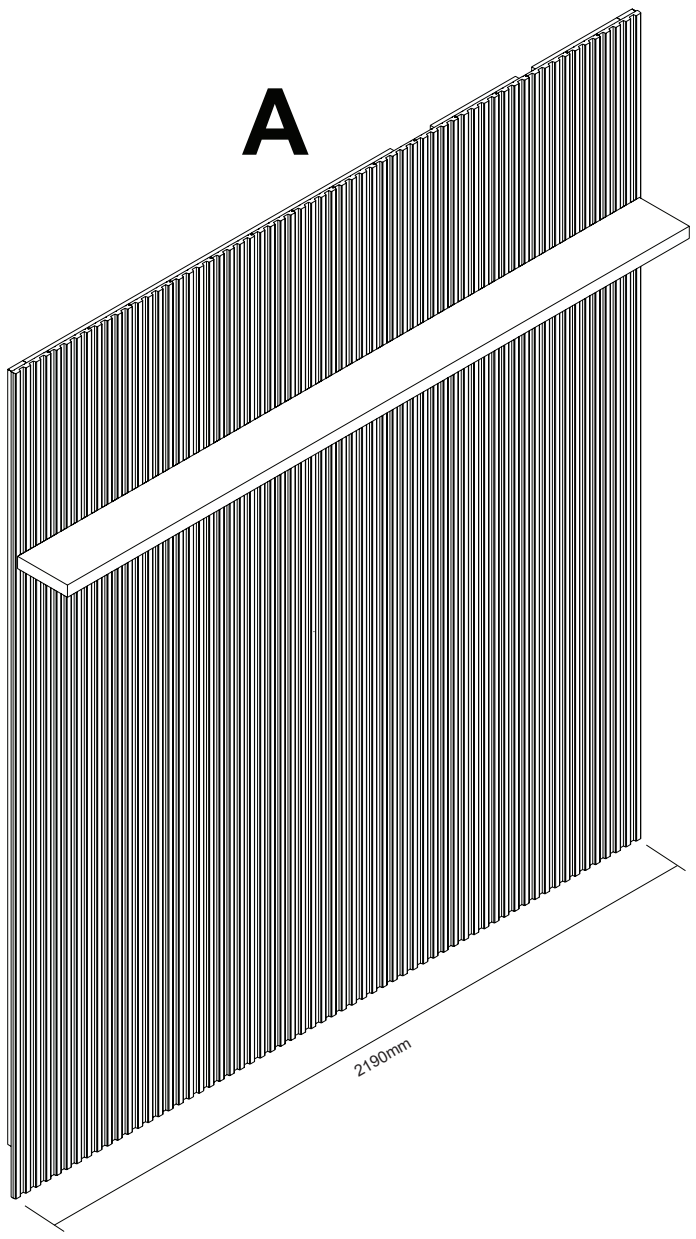

2.6

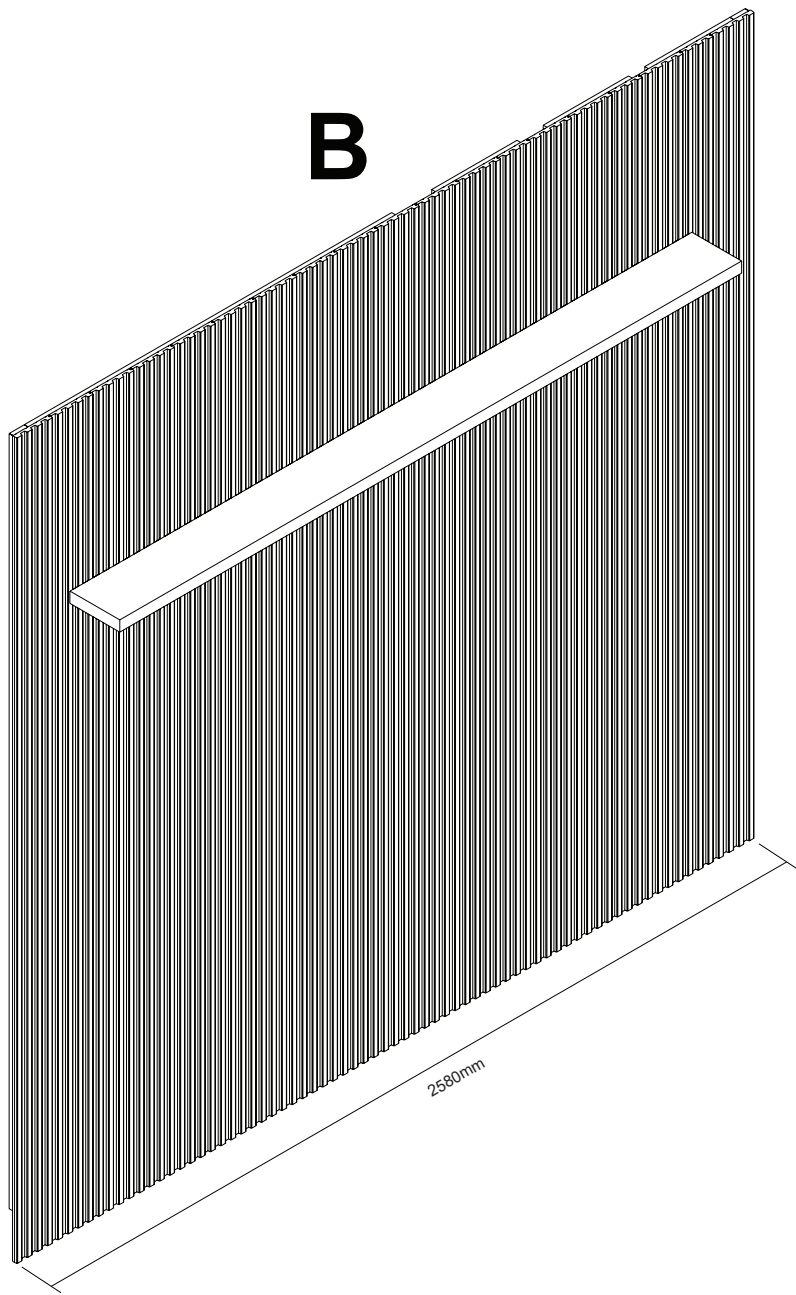

3.0

C

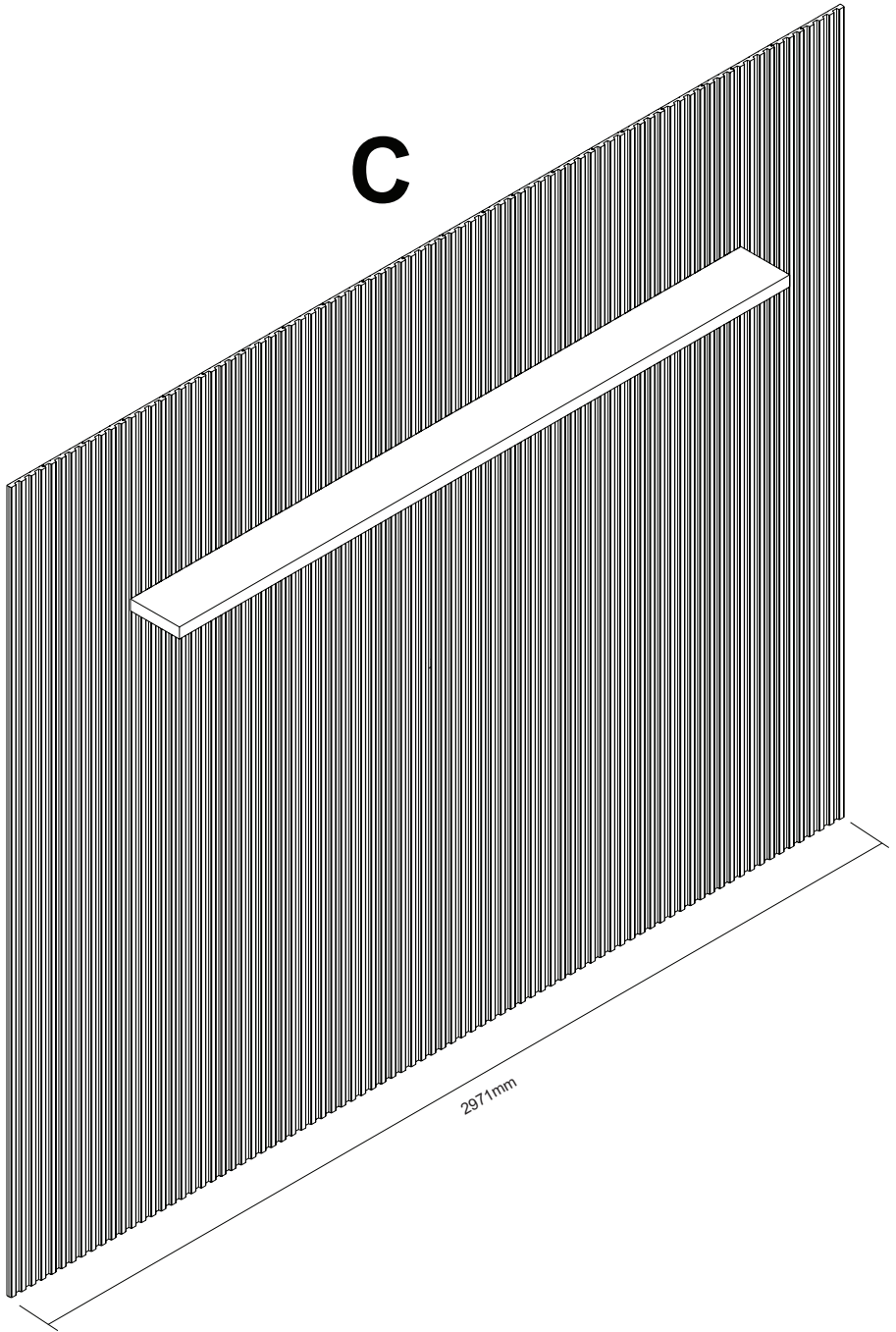

1A

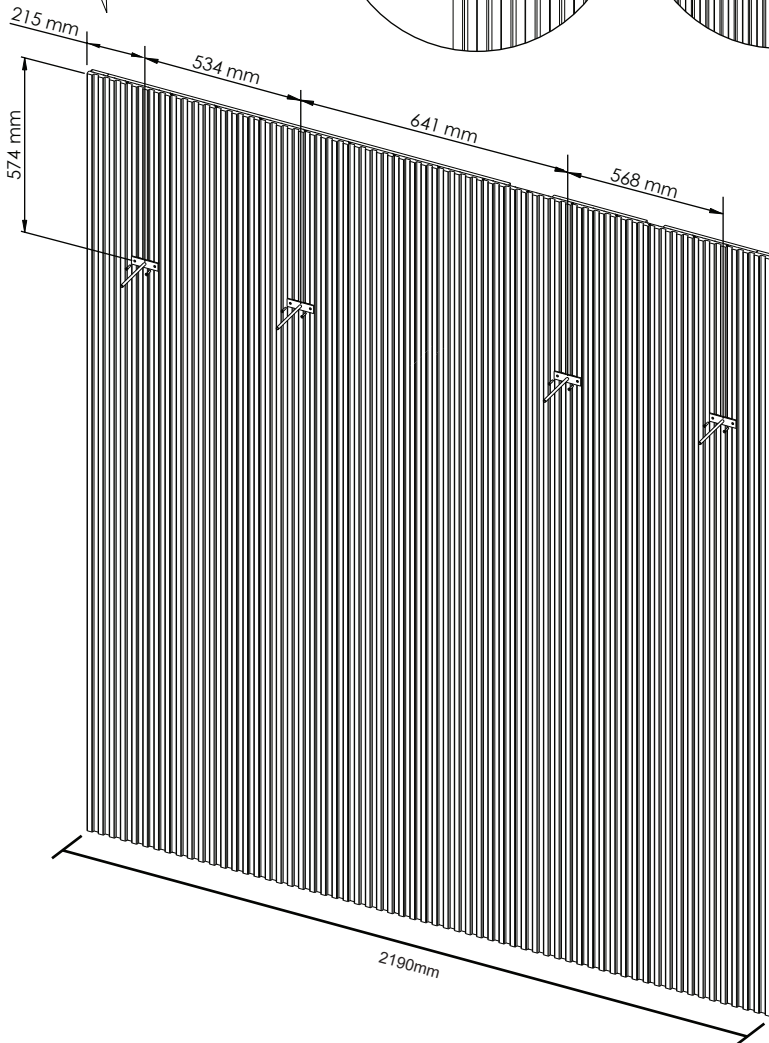
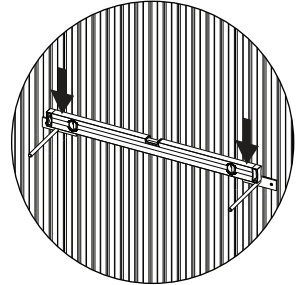
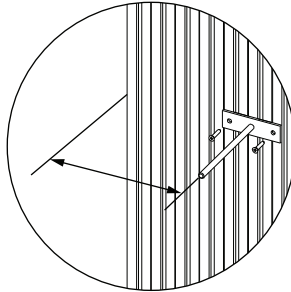
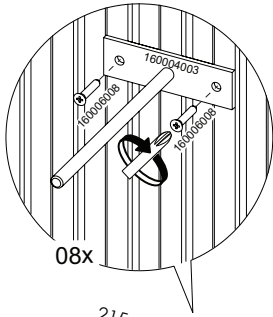
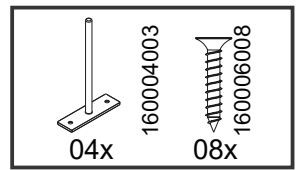

1B

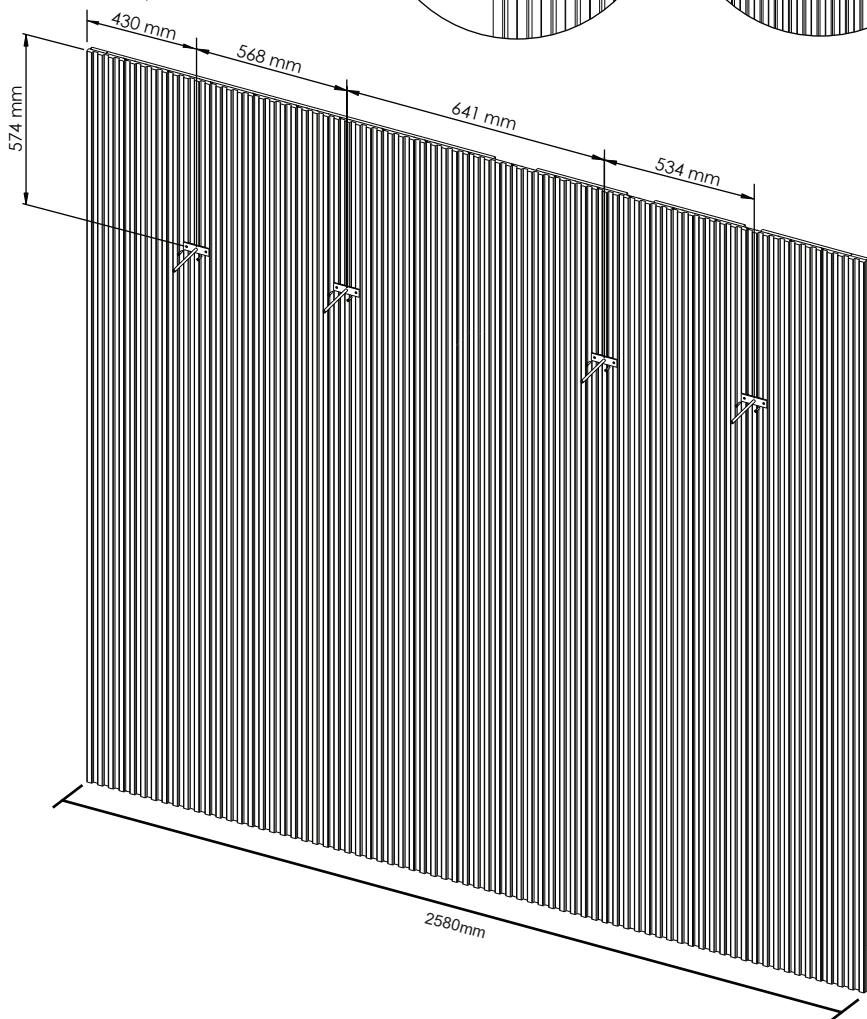
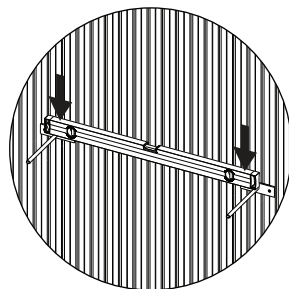
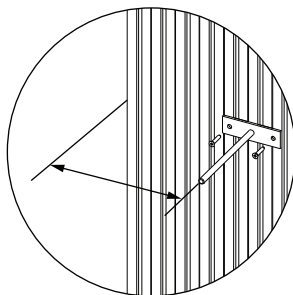
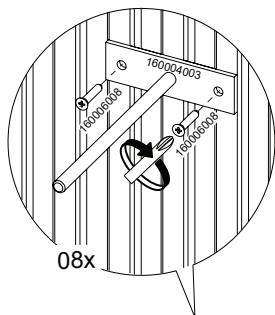
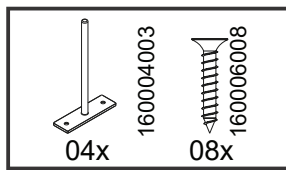

1C

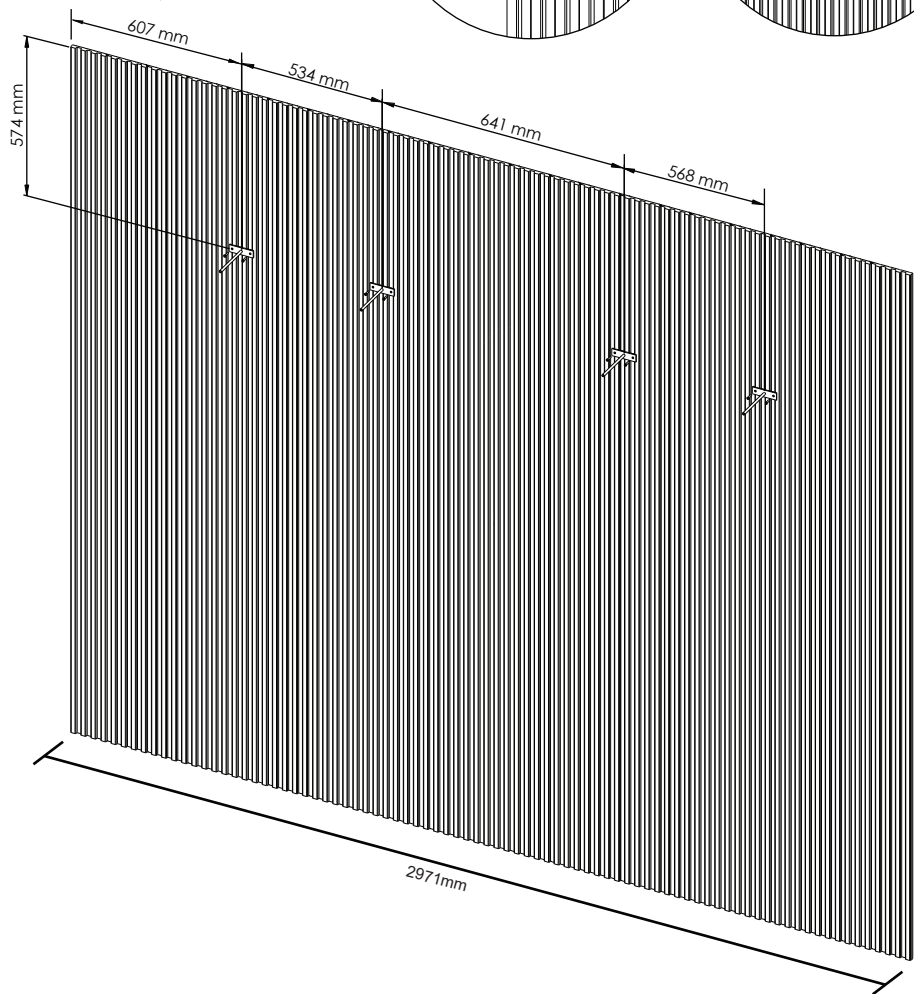
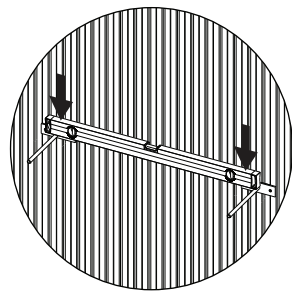
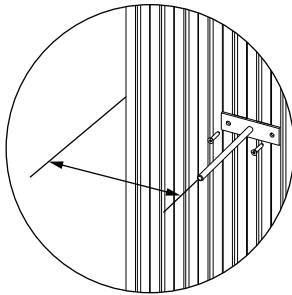
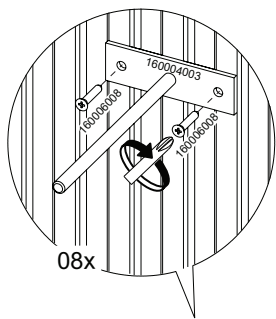
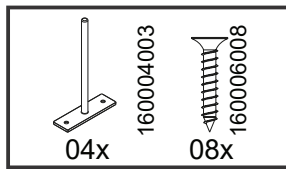

2

