

# CO9103 - PANELEIRO

Manual de Montagem  
Assembly Instructions  
Instrucción de Montaje

decibal<sup>®</sup>  
móveis

Produto Montado  
Producto final  
Assembled

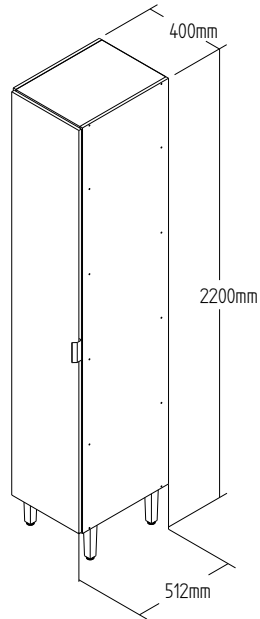

01°

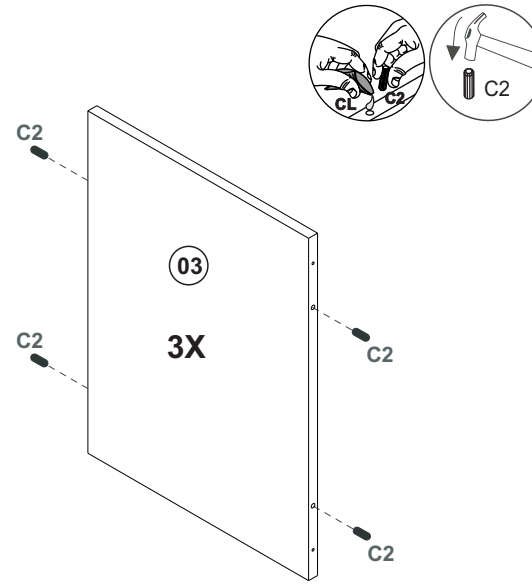

02°

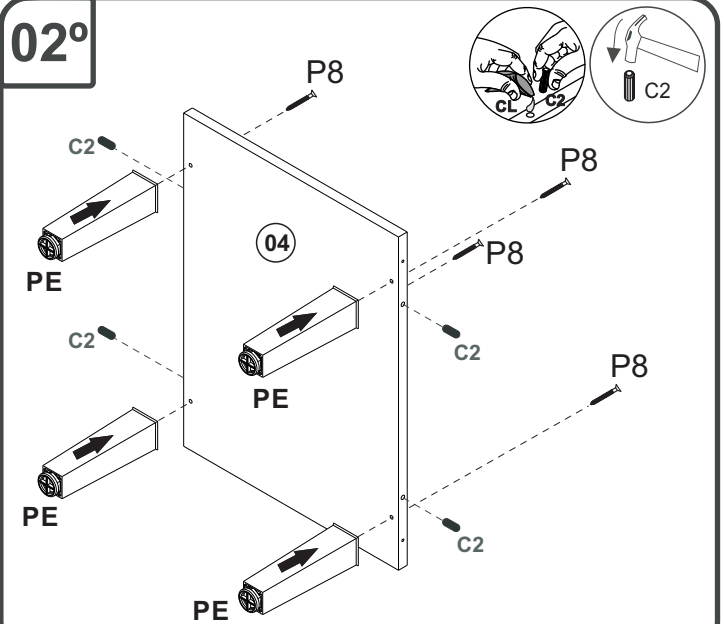

03°

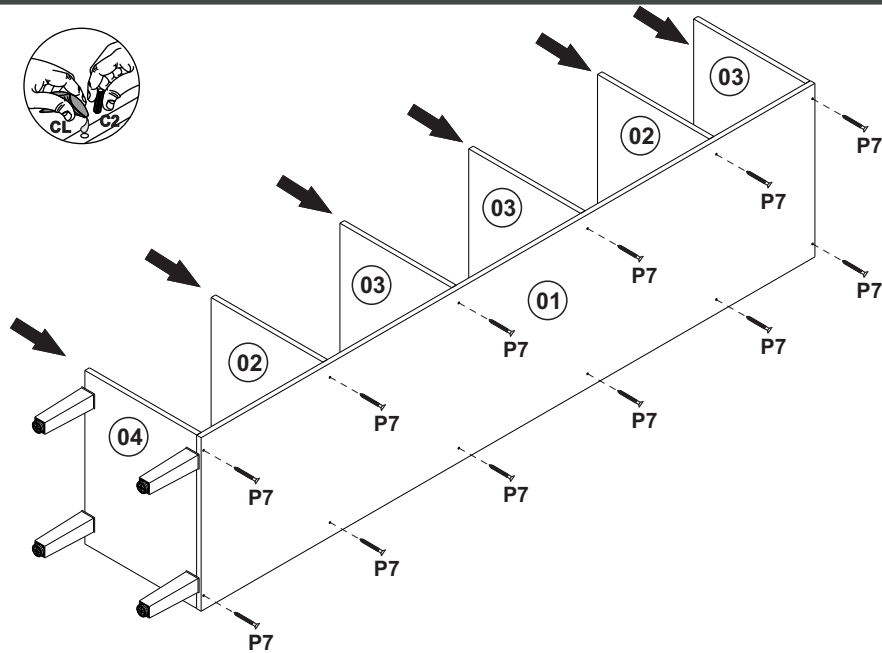

04°

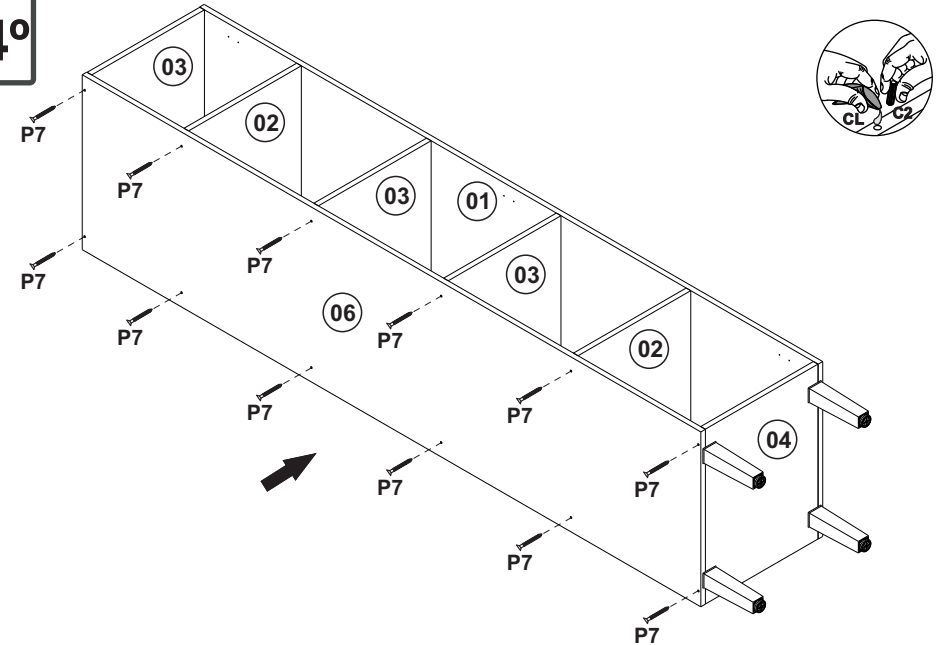

# CO9103 - PANELEIRO

Manual de Montagem  
Assembly Instructions  
Instrucción de Montaje

decibal<sup>®</sup>  
móveis

05°

COSTA/REVÉS/BACK

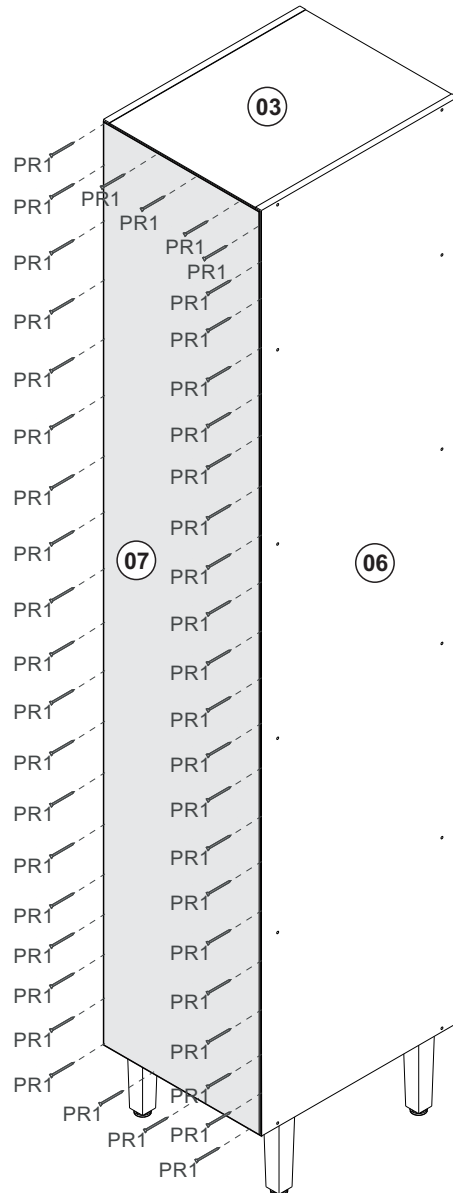
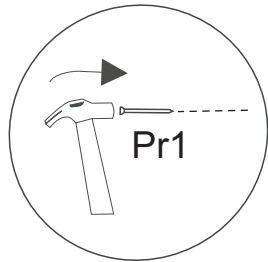

06°

PESO SUPORTADO/PESO SOPORTADO/WEIGHT SUPPORTED



# CO9103 - PANELEIRO

Manual de Montagem  
Assembly Instructions  
Instrucción de Montaje

**decibal**<sup>®</sup>  
móveis

7°

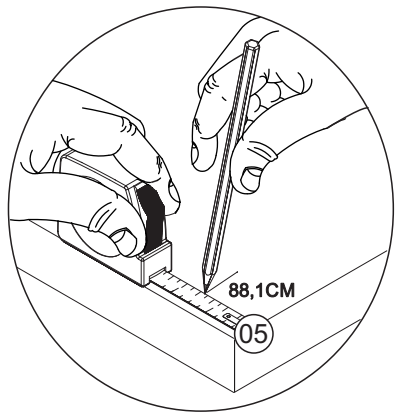
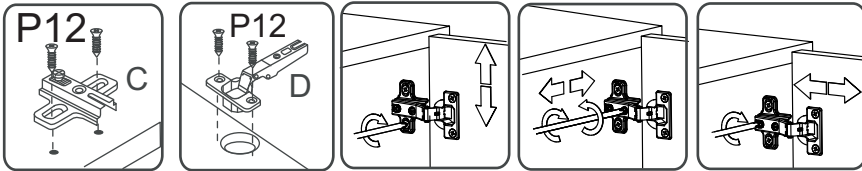

**ATENÇÃO!!!!**





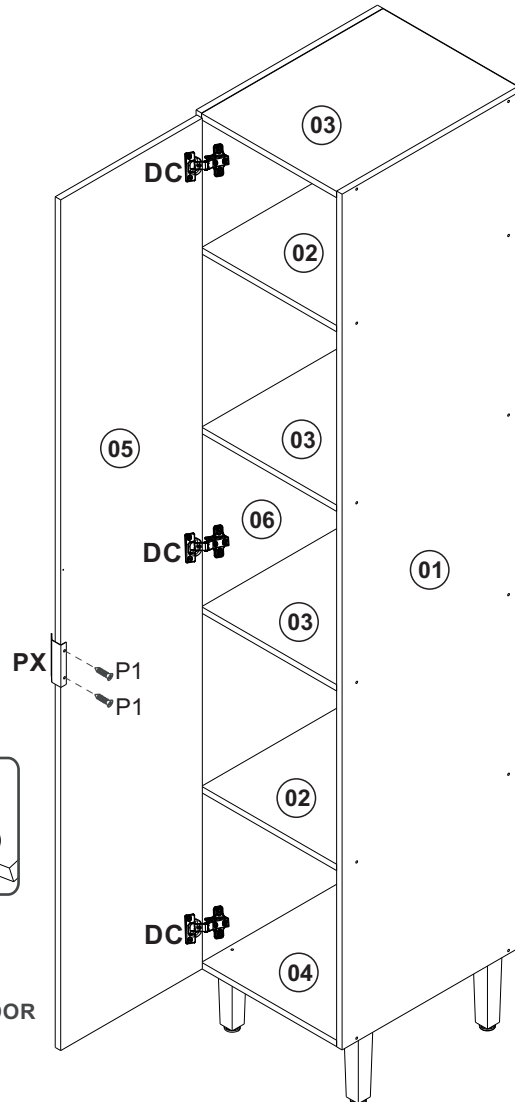

MARCAÇÃO PRA O PRIMEIRO FURO DO PUXADOR

MARCADO PARA EL PRIMER AGUJERO

MARKING FOR THE FIRST HANDLE HOLE

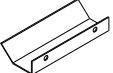

escala (N/A)

| LEGENDA   | DESCRIÇÃO/DESCRIPCIÓN/DESCRIPTION  | CÓDIGO        | QUANT.    |
|-----------|--|---------------|-----------|
| <b>CL</b> |  COLA/PEGAMENTO/GLUE                            | 01213         | <b>01</b> |
| <b>ET</b> |  ETIQUETA LOGO DECIBAL/LABEL DECIBAL            | 01312         | <b>01</b> |
| <b>AD</b> |  ADESIVO/ADHESIVO/ADHESIVE                      | (GRISEO)11895 | <b>25</b> |
| <b>PX</b> |  PUXADOR/PEGADOR /HANDLE (MOV410 /100MM)        | 11440         | <b>01</b> |
| <b>BT</b> |  BATENTE/BATIENTE DE SILICONA/SILICONE STOP 8MM | 02921         | <b>02</b> |
| <b>DC</b> |  DOBRADIÇA/BISAGRA/HINGE D=35mm C=0             | 09449         | <b>03</b> |
| <b>PE</b> |  PÉ/PATA/FOOT (170MM)                          | 11121         | <b>04</b> |

## Ferragens/ Herrajes/ Hardware escala (1:1)

| LEGENDA    | DESCRIÇÃO/DESCRIPCIÓN/DESCRIPTION  | CÓDIGO | QUANT.    |
|------------|--|--------|-----------|
| <b>P7</b>  | <br>PARAFUSO/TORNILLO/SCREW 4X45                    | 01318  | <b>24</b> |
| <b>PR1</b> | <br>PREGO/CLAVO/NAIL 10X10                          | 01330  | <b>60</b> |
| <b>C2</b>  | <br>CAVILHA/TARUGO/DOWEL 6X30 MM                    | 01211  | <b>17</b> |
| <b>P12</b> | <br>PARAFUSO/TORNILLO/SCREW 3,5X13 CABEÇA FLANGEADA | 09927  | <b>12</b> |
| <b>P1</b>  | <br>PARAFUSO/TORNILLO/SCREW 3,5X12                  | 01328  | <b>02</b> |
| <b>P8</b>  | <br>PARAFUSO/TORNILLO/SCREW 5X45                    | 01320  | <b>04</b> |
| <b>PU</b>  | <br>PARAFUSO UNIÃO/UNIÓN DETORNILLO /SCREW UNION   | 01495  | <b>02</b> |

## Relação de Peças/ Relación de Piezas/Parts List

| Nº | CÓDIGO/ CODE | DESCRIÇÃO/ DESCRIPCIÓN/ DESCRIPTION    | QTD/ CANT | VOL. |
|----|--------------|--|-----------|------|
| 1  | 0548820      | LATERAL DIR/LATERAL/SIDE 2030X497X15MM | 1,00      | 1    |
| 2  | 0549156      | PRATELEIRA/ESTANTE/SHELF 497X370X15MM  | 2,00      | 1    |
| 3  | 0548819      | BASE 497X370X15MM                      | 3,00      | 1    |
| 4  | 0548663      | BASE INF 497X370X15MM                  | 1,00      | 1    |
| 5  | 0548823      | PORTA/PUERTA/DOOR 2018X388X15MM        | 1,00      | 1    |
| 6  | 0548821      | LATERAL ESQ/LATERAL/SIDE 2030X497X15MM | 1,00      | 1    |
| 7  | 0548822      | COSTA/REVÉS/BACK 2124X394X2,8MM        | 2,00      | 2    |

**ATENÇÃO!!!! montadores e consumidores**  
\* Ajustar o torque da parafusadeira para não danificar as peças escareando o parafuso \*

**ATENCIÓN!!!! montadores e consumidores**  
\* Ajuste el torque del destornillador para no dañar las piezas avallando el tornillo \*



**ATTENTION!!!! assemblers and consumers**  
\* Adjust the torque of the screwdriver so as not to damage the parts by countersinking the screw \*

Ferramenta necessária  
Necessary tools  
Herramientas necesarias



**ATENÇÃO!!!! montadores e consumidores**  
\* Para limpar o móveis utilize somente um pano úmido (umedecido em água pura ou água com sabão neutro). Depois, passe um pano seco. Evite a umidade excessiva.  
\* Evite usar álcool, água sanitária, detergente e outros produtos químicos, mesmo diluídos em água. Não utilize produtos abrasivos de nenhuma espécie

**ATENCIÓN!!!! montadores e consumidores**  
\* Para limpiar el mueble utilice solamente un paño húmedo (humedecido con agua limpia o con un jabón suave). A continuación, utilice un paño seco. Evite el exceso de humedad.  
\* Evite uso de alcohol, hipoclorido solución basada, detergente y otros productos químicos, mismo diluídos en agua. No utilice productos abrasivos de ningún tipo.  
**ATTENTION!!!! assemblers and consumers**  
\* To clean the furniture, use only a damp cloth (humidify it only in pure water ou water and neutral soap).After, use a dry cloth.Avoid excessive humidity.  
\* Avoid using alcohol, bleach, detergent and other chemical productos, even diluted in water. Do not use any kind of abrasive cleaning agentes to clean the furniture.  
The use of such products may jeopardize the ?nal characteristics of the furniture.

 60 min.
  1 montador  
1 ajustador  
1 Fitter

[www.decibal.com.br](http://www.decibal.com.br)

