

CO14103 - PANELEIRO

Manual de Montagem
 Assembly Instructions
 Instrucción de Montaje

decibal[®]
 móveis

Produto Montado
 Producto final
 Assembled

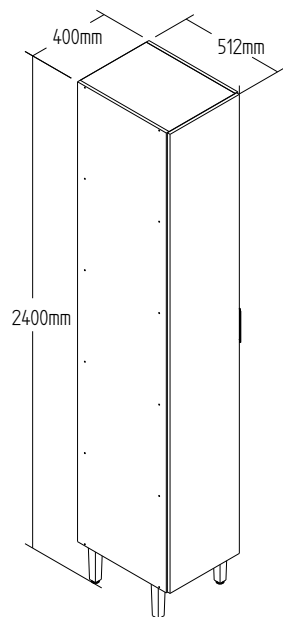

01°

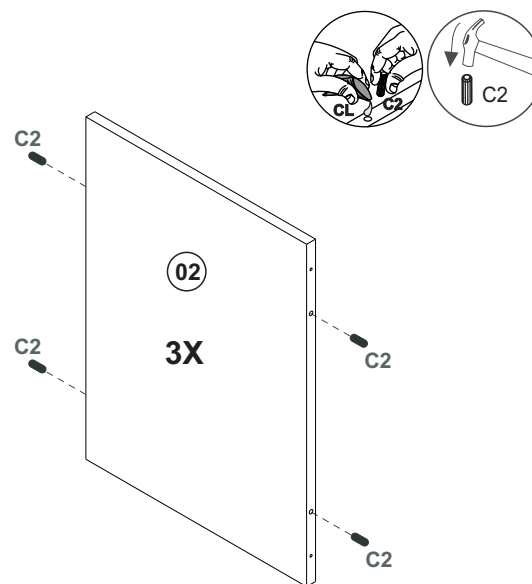

02°

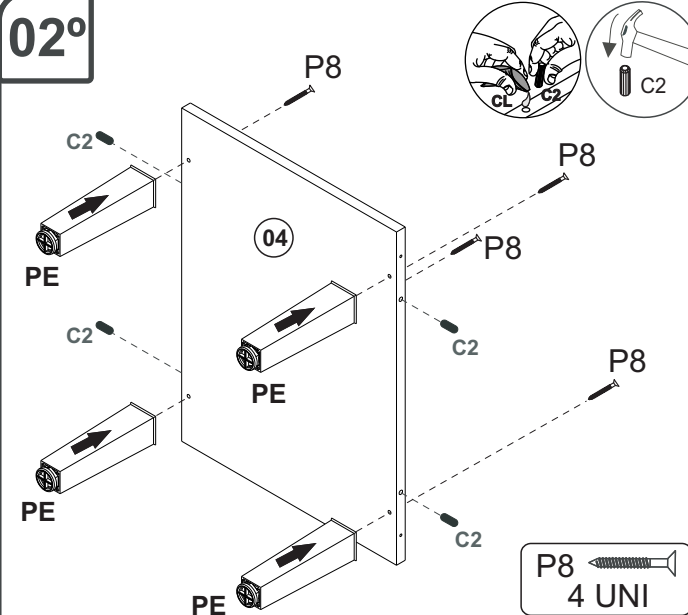

03°

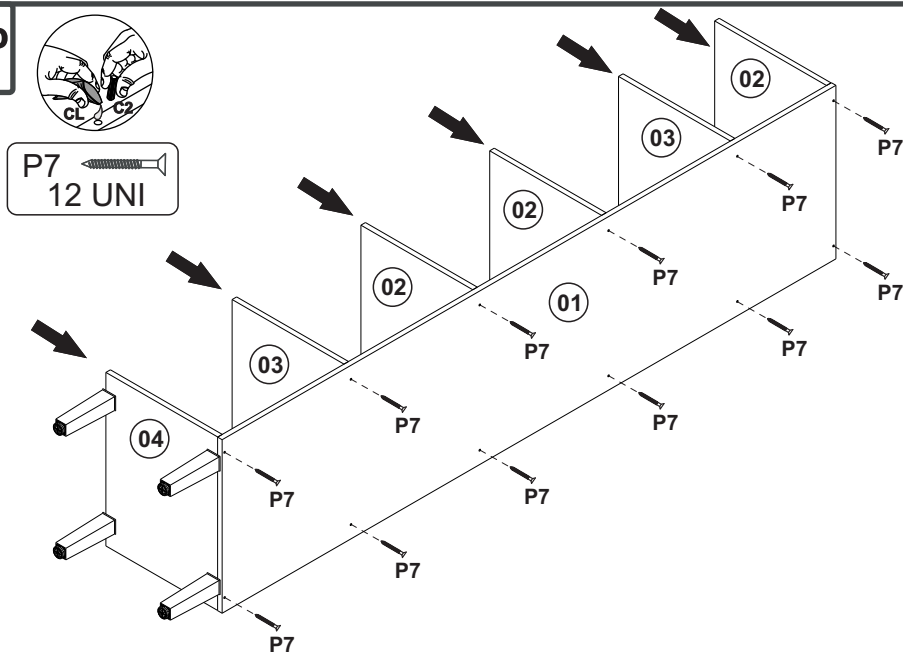

04°

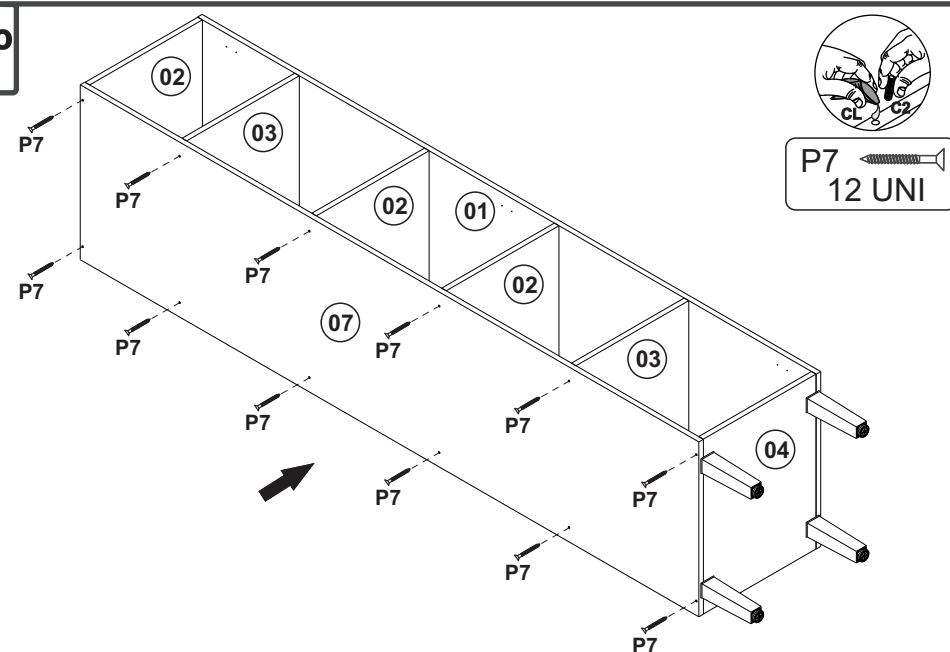

CO14103 - PANELEIRO

Manual de Montagem
Assembly Instructions
Instrucción de Montaje

decibal[®]
móveis

05°

COSTA/REVÉS/BACK

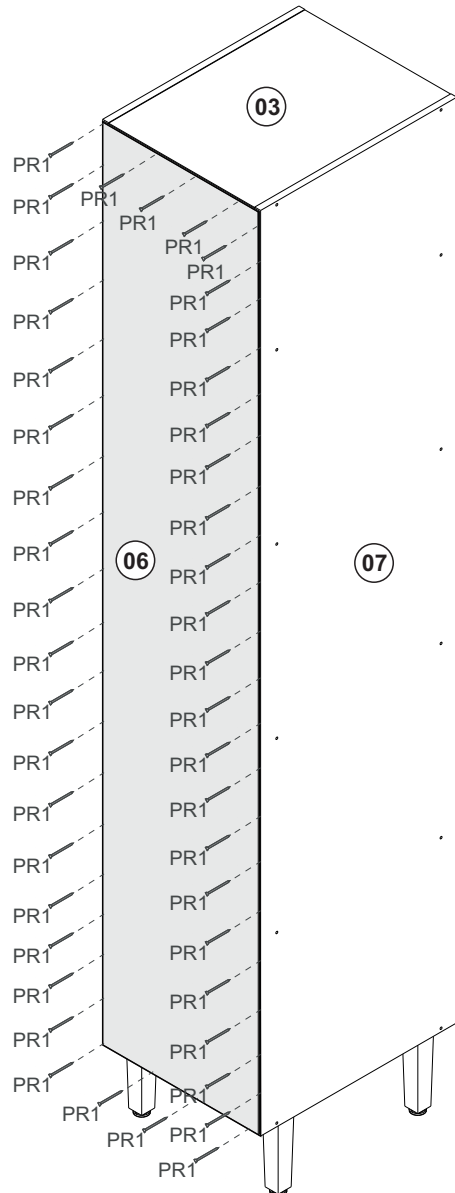
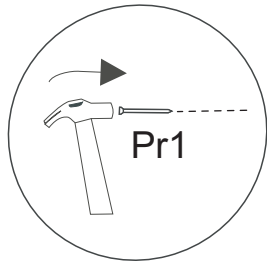

06°



*PESO SOPORTADO.
*PESO SOPORTADO.
*WEIGHT SUPPORTED.



CO14103 - PANELEIRO

Manual de Montagem
Assembly Instructions
Instrucción de Montaje

decibal[®]
móveis

7°

ATENÇÃO!!!!

MARCAÇÃO PRA O PRIMEIRO FURO DO PUXADOR
MARCADO PARA EL PRIMER AGUJERO
MARKING FOR THE FIRST HANDLE HOLE

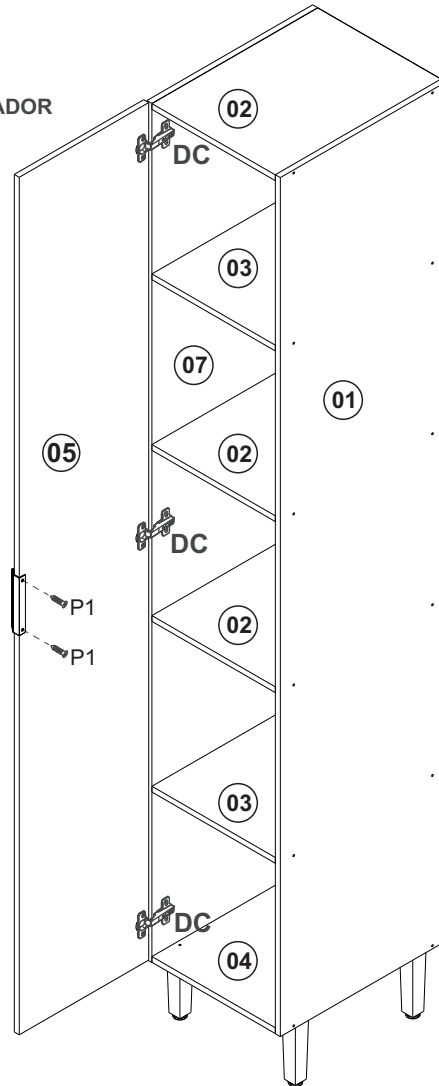
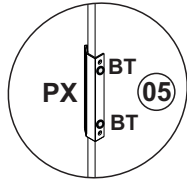
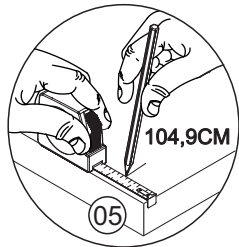

Relação de Peças/ Relación de Piezas/Parts List

N°	CÓDIGO/CODE	DESCRIÇÃO/DESCRIPCIÓN/DESCRIPTION	QTD/CANT	VOL.
1	0560973	LATERAL DIR/LATERAL/SIDE 2230X497X15MM	1,00	1
2	0560974	BASE 497X370X15MM	3,00	1
3	0560975	PRATELEIRA/ESTAMTE/SHELF 497X370X15MM	2,00	1
4	0560972	BASE INF 497X370X15MM	1,00	1
5	0560976	PORTA/PUERTA/DOOR 2226X388X15MM	1,00	1
6	0560977	COSTA/REVÉS/BACK 2224X394X2,8MM	1,00	1
7	0560973	LATERAL ESQ/LATERAL/SIDE 2230X497X15MM	1,00	1

www.decibal.com.br

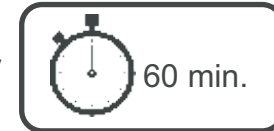

ATENÇÃO!!!! montadores e consumidores
* Ajustar o torque da parafusadeira para não danificar as peças escareando o parafuso *
ATENCIÓN!!!! montadores e consumidores
* Ajuste el torque del destornillador para no dañar las piezas avallando el tornillo *
ATTENTION!!!! assemblers and consumers
* Adjust the torque of the screwdriver so as not to damage the parts by countersinking the screw *

Ferramentas necessárias
Necessary tools
Herramientas necesarias

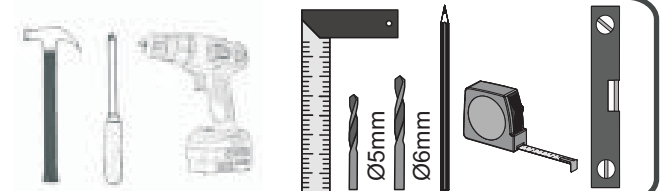

ATENÇÃO!!!! montadores e consumidores
* Para limpar o móveis utilize somente um pano úmido (umedecido em água pura ou água com sabão neutro). Depois, passe um pano seco. Evite a umidade excessiva.
* Evite usar álcool, água sanitária, detergente e outros produtos químicos, mesmo diluídos em água. Não utilize produtos abrasivos de nenhuma espécie

ATENCIÓN!!!! montadores e consumidores
* Para limpiar el mueble utilice solamente un paño húmedo (humedecido con agua limpia o con un jabón suave). A continuación, utilice un paño seco. Evite el exceso de humedad.
* Evite uso de alcohol, hipoclorídoro solución basada, detergente y otros productos químicos, mismo diluidos en agua. No utilice productos abrasivos de ningún tipo.

ATTENTION!!!! assemblers and consumers
* To clean the furniture, use only a damp cloth (humidify it only in pure water or water and neutral soap). After, use a dry cloth. Avoid excessive humidity.
* Avoid using alcohol, bleach, detergent and other chemical products, even diluted in water. Do not use any kind of abrasive cleaning agents to clean the furniture.
The use of such products may jeopardize the ?nal characteristics of the furniture.

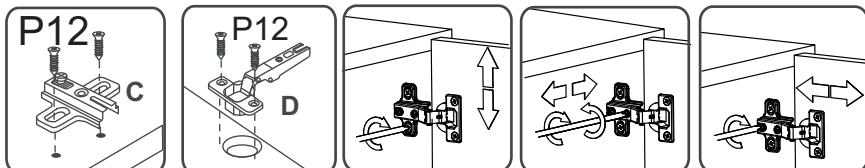







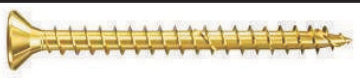

CO14103 - PANELEIRO









Manual de Montagem
Assembly Instructions
Instrucción de Montaje

decibal[®]
móveis

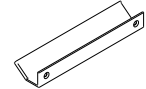
Ferragens/ Herrajes/ Hardware escala (1:1)

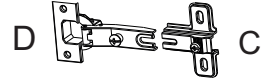
LEGENDA	DESCRIÇÃO/DESCRIPCIÓN/DESCRIPTION	CÓDIGO	QUANT.
P7	 PARAFUSO/TORNILLO/SCREW 4X45	01318	24
PR1	 PREGO/CLAVO/NAIL 10X10	01330	70
C2	 CAVILHA/TARUGO/DOWEL 6X30 MM	01211	18
P12	 PARAFUSO/TORNILLO/SCREW 3,5X13 CABEÇA FLANGEADA	09927	22
P1	 PARAFUSO/TORNILLO/SCREW 3,5X12	01328	02
P8	 PARAFUSO/TORNILLO/SCREW 5X45	01320	04
PU	 PARAFUSO UNIÃO/UNIÓN DETORNILLO /SCREW UNION	01495	02
P9	 PARAFUSO/TORNILLO/SCREW 6X50	03827	02

escala (N/A)

LEGENDA	DESCRIÇÃO/DESCRIPCIÓN/DESCRIPTION	CÓDIGO	QUANT.
CL	 COLA/PEGAMENTO/GLUE	01213	01
ET	 ETIQUETA LOGO DECIBAL/LABEL DECIBAL	01312	01
AD	 ADESIVO/ADHESIVO/ADHESIVE	15mm	24
PX	 PUXADOR/PEGADOR /HANDLE CHAMPANHE(AKEO 128MM)	12611	01
BT	 BATENTE/BATIENTE DE SILICONA/SILICONE STOP 8MM	02921	02
DC	 DOBRADIÇA/BISAGRA/HINGE D=35mm C=ALTO (AMORTECIMENTO)	12615	03
PE	 PÉ/PATA/FOOT (170MM)	12003	04
S5	 SUPORTE AÉREO/APOYO AÉREO/AIR SUPPORT	03828	02
B8	 BUCHA / BUJE / BUCHING 8 MM	01311	02

