

AC4004 - KIT COZINHA

Manual de Montagem Assembly Instructions Instrucción de Montaje

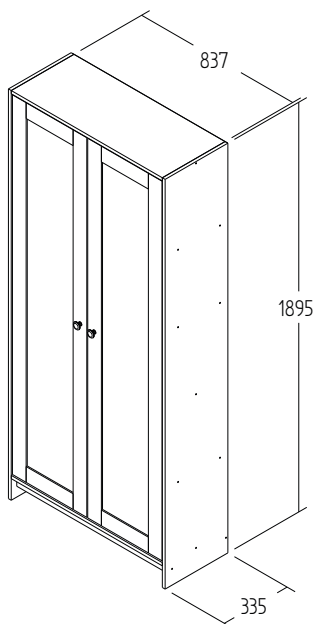

Produto Montado
Producto final
Assembled



1º

P7
11 UN

C2
07 UN

B
09 UN

2º

P7
11 UN

C2
07 UN

B
09 UN

3º

P12

Ct1

P12

Ct1
04 UN

P12
08 UN

4º

FX
28 UN

Pr1
88 UN

ATENÇÃO!!!! montadores e consumidores
* Ajustar o torque da parafusadeira para não danificar as peças escareando o parafuso *

ATENCIÓN!!!! montadores e consumidores
* Ajuste el torque del destornillador para no dañar las piezas avallanando el tornillo *

ATTENTION!!!! assemblers and consumers
* Adjust the torque of the screwdriver so as not to damage the parts by countersinking the screw

Ferramente necessárias
Necessary tools
Herramientas necesarias

60 min.

2 montador
2 ajustador
2 Fitter

www.decibal.com.br

ATENÇÃO!!!! montadores e consumidores
* Para limpar o móveis utilize somente um pano úmido (umedecido em água pura ou água com sabão neutro). Depois, passe um pano seco. Evite a umidade excessiva.
* Evite usar álcool, água sanitária, detergente e outros produtos químicos, mesmo diluídos em água. Não utilize produtos abrasivos de nenhuma espécie

ATENCIÓN!!!! montadores e consumidores
* Para limpiar el mueble utilice solamente un paño húmedo (humedecido con agua limpia o con un jabón suave). A continuación, utilice un paño seco. Evite el exceso de humedad.
* Evite uso de alcohol, hipoclorito solución basada, detergente y otros productos químicos, mismo diluídos en agua. No utilice productos abrasivos de ningún tipo.

ATTENTION!!!! assemblers and consumers
* To clean the furniture, use only a damp cloth (humidify it only in pure water or water and neutral soap). After, use a dry cloth. Avoid excessive humidity.
* Avoid using alcohol, bleach, detergent and other chemical products, even diluted in water. Do not use any kind of abrasive cleaning agents to clean the furniture.
The use of such products may jeopardize the final characteristics of the furniture.

AC4004 - KIT COZINHA

Manual de Montagem
Assembly Instructions
Instrucción de Montaje



4°

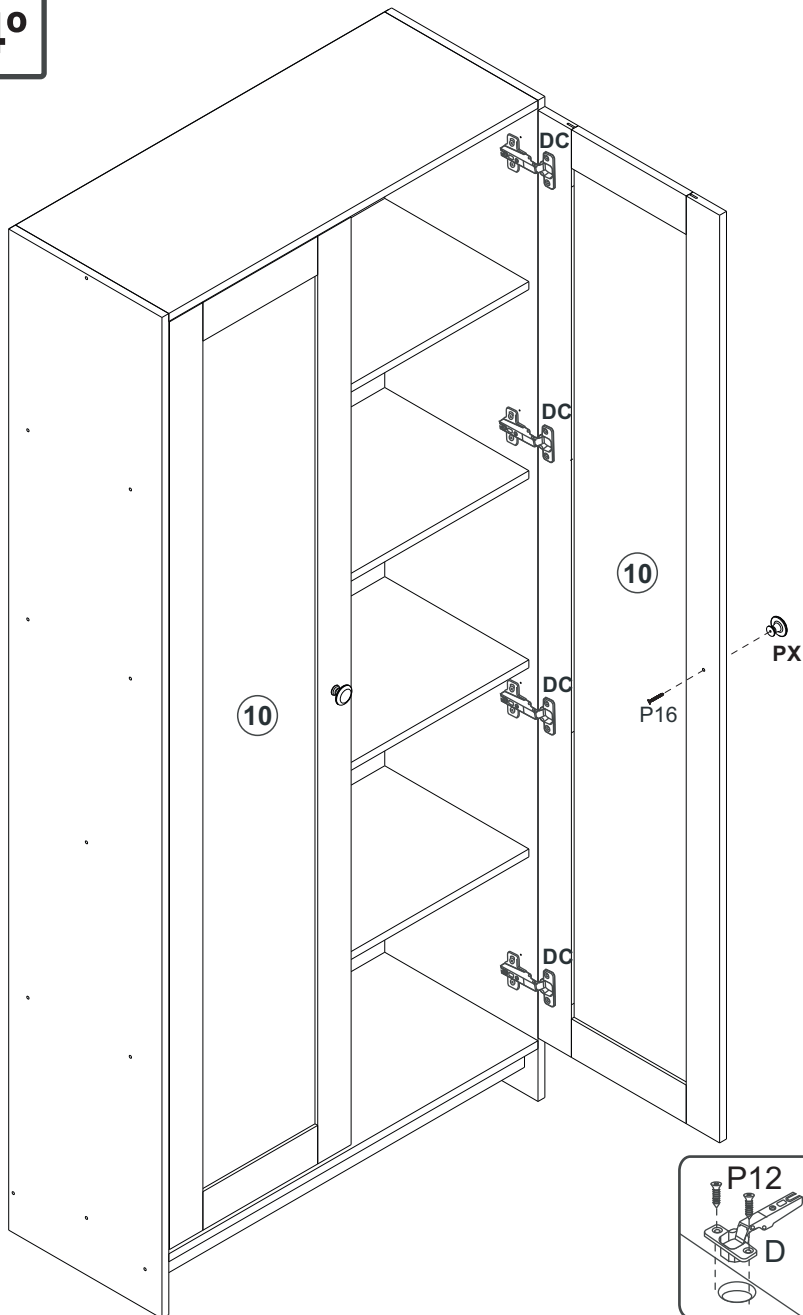

 P12
32 UN

 Dc1
08 UN

 P5
02 UN

 PX
02 UN

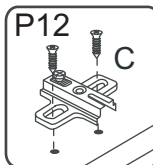
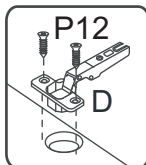
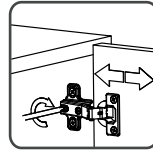
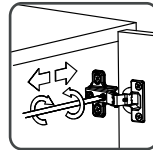
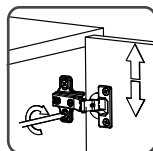

5°

PESO SUPORTADO/PESO SOPORTADO/ WEIGHT SUPPORTED

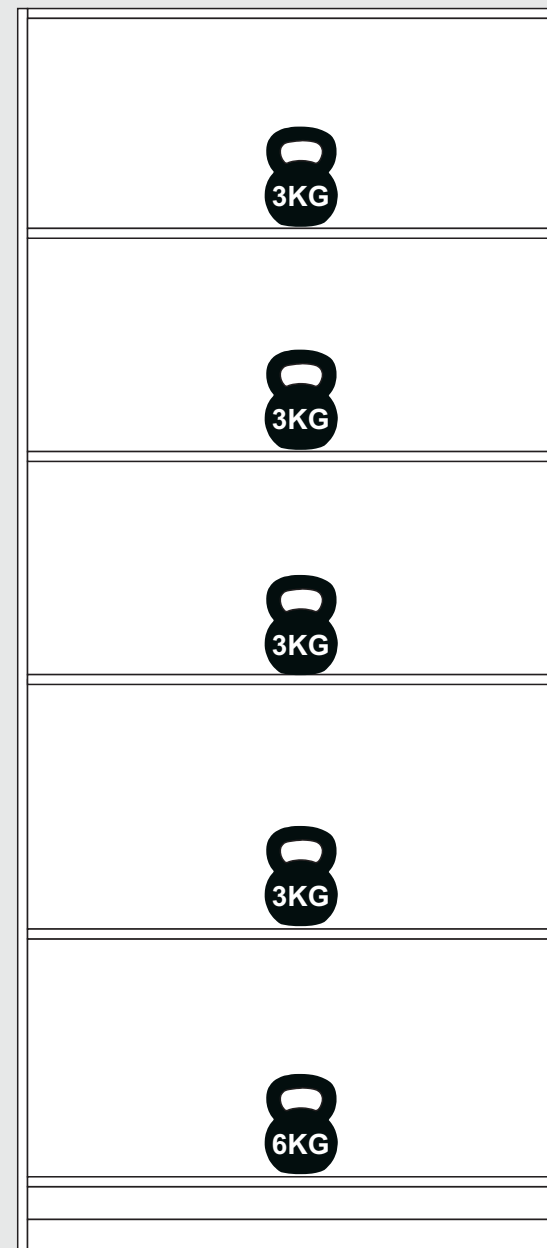

AC4004 - KIT COZINHA

Manual de Montagem
Assembly Instructions
Instrucción de Montaje

decibal[®]
móveis









Relação de Peças/ Relación de Piezas/Parts List

N°	CÓDIGO/CODE	DESCRIÇÃO/DESCRIPCIÓN/DESCRIPTION	QTD/CANT	VOL.
1	0541404	LATERAL DIR SUP/LATERAL/SIDE 1895X335X15MM	1	1
2	0541406	BASE INF 807X335X15MM	1	1
3	0541714	BASE SUP 807X335X15MM	1	1
4	0541717	BASE MEIO 807X315X15MM	1	1
5	0541715	PRATELEIRA/ESTANTE/SHELF 807X335X15MM	3	1
6	0541407	RODAPÉ TRS/ZÓCALO/BASEBOARD 807X100X15MM	1	1
7	0541713	TRAVESSA INF/PLATTER/PLATO 807X50X15MM	1	1
8	0541405	LATERAL ESQ/LATERAL/SIDE 1895X335X15MM	1	1
9	0541712	COSTA/REVÉS/BACK 831X358X2,8MM	5	1
10	0541716	PORTA MOLDURA/PUERTA/DOOR 1756X397X15MM	2	1

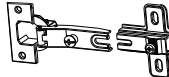
Escala (1:1)

LEGENDA	DESCRIÇÃO/DESCRIPCIÓN/DESCRIPTION	CÓDIGO	QUANT.
P7	 PARAFUSO/TORNILLO/SCREW 4X45	01318	22
Pr1	 PREGO/CLAVO/NAIL 10X10	01330	94
C2	 CAVILHA/TARUGO/DOWEL 6X30 MM	01211	14
B	 BUCJA/BUJE/BUCHING	02734	22
P16	 PARAFUSO/TORNILLO/SCREW 3,5X25	09955	02
P12	 PARAFUSO/TORNILLO/SCREW 3,5X13	09927	44

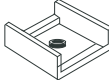
Escala (N/A)

LEGENDA	DESCRIÇÃO/DESCRIPCIÓN/DESCRIPTION	CÓDIGO	QUANT.
CL	 COLA/PEGAMENTO/GLUE	01213	01
Ct1	 CANTONEIRA/PIEZA L/SHEET	03077	05
DC	 DOBRADIÇA/BISAGRA/HINGE D=26mm C=5mm	01657	08
PX	 PUXADOR/PEGADOR/HANDLE	07388	02
ET	 ETIQUETA LOGO DECIBAL/LABEL DECIBAL	01312	01
FX	 FIXADOR COSTA/FIJADOR FONDO/FIXER COAST	01331	28
BT	 BATENTE SILICONE/ TOPE DE SILICONA/ SILICONE STOPPER	02924	04
Pe1	 PÉ/PATA/FOOT	01367	06
AD	 ADESIVO/ADHESIVO/ADHESIVE	15MM	22

Medida em mm

