



mxmóveis

Rodovia SC-492 - Km 10 - B. Industrial
89905-000 - Bandeirante - SC
Fone: (49) 3622-4549
e-mail: mxmoveis@mxmoveis.com.br

Ref. PGL02

Paneleiro
Cozinha/Cocina
GLORIA

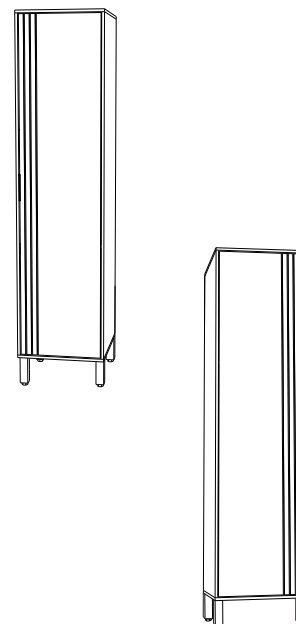
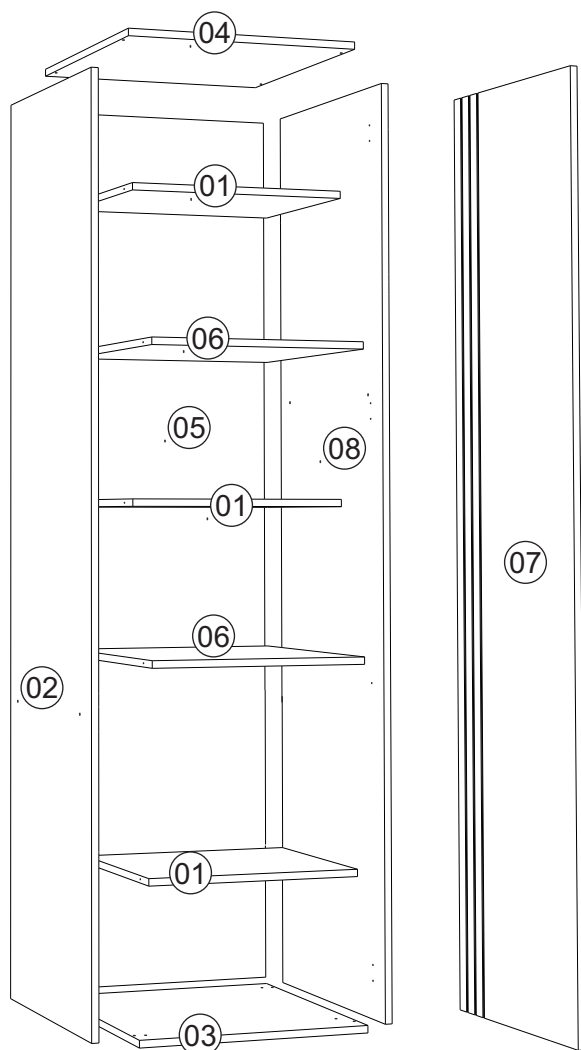

Obs:A porta pode ser montada tanto para a direita quanto para a esquerda.

Nota: La puerta se puede montar a la derecha o a la izquierda.

Note: The door can be mounted either to the right or to the left.

Nº	CÓDIGO ASSISTÊNCIA CODE ATTENDANCE	NOME DA PEÇA/DESCRIPCIÓN PIEZAS/DESCRIPTION PARTS	MEDIDAS (mm) MEASURES (mm)	QTD.	CASTANHO	BRANCO NEVE
01	PGL02.02.00	Base interna/Base/Inner base	460x387x15	03	273336	273336
02	PGL02.18.00	Lateral externa esquerda/Lateral izquierda/Left side	1905x516x15	01	274739	277629
03	PGL02.01.00	Base Inferior/Base/Shelf	516x490x15	01	275254	277626
04	PGL02.05.00	Base superior/Base superior/Top base	516x490x15	01	275255	277627
05	PGL02.13.00	Forro/Revés/botton	1917x472x2.5	01	273334	273334
06	PGL02.02.01	Base interna/Base/Inner base	496x460x15	02	273337	273337
07	PGL02.25.00	Porta/Puerta/Door	1897x452x15	01	274740	277630
08	PGL02.17.00	Lateral externa direita/Lateral derecha/Right side	1905x516x15	01	274738	277628

Ferragens/Herrajes/Hardware

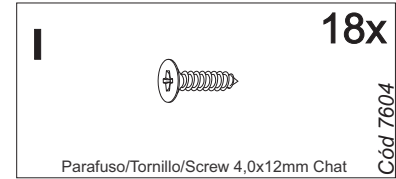
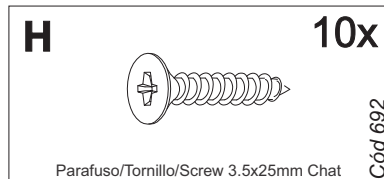
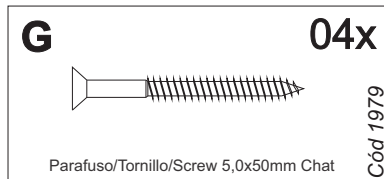
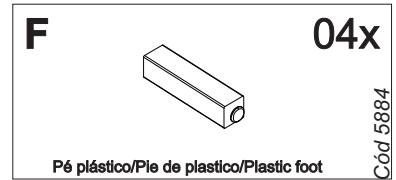
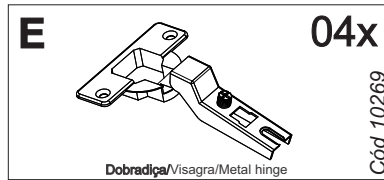
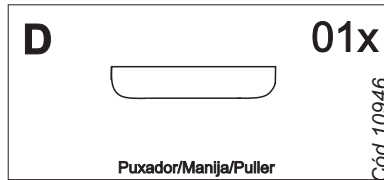
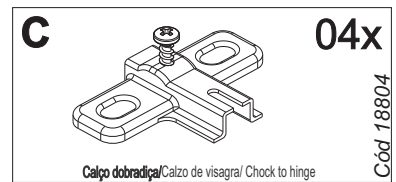
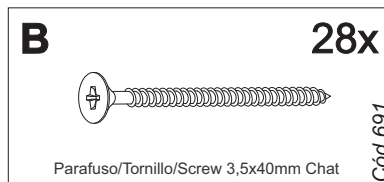
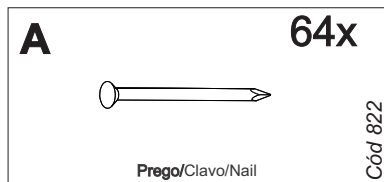

Obs: a régua serve para medição da ferragem.
Nota: la regla se utiliza para medir el hardware.
Note: the ruler is used to measure the hardware.

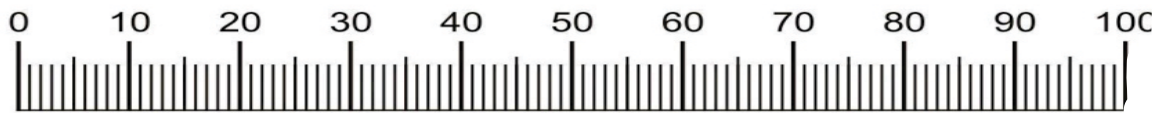

Medidas em mm
Measures in mm
Mesuras en mm

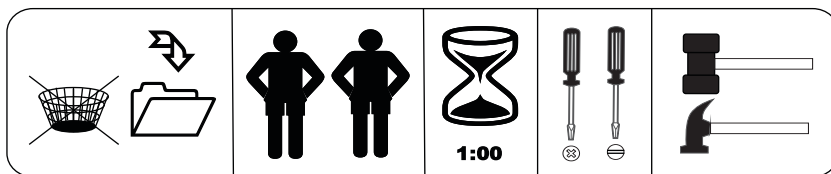

	Giz para madeira	Produto para ser aplicado em caso de riscos na superfície.
	Giz para madeira	Product to be applied in case of scratches on the surface.
	Giz para madeira	Producto para ser aplicado en caso de rayas en la superficie.

! *Usar os parafusos (H) para unir este módulo a outro.
Usar los tornillos (H) para unirse este módulo a otro. **!**
*Use the screws (H) to connect this module to another.

Pré-Montagem/Preparación Piezas/ Pre-assembly

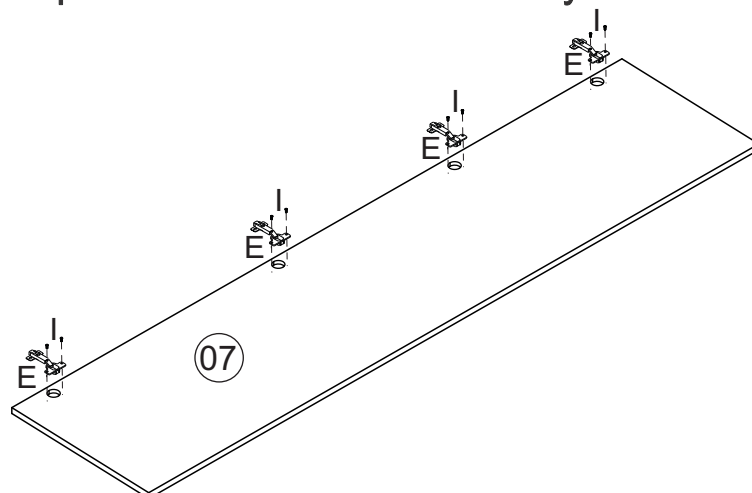
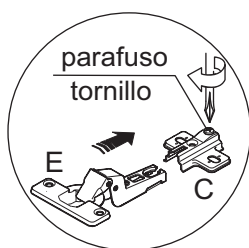

01 Montagem/Montaje/Assembly

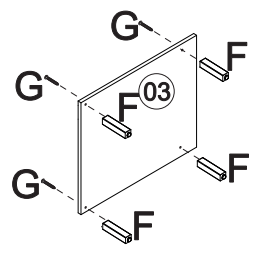
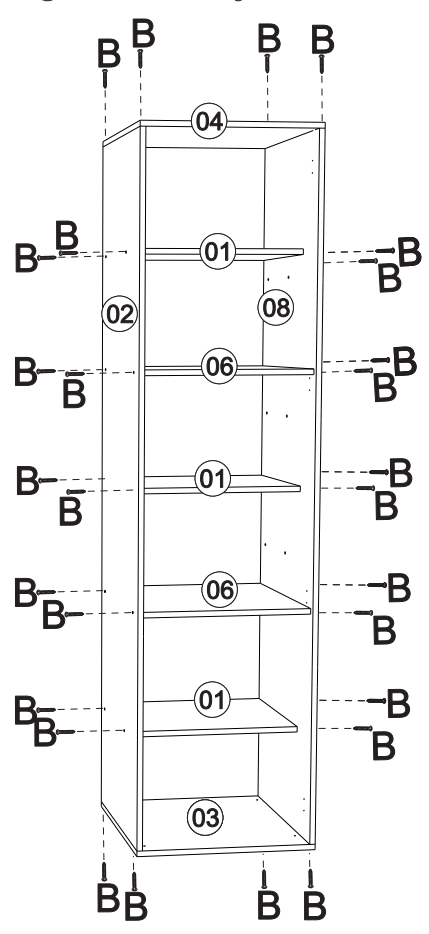

02 Montagem/Montaje/Assembly

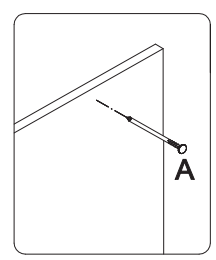
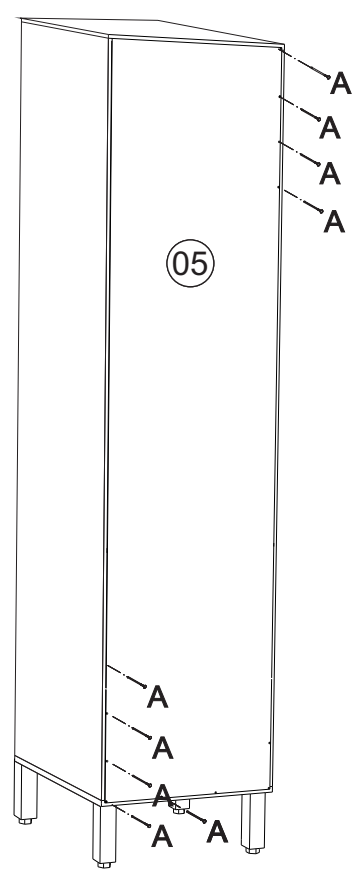

*Colocar um prego (A) a cada 100mm
 *Colocar un clavo cada (A) 100mm
 *Place a nail every (A) 100mm

03 Montagem/Montaje/Assembly

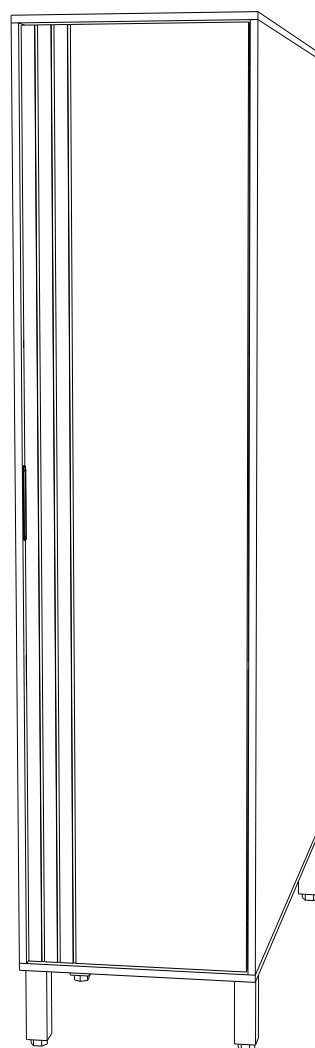
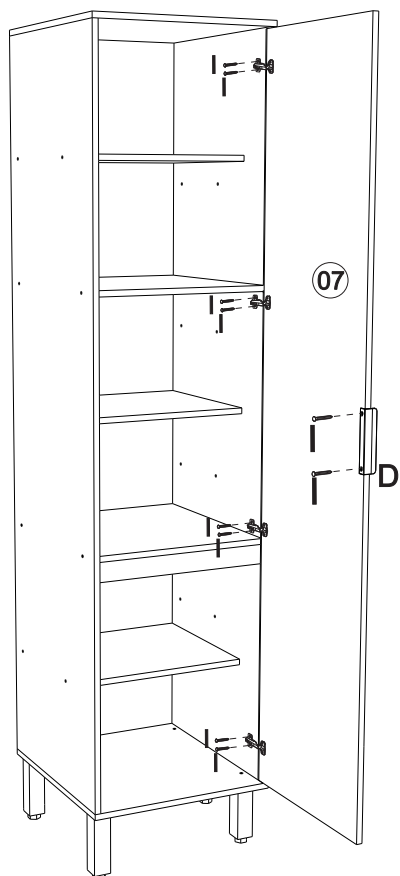

Limpeza/Limpieza

- ✎ Use um pano levemente umedecido com água, seguido de pano seco.
- ✎ Use solamente un paño húmedo con agua y después un paño seco.
- ✎ Nunca utilize produtos químicos ou abrasivos.
- ✎ No utilice productos químicos o abrasivos.