



mxmóveis

Rodovia SC-492 - Km 10 - B. Industrial
89905-000 - Bandeirante - SC
Fone: (49) 3622-4549
e-mail: mxmoveis@mxmoveis.com.br

Ref. PGL01

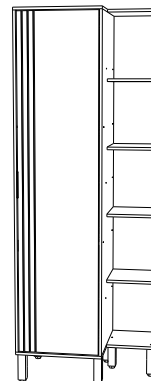
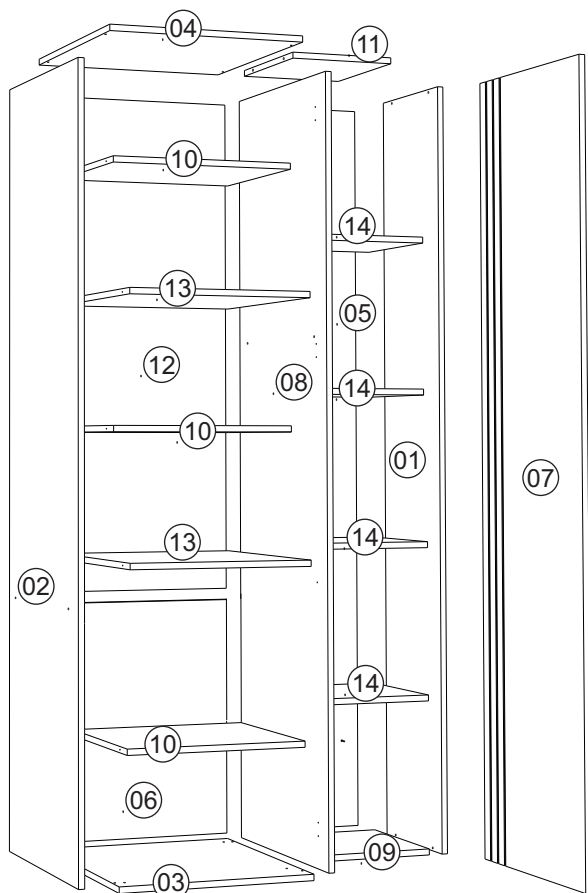

Paneleiro
Cozinha/Cocina
GLORIA

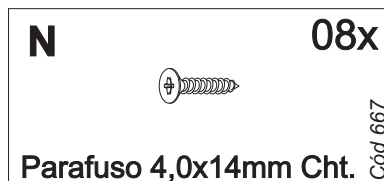
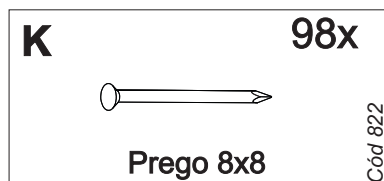
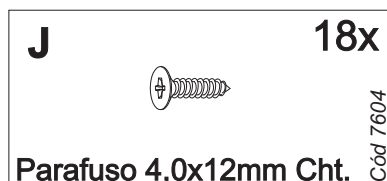
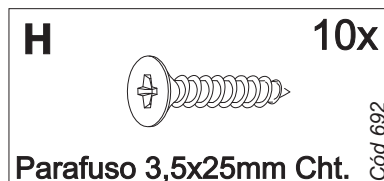
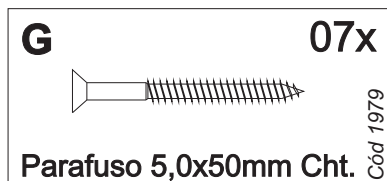
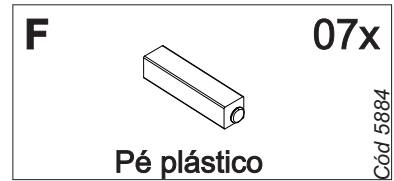
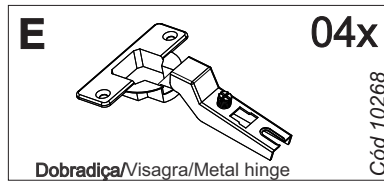
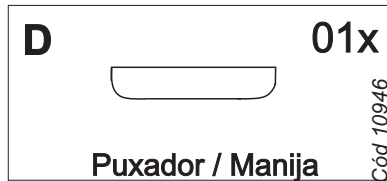
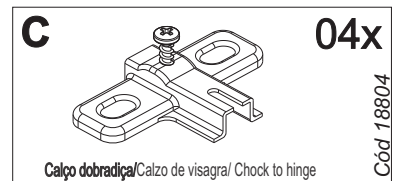
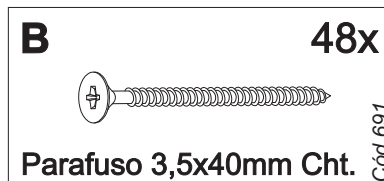
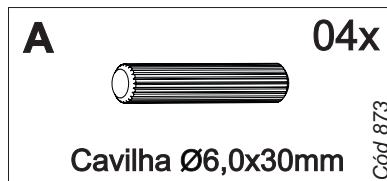

Nº	CÓDIGO ASSISTÊNCIA	NOME DA PEÇA/DESCRIPCIÓN PIEZAS	MEDIDAS (mm)	QTD.	CASTANHO CASTANHO
01	PGL01.17.00	Lateral externa direita/Lateral derecha	1905x516x15	01	263819
02	PGL01.18.00	Lateral externa esquerda/Lateral izquierda	1905x516x15	01	263821
03	PGL01.01.00	Base inferior/Base inferior	516x490x15	01	264636
04	PGL01.05.00	Base superior/Base superior	516x490x15	01	264638
05	PGL01.13.02	Forro/Revés	1919x288x2.5	01	263813
06	PGL01.13.00	Forro/Revés	476x642x2.5	01	261644
07	PGL01.25.00	Porta/Puerta	1897x452x15	01	263824
08	PGL01.17.02	Lateral externa nicho/Lateral izquierda	1935x300x15	01	263823
09	PGL01.01.01	Base inferior/Base inferior	300x270x15	01	264637
10	PGL01.02.02	Base interna	460x387x15	03	261660
11	PGL01.05.01	Base superior/Base superior	300x270x15	01	264638
12	PGL01.13.01	Forro/Revés	1277x476x2.5	01	261645
13	PGL01.02.00	Base interna	496x460x15	02	261649
14	PGL01.02.01	Base interna	300x270x15	04	263816

Ferragens/Herrajes



 *Usar os parafusos (H) para unir este módulo a outro.  Usar los tornillos (H) para unirse este módulo a otro.

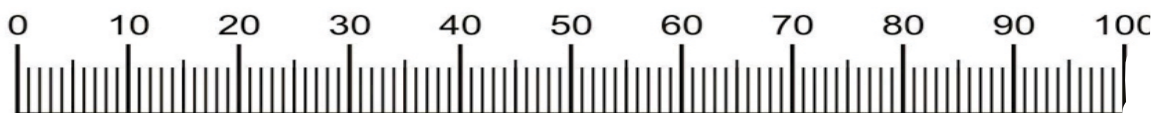

Medidas em mm
Measures in mm
Meduras en mm

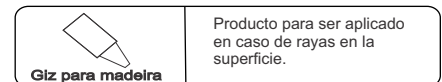
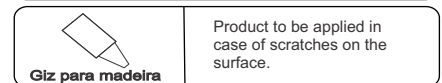
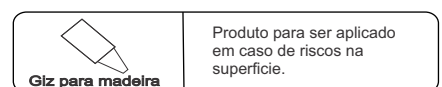
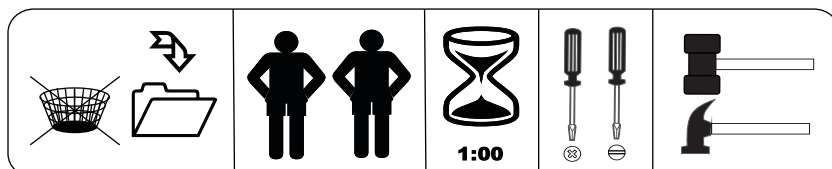

Pré-Montagem/Preparación Piezas

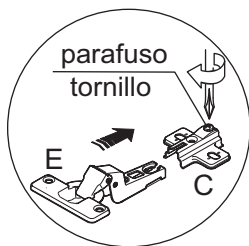
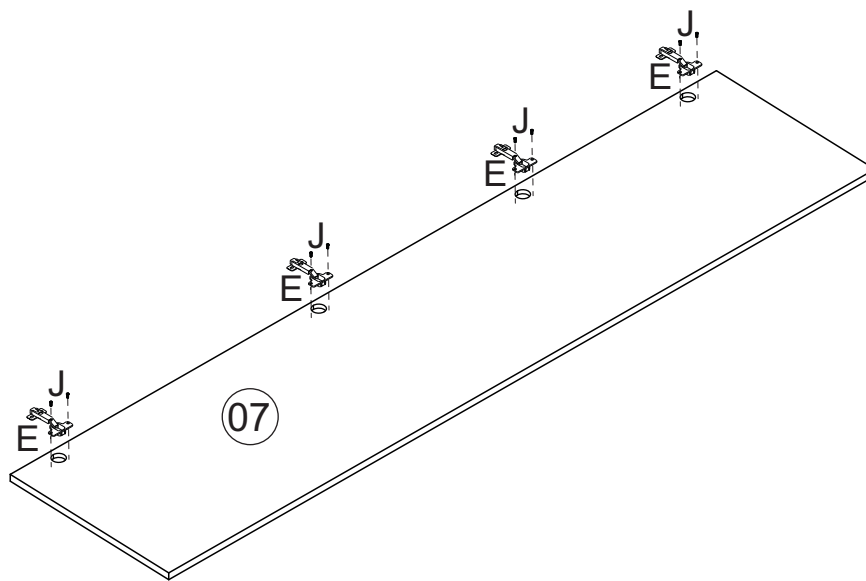

Utilizar
cola nas
cavilhas.

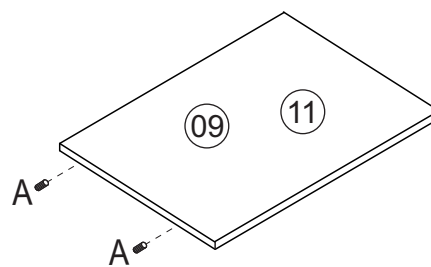

01 Montagem/Montaje

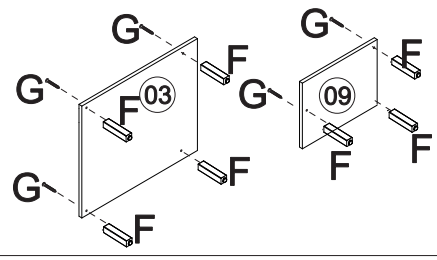
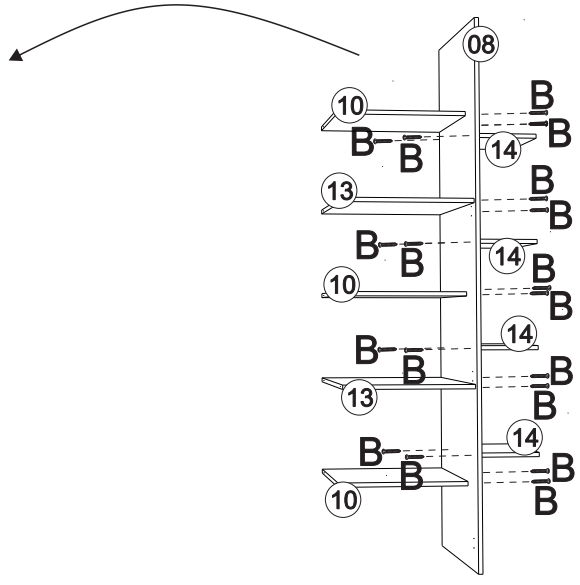
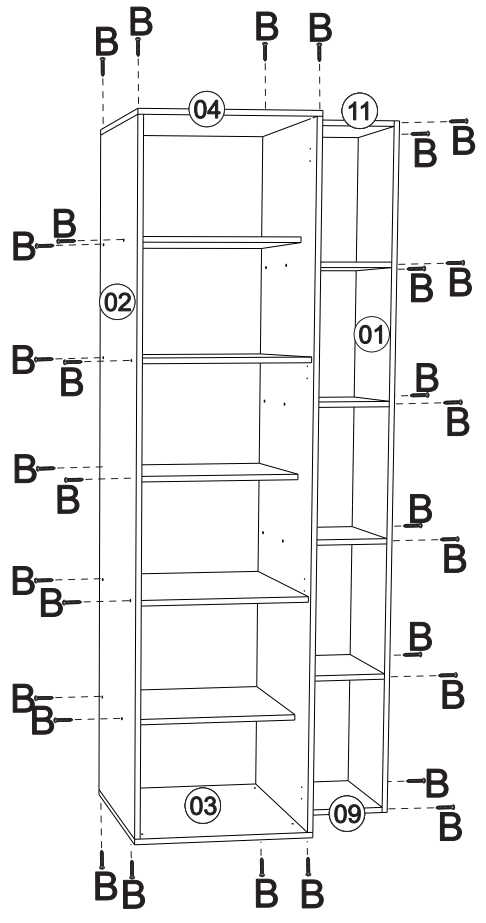

02 Montagem/Montaje

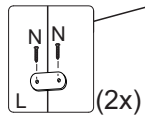

São utilizados 2 junção para melhor fixação entre o aéreo e a torre.

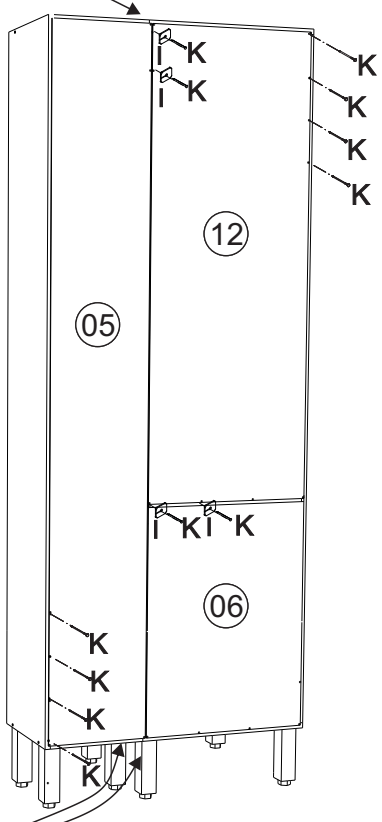

São utilizados 2 junção para melhor fixação entre o aéreo e a torre.

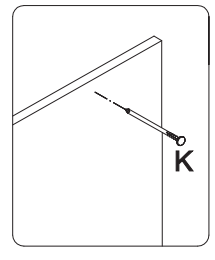
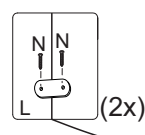

*Colocar um prego (K) a cada 100mm
 *Colocar un clavo cada (K) 100mm
 *Place a nail every (K) 100mm

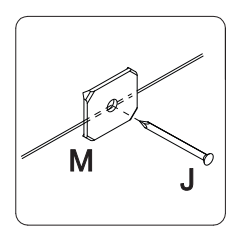

*Usar o prego (K) e a junção (L) a cada 100mm
 *Usar el clavo (K) y la junta (L) cada 100mm
 *Use the nail (K) and the joint (L) every 100mm

03

Montagem/Montaje

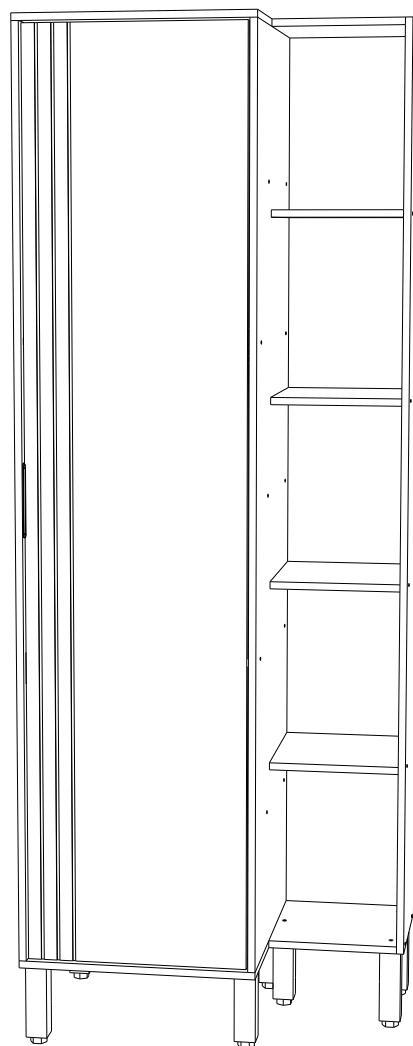
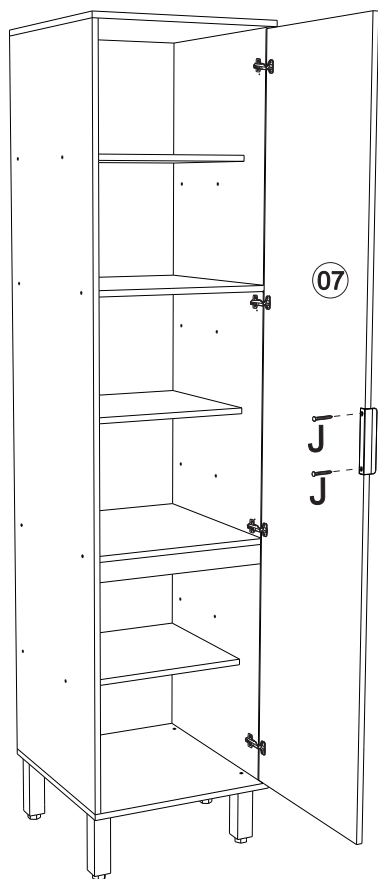

Limpeza/Limpieza

- ✍ Use um pano levemente umedecido com água, seguido de pano seco.
- ✍ *Use solamente un paño húmedo con agua y después un paño seco.*
- ✍ Nunca utilize produtos químicos ou abrasivos.
- ✍ *No utilice productos quimicos o abrasivos.*