

CO8104 - PANELEIRO 0,40 M

Manual de Montagem
Assembly Instructions
Instrucción de Montaje

decibal[®]
móveis

Produto Montado
Producto final
Assembled

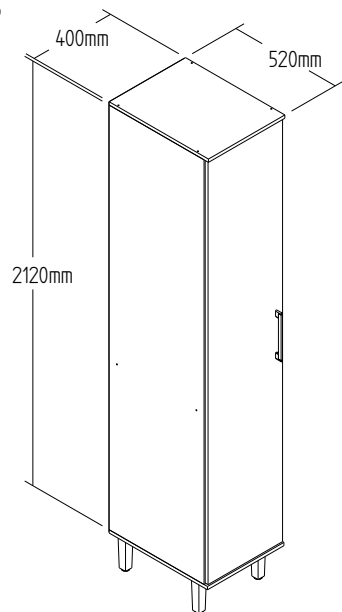

1º

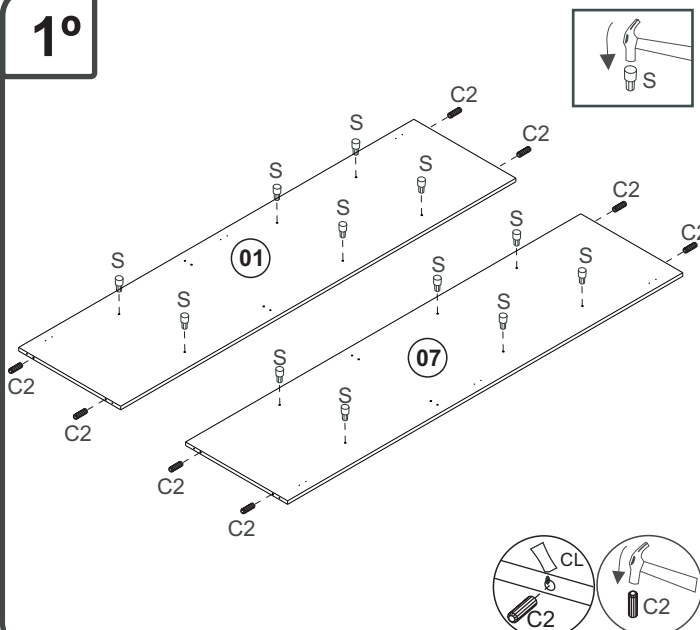

2º

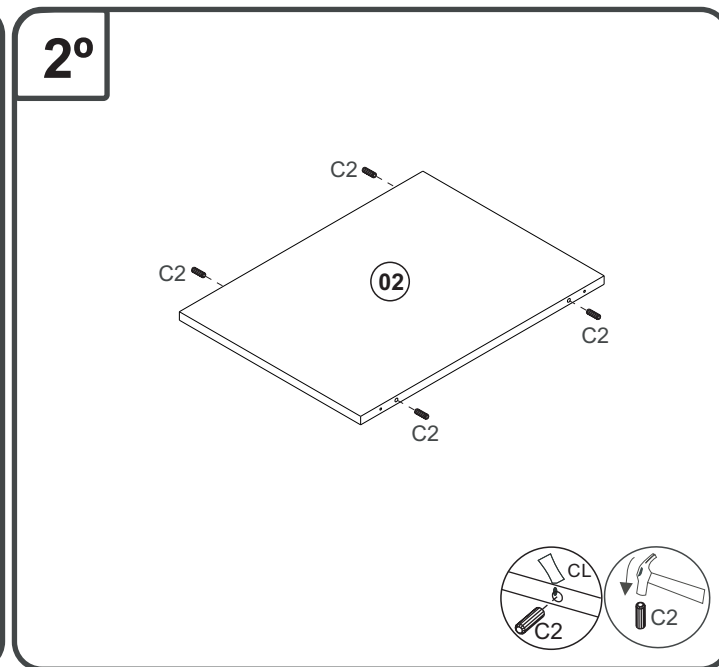

3º

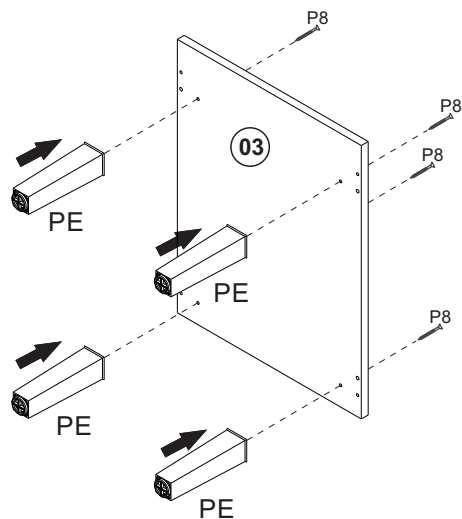

4º

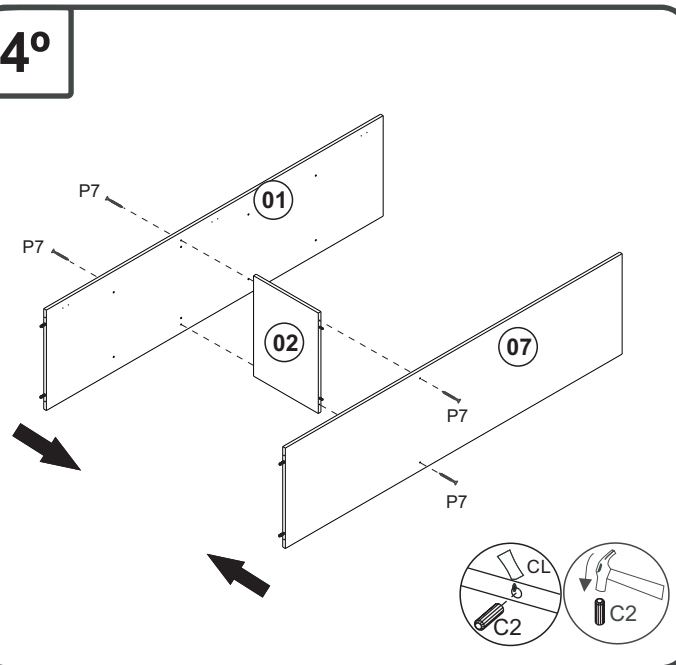

5º

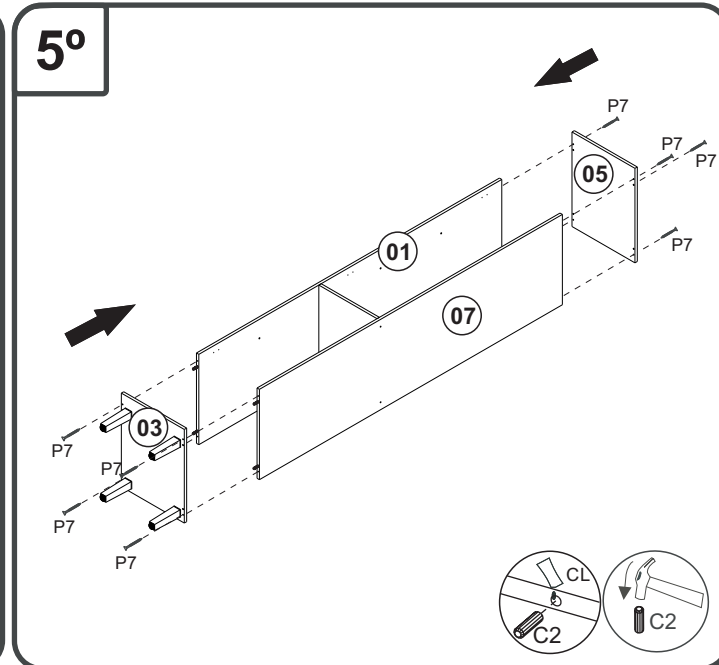

CO8104 - PANELEIRO 0,40 M

Manual de Montagem
Assembly Instructions
Instrucción de Montaje



6°

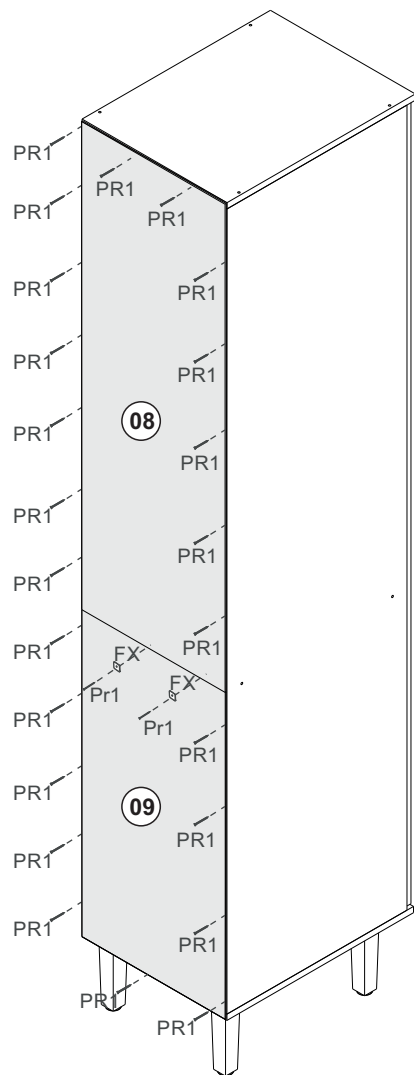
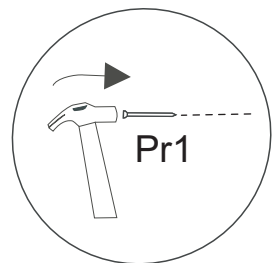

7°

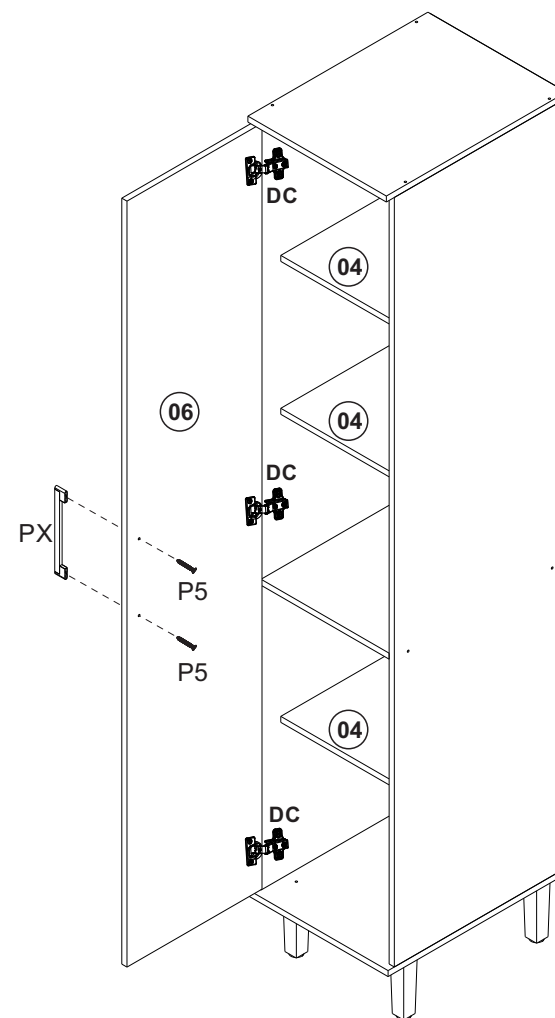
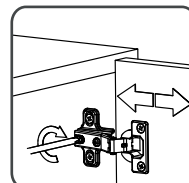
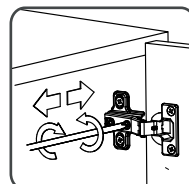
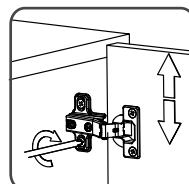
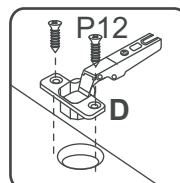
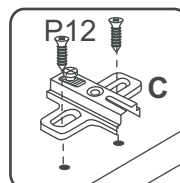

CO8104 - PANELEIRO 0,40 M

Manual de Montagem
Assembly Instructions
Instrucción de Montaje



8°

Fixação parede
Fixed in the wall

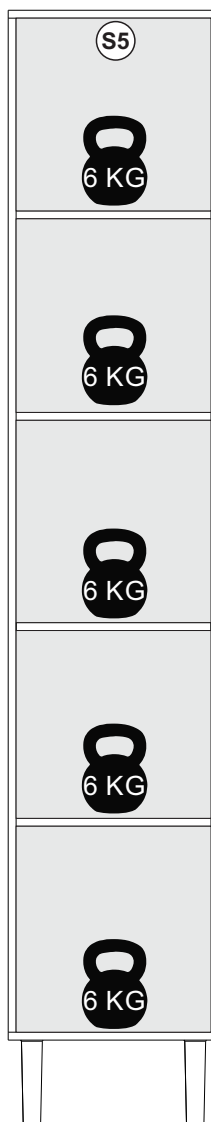
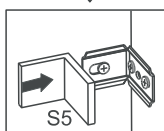
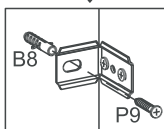
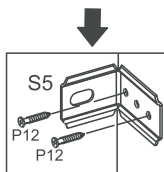

Relação de Peças/ Relación de Piezas/Parts List

N°	CÓDIGO/CODE	DESCRIÇÃO/DESCRIPCIÓN/DESCRIPTION	QTD/CANT	VOL.
1	0540814	LATERAL ESQ/LATERAL/SIDE 1925X497X15 MM	1,00	1
2	0540819	BASE 497X370X15MM	1,00	1
3	0540813	BASE 515X400X15MM	1,00	1
4	0540816	PRATELEIRA/ESTANTE/SHELF 440X370X15MM	3,00	1
5	0540815	BASE 520X400X15MM	1,00	1
6	0540818	PORTA/PUERTA/DOOR 1916X390X15MM	1,00	1
7	0540820	LATERAL DIR/LATERAL/SIDE 1925X497X15 MM	1,00	1
8	0540817	COSTA/REVÉS/BACK 1167X396X2,8 MM	1,00	1
9	0540821	COSTA/REVÉS/BACK 782X396X3,2 MM	1,00	1

www.decibal.com.br

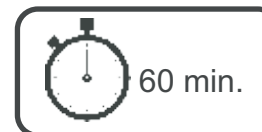

60 min.



1 montador
1 ajustador
1 Fitter

Ferramenta necessárias
Necessary tools
Herramientas necesarias



ATENÇÃO!!!! montadores e consumidores

* Ajustar o torque da parafusadeira para não danificar as peças escareando o parafuso *

ATENCIÓN!!!! montadores e consumidores

* Ajuste el torque del destornillador para no dañar las piezas avallanando el tornillo *

ATTENTION!!!! assemblers and consumers

* Adjust the torque of the screwdriver so as not to damage the parts by countersinking the screw *

ATENÇÃO!!!! montadores e consumidores

* Para limpar o móveis utilize somente um pano úmido (umedecido em água pura ou água com sabão neutro). Depois, passe um pano seco. Evite a umidade excessiva.

* Evite usar álcool, água sanitária, detergente e outros produtos químicos, mesmo diluídos em água. Não utilize produtos abrasivos de nenhuma espécie

ATENCIÓN!!!! montadores e consumidores

* Para limpiar el mueble utilice solamente un paño húmedo (humedecido con agua limpia o con un jabón suave).

Acontinución, utilice un paño seco. Evite el exceso de humedad.

* Evite uso de alcohol, hipoclorídrico solución basada, detergente y otros productos químicos, mismo diluídos en água.

No utilice productos abrasivos de ningún tipo.

ATTENTION!!!! assemblers and consumers









*To clean the furniture, use only a damp cloth (humidify it only in pure water ou water and neutral soap).After, use a dry cloth.Avoid excessive humidity.

*Avoid using alcohol, bleach, detergent and other chemical products, even diluted in water. Do not use any kind of abrasive cleaning agents to clean the furniture.









The use of such products may jeopardize the ?nal characteristics of the furniture.

Ferragens/ Herrajes/ Hardware

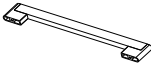
Escala (1:1)

LEGENDA	DESCRIÇÃO/DESCRIPCIÓN/DESCRIPTION	CÓDIGO	QUANT.
P7	 PARAFUSO/TORNILLO/SCREW 4X45	01318	12
PR1	 PREGO/CLAVO/NAIL 10X10	01330	50
C2	 CAVILHA/TARUGO/DOWEL 6X30 MM	01211	13
P8	 PARAFUSO/TORNILLO/SCREW 5X45	01320	04
PU	 PARAFUSO UNIÃO/UNIÓN DETORNILLO /SCREW UNION	01495	02
P12	 PARAFUSO/TORNILLO/SCREW 3X13 CABEÇA FLANGEADA	09927	14
B8	 BUCHA / BUJE / BUCHING 8 MM	01311	01
P9	 PARAFUSO/TORNILLO/SCREW 6X50	03827	01
P5	 PARAFUSO/TORNILLO/SCREW 3,5X25	09955	02

Escala (N/A)

LEGENDA	DESCRIÇÃO/DESCRIPCIÓN/DESCRIPTION	CÓDIGO	QUANT.
CL	 COLA/PEGAMENTO/GLUE	01213	01
ET	 ETIQUETA LOGO DECIBAL/LABEL DECIBAL	01312	01
DC	 DOBRADIÇA/BISAGRA/HINGE D=35mm C=neg	03493	03
PX	 PUXADOR / PEGADOR / HANDLE	11020	01
S	 SUPORTE /SOPORTE /SUPPORT	01368	12
FX	 FIXADOR COSTA/FIJADOR FONDO/FIXER COAST	01331	04
AD	 ADESIVO/ADHESIVO/ADHESIVE	WOOD 09929 NATURALLE 09963	04
PE	 PÉ/PATA/FOOT	11121	04
S5	 CAPA SUPORTE AÉREO /PORTADA APOYO AÉREO/AIR SUPPORT COVER	03828 09647(WOOD)	01

Medida em mm

