

# Rack Painel MALAGA BC-5316

Lote: 000000

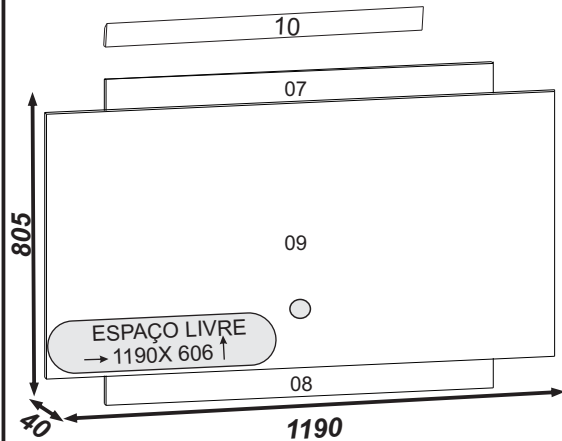

- 01-Tampo Superior
- 02-Tampo Inferior
- 03-Lateral Esquerda
- 04-Lateral Direita
- 05-Divisoria
- 06-Porta
- 07-Travessa Superior
- 08-Travessa Inferior
- 09-Painel
- 10-Travessa Parede
- 11-Travessa Passa Fio (2x)
- 12-Costa (2x)

- 01-Tapa Superior
- 02-Tapa Inferior
- 03-Lateral Izquierda
- 04-Lateral Derecha
- 05-Division
- 06-Puerta
- 07-Travessaño Superior
- 08-Travessaño Inferior
- 09-Panel
- 10-Travessaño Del Pared
- 11-Travessaño Pasa Cable (2x)
- 12-Dorso (2x)

- 01-Upper Top
- 02-Lower Top
- 03-Left Side
- 04-Right Side
- 05-Divider
- 06-Door
- 07-Upper Crossbar
- 08-Lower Crossbar
- 09-Panel
- 10-Crossbar Wall
- 11-Pass Wire Crossbar (2x)
- 12-Back Panel (2x)

DIMENSÕES PEÇAS PRONTAS  
DIMENSIONES DE LAS PEZAS PRONTAS  
DIMENSIONS READY MADE PARTS

- 01-1190 X 337 X 15
- 02-1190 X 337 X 15
- 03-386 X 335 X 15
- 04-386 X 335 X 15
- 05-386 X 299 X 15
- 06-606 X 379 X 15
- 07-908 X 156 X 15
- 08-908 X 131 X 15
- 09-1190 X 606 X 12
- 10-910 X 65 X 25
- 11-130 X 95 X 25
- 12-591 X 412 X 3

## Ferragens/Herraje/Hardware:

330	A	Cavilhas 6 x 30 Clavija Wood Peg		12
0115	B	Parafuso minifix Tornillo Screw		05
0350	C	Tambor minifix 15 mm Minifix 15 mm Minifix 15 mm		05
3033	D	Cavilhas 6 x 25 Clavija Wood Peg		06
0477	E	Cola Pegamento Glue		01
5278	F	Parafuso 3,5 X 35 CC Tornillo Screw		02
0296	G	taxa 10 x 10 Clavo 10 x 10 Nail 10 x 10		50
7051	H	Parafuso 3,5 x 20 CC Tornillo Screw		16
-----	I	Canaleta plástica 1155mm Canaleta plastica 1155mm plastic channel 1155 mm		02
0941	J	Pino guia Pasador de guia Guide Pin		04
0289	K	Parafuso 3,5 X 40 CC Tornillo Screw		06
0285	L	Parafuso 3,5 x 25 CF Tornillo Screw		08
0279	M	Fixador De Costa Fixador de Espalda Fix Back		05
1246	N	Parafuso 5 X 80 C Soberba Tornillo Screw		04
0512	O	Bucha plástica pl/ concreto 8mm Buje plastica para hormigón 8mm Plastic bushing 8mm		04
-----	P	Tapa Furo Adesivo 18mm COR 1 Pegatina Para Agujeros 18mm COLOR 1 Slap hole adesivo 18mm color 1		05
-----	Q	Pé Pie Foot		04
-----	R	Passa Fio Pase cable Pass Wire		01

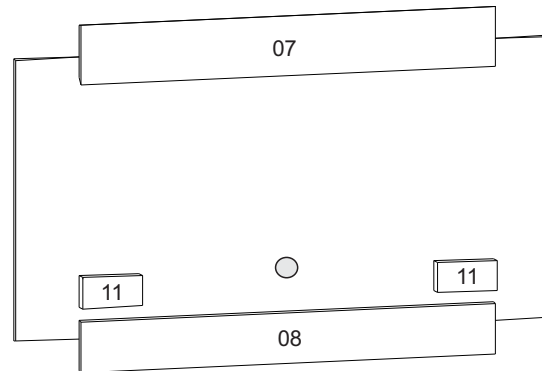
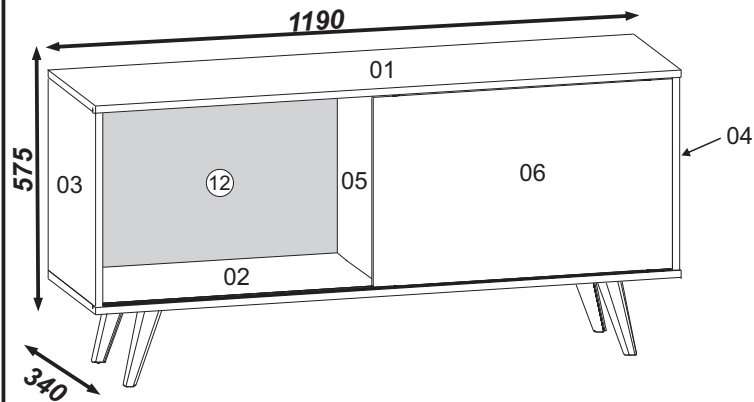

### Instruções para a montagem do produto: Product assembly instructions: Instrucciones de montaje del Producto:

- Separe as peças e acessórios de maneira organizada.**  
Separate the parts and accessories in an organized way.  
Separe las piezas y accesorios de forma organizada

- Forrar o chão com o papelão das embalagens.**  
Cover the floor with the cardboard from the pack.  
Cubre el suelo con el cartón de los bultos.



- É necessário duas pessoas para montar o produto.**  
It's necessary two people to assembly the product.  
Se requiere dos personas para montar el producto.

### Ferramentas necessárias (não fornecidas)

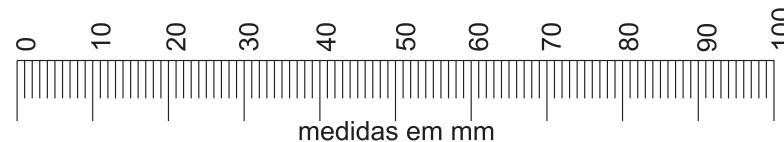
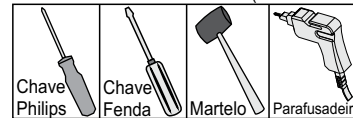

MANUAL DE MONTAGEM  
INSTRUCCIONES DE ARMADO  
ASSEMBLY INSTRUCTIONS

**01° Passo**

**01° Paso**

**01° Step**

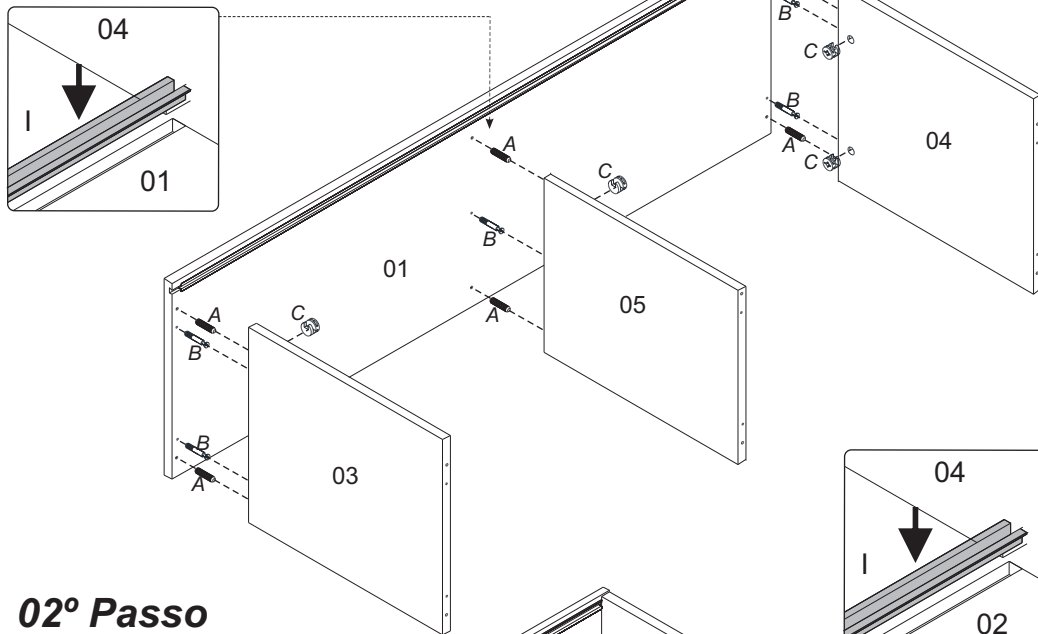

**02° Passo**

**02° Paso**

**02° Step**

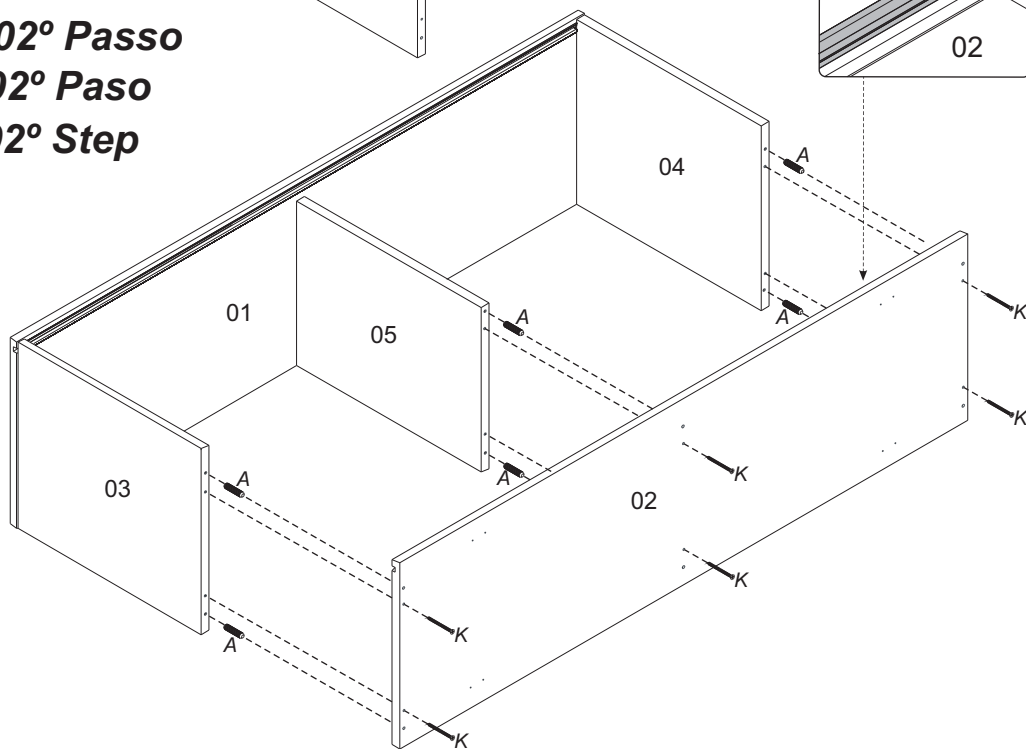

**03° Passo**

**03° Paso**

**03° Step**

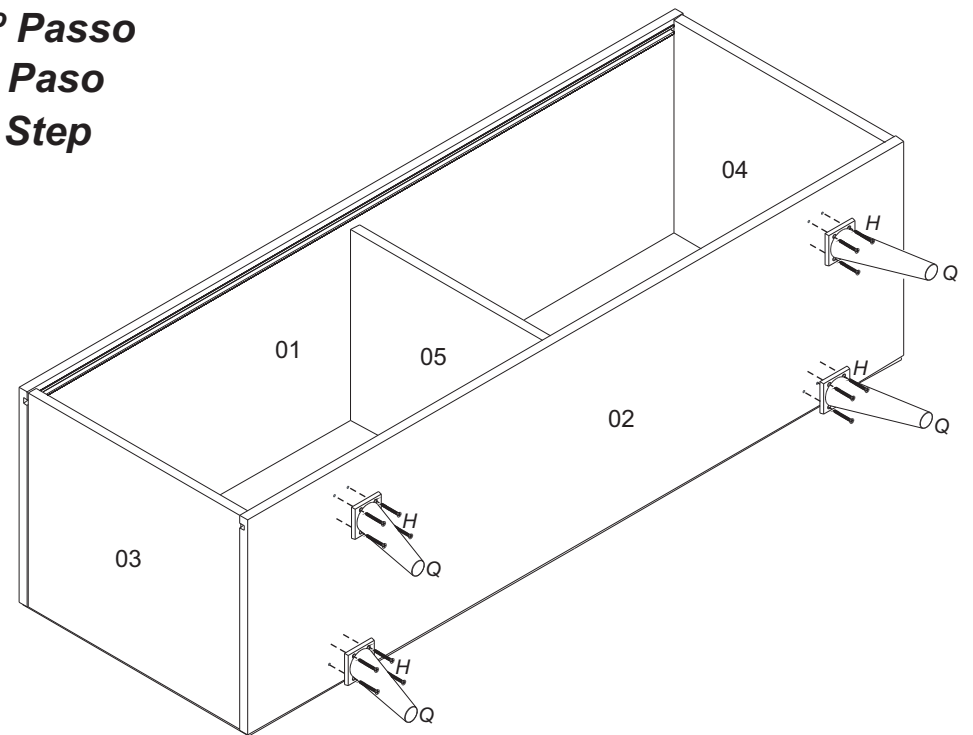

**04° Passo**

**04° Paso**

**04° Step**

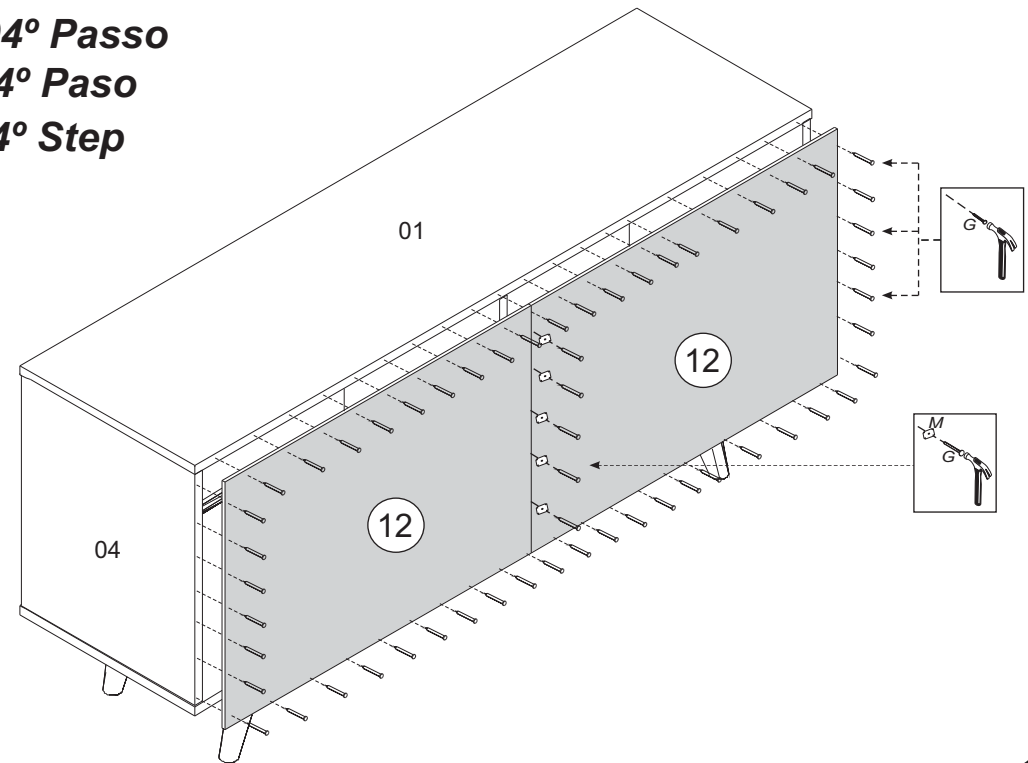

**05° Passo**  
**05° Paso**  
**05° Step**

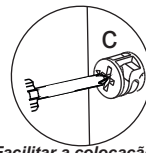
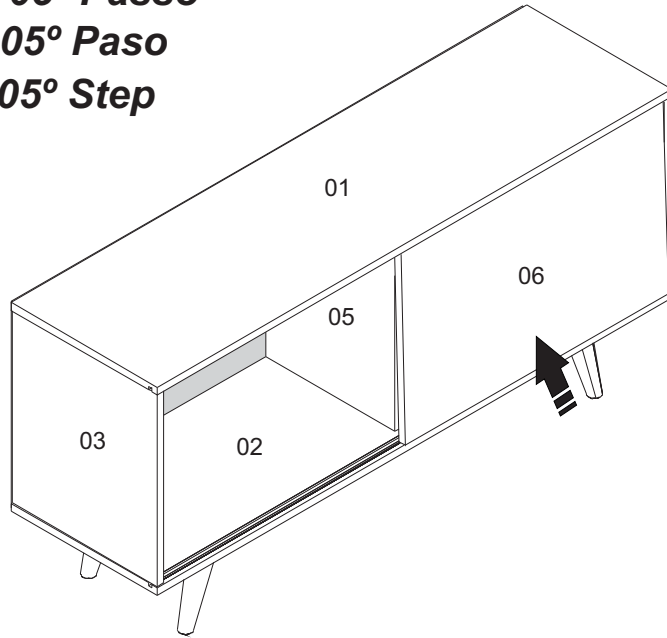

Para Facilitar a colocação da porta soltar o Tambor Girofix (C) da peça 04, após a colocação da porta aberta novamente.

Para facilitar la colocación de la puerta. liberar el tambor Girofix (C) de la parte 04. Después de colocar la puerta, vuelva a apretar.

To Facilitate the placing the door loosen the Girofix (C) drum of parte 04, after placing the door squeeze again.

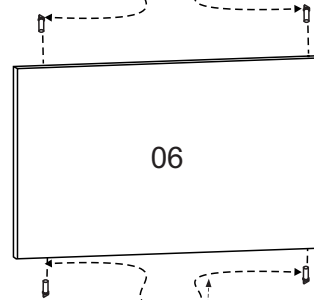

**06° Passo**  
**06° Paso**  
**06° Step**

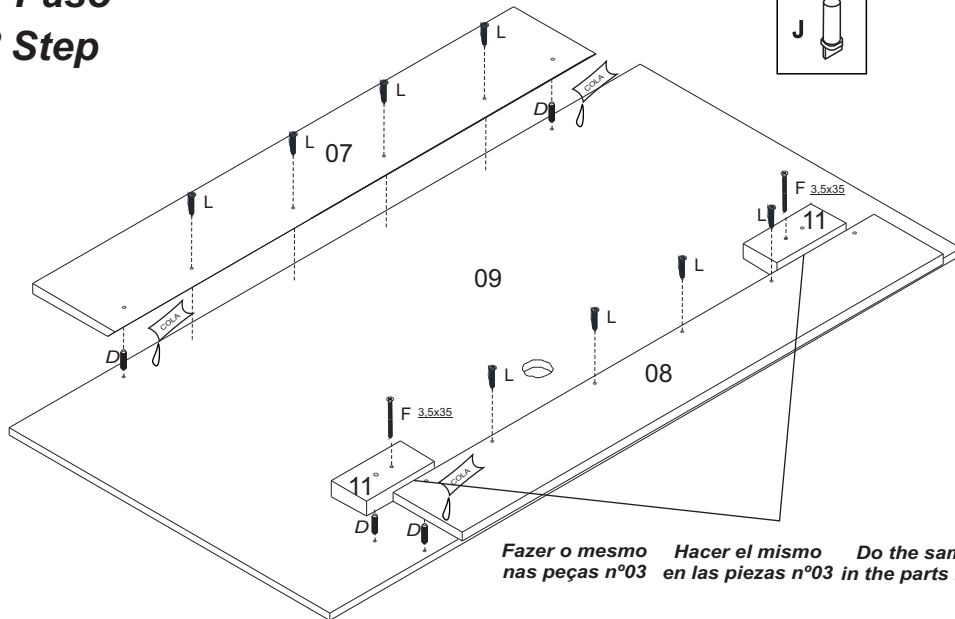

Fazer o mesmo nas peças nº03 Hacer el mismo en las piezas nº03 Do the same in the parts nº03

**07° Passo**  
**07° Paso**  
**07° Step**

**Obs:**

- \* Com esta regulagem, o painel 08 permanece a uma distância de 725 mm do piso.
- \* Caso deseje uma altura diferenciada, deverá ajustar a travessa 10 de acordo com a medida desejada.
- \* Con esta regulaje, el panel 08 permanece a una distancia de 725 mm del piso
- \* Caso quieras una altura diferenciada, debe ajustar la travesa 10 de acuerdo con la medida desejada.
- \* With this adjust, the panel nº08 remain with a distance of 725 mm from the floor
- \* floorlf you desire a different height, you should adjust the cross nº10 as you would like

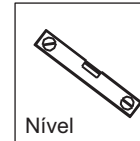

Nível

**Dica:**

Se possível utilize um nível para certificar que o painel ficará perfeitamente alinhado. **NÃO INCLUSO NA FERRAGEM**  
 Si posible utilice un nivel para certificar que el panel se quedará perfectamente alineado. **NO INCLUSO EN LA HERRAJE.**

If possible, use some level to certificate that the panel will be perfectly aligned. It isn't included

