

**TV até 55"**

DIMENSÕES DO PRODUTO / PRODUCT DIMENSIONS / DIMENSIONS PRODUCT - **WxDxH / LxPxA - 1600 X 300X 210 MM**

**PEÇAS NUMERADAS / NUMBERED PARTS / PIEZAS NUMERADAS**  
**EX: 1915X-X 04 (peça/ piece/ pieza number)**

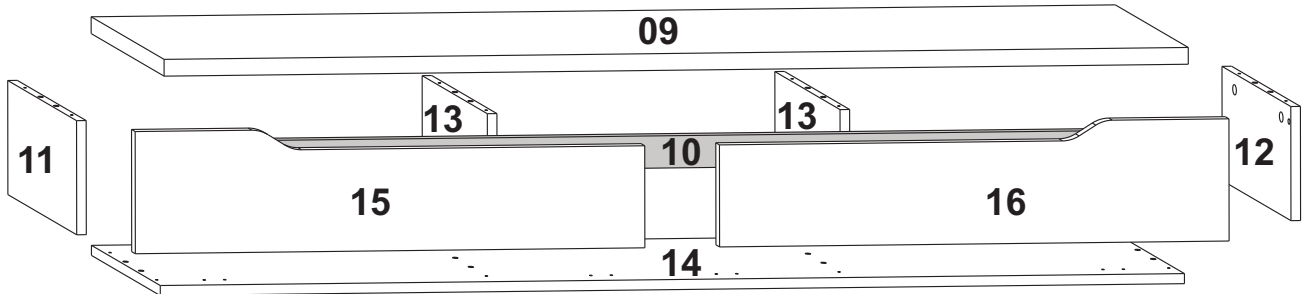
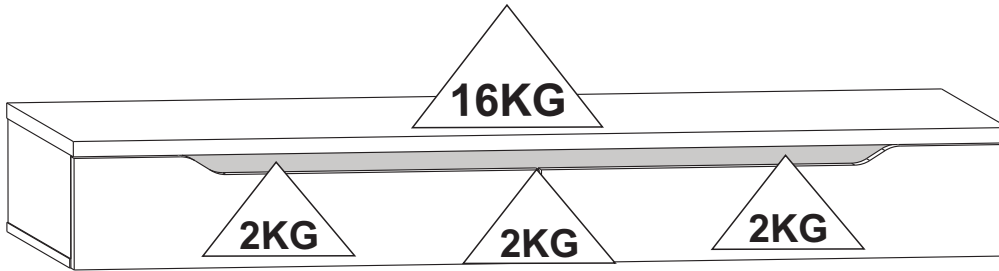

**ATENÇÃO / ATTENTION / ATENCION**

Nunca utilizar óleos, lustra móveis, produtos abrasivos, saponáceos, esponja de aço e outros.

Never use oils, furniture polish, abrasive products, soaps, steel sponge and others.

Nunca use aceites, pulimentos, abrasivos, jabones, esponja de acero y otros.

**CUIDADOS ESPECIAIS/ SPECIAL CARE/ CUIDADOS ESPECIALES**

- Evitar expor o móvel ao sol, e em lugares úmidos.
- Limpar com flanela seca ou com pano levemente umedecido em água.
- Avoid exposing the furniture to the sun, and in damp places.
- Clean with dry flannel or lightly cloth moistened with water.
- Evite exponer los muebles al sol y en lugares húmedos.
- Limpiar con franela seca o un paño ligero, humedecido con agua.

Ferramentas necessárias (não fornecidas) Necessary tools (not provided) Herramientas Necesarias (No proporcionadas)

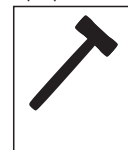

**MONTAR O PRODUTO SOBRE A EMBALAGEM, EVITANDO DANOS NA PINTURA. ACONSELHAMOS QUE A MONTAGEM DO PRODUTO SEJA POR UM PROFISSIONAL.**

**SETUP THE PRODUCT ON TOP OF THE PACKAGING, AVOIDING DAMAGE TO THE PAINT. WE RECOMMEND THAT THE INSTALLATION IS DONE BY A PROFESSIONAL.**

**MONTAR EL PRODUCTO EN EL PAQUETE, EVITAR LESIONES EN PINTURA. AVISAMOS QUE EL MONTAJE DEL PRODUCTO SEA UN PROFESIONAL.**



**MEDIDA UTILIZADA EM MM/ UNIT MEASURE USED IS MILLIMETERS (MM)**

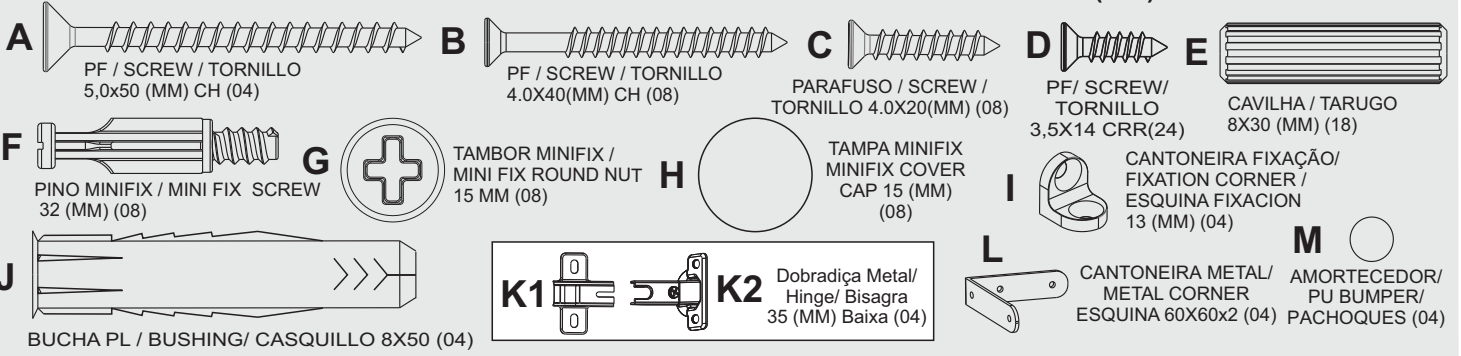

ITEM		DESCRIÇÃO DA PEÇAS / DESCRIPTION OF PARTS / UNIT MEASURE USED IS MILLIMETERS (MM)	CORES PRUDUTO / COLORS PRODUCT / COLORES PRODUCTO				
COD. CODE	Nº	NOME/NAME/NOMBRE	MEDIDAS / MEASURES (MM)	QUANT AMOUNT CANTIDAD	TIPO TYPE	OFF WHITE (CÓD. 06) CEDRO (CÓD. 03)	PRETO (CÓD. 07) CEDRO (CÓD. 03)
18614	9	TAMPO/ TOP	1600X300X25	1	MDP	09/06	09/07
18616	10	LATERAL ESQ/ LEFT SIDE/ LADO IZQUIERDO	283X170X15	1	MDP	10/06	10/07
18615	11	VISTA FRONT/ FRONT VIEW	1566X48X15	1	MDP	11/03	11/03
18618	12	DIVISOR ESQ DIR/ DIVIDER/	268X170X15	2	MDP	12/06	12/07
18617	13	LATERAL DIR/ RIGHT SIDE/ LADO DERECHO	283X170X15	1	MDP	13/06	13/07
18619	14	BASE	1600X283X15	1	MDP	14/06	14/07
18620	15	PORTA BASCULANTE ESQ/ DOOR/ PUERTA	796X182X15	1	MDF	15/06	15/07
18621	16	PORTA BASCULANTE DIR	796X182X15	1	MDF	16/06	16/07
15704	A	PF./ Screw/ Tornillo 5,0x50 CH		04			
438	B	PF. / Screw / Tornillo 4,0x40(MM) CH		08			
433	C	PF./Screw/ Tornillo 4,0x20(MM) CH		08			
986	D	PF./ Screw/ Tornillo 3,5x14(MM) CRR		24			
137	E	Cavilha / Wooden Dowel / Tarugo 8x30(MM)		18			
532	F	Pino Minifix /Minifix Screw 32(MM)		08			
508	G	Tambor Minifix / Minifix Round Nut 15(MM)		08			
509	H	Tampa Minifix / Minifix Cover Cap 15(MM)		08		BRANCA	PRETA
7125							
11136	I	Cantoneira Fixação ZAMAC/ Fixation Corner/ Esquina Fixacion 13x13 (MM)		04			
2922	J	Bucha Pl/ Bushing/ Casquillo 8X50 Cinza		04			
18030	K1/K2	Dobradiça Metal/Hinge/ Bisagra AL6 35 (MM) Baixa		04			
17498	L	Cantoneira Metal/ Metallic Corner/ Esquina Metálica 60x60x2 (MM)		04			
3441	M	Amortecedor/ Pu Bumper/ Parachoques		04			
<b>PREPARAÇÃO DE PEÇAS / PARTS PREPARATION / PREPARACION DE PIEZAS</b>				01			

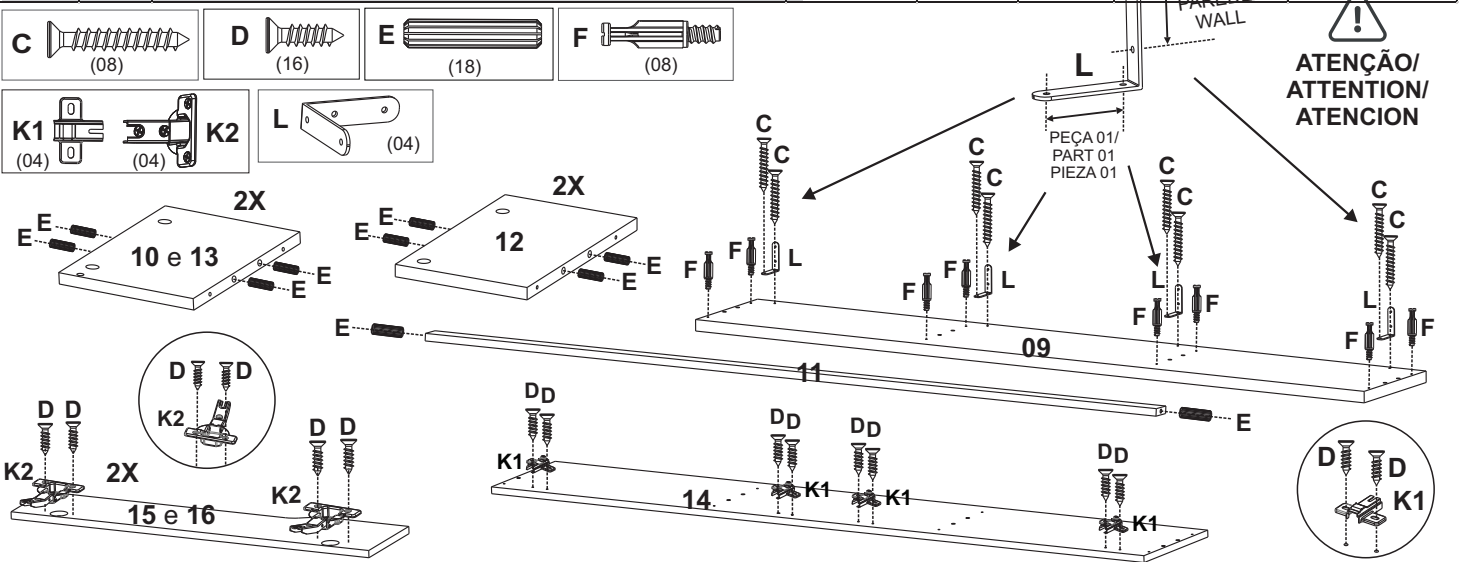

Obs: As peças pintadas nos passos são apenas ilustrativas. The parts painted in the steps are illustrative only. Las partes pintadas en los pasos son solo ilustrativas.

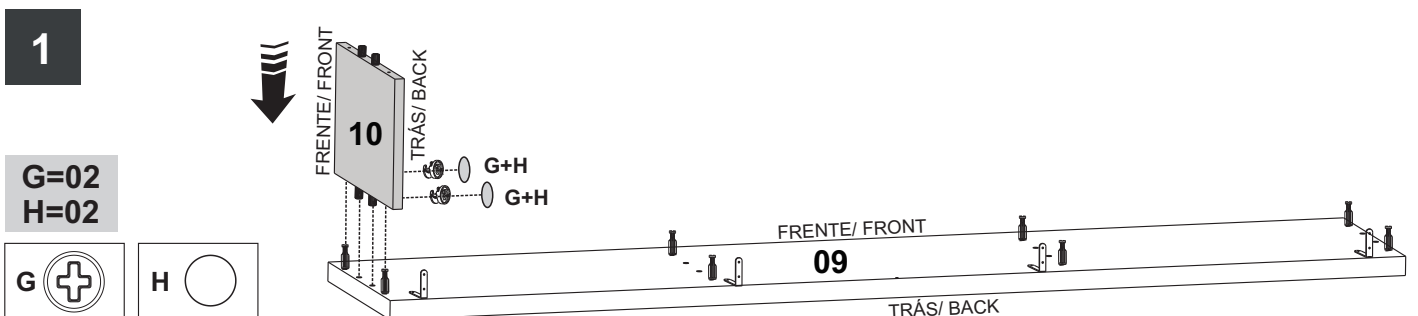

2

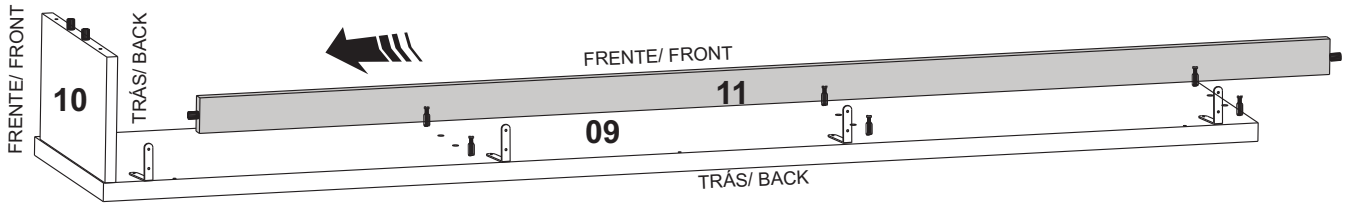

3

G=06  
H=06

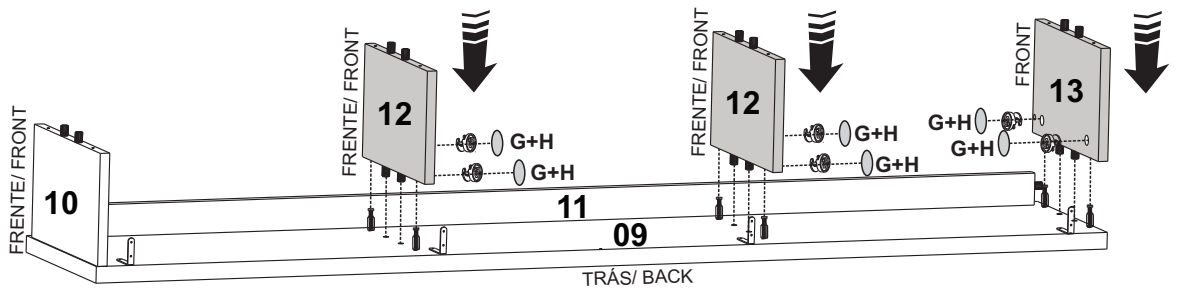

4

D=08  
I=04

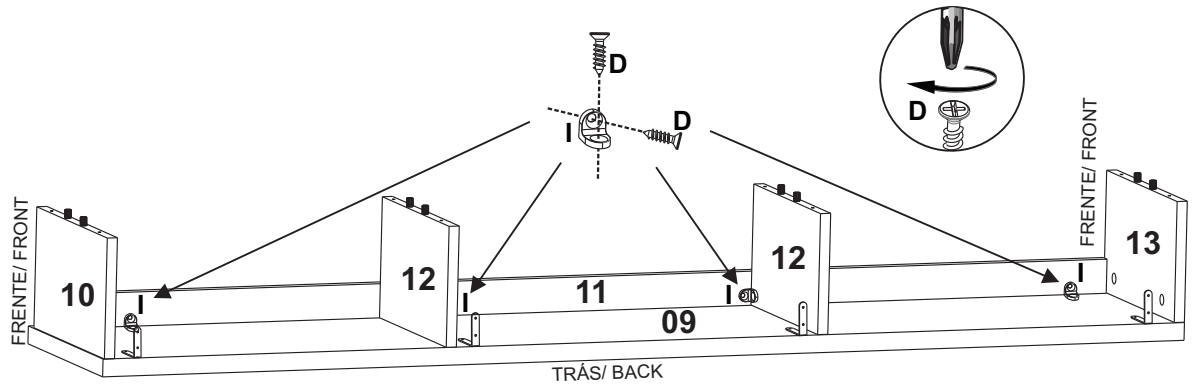
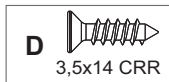

5

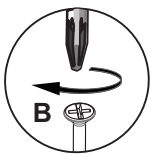

B=08

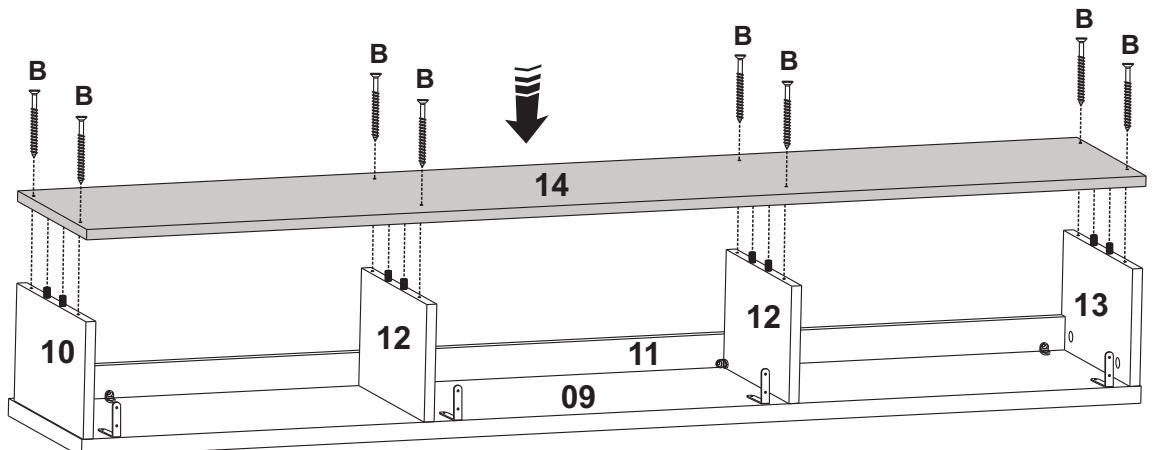
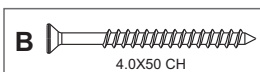



**ATENÇÃO/ ATTENTION/ ATENCION**

A ALTURA PARA FIXAR O NICHO É OPCIONAL.  
THE HEIGHT TO FIX THE TV NICHE IS OPTIONAL.  
LA ALTURA PARA FIJAR EL NICHO DEL TV ES OPCIONAL

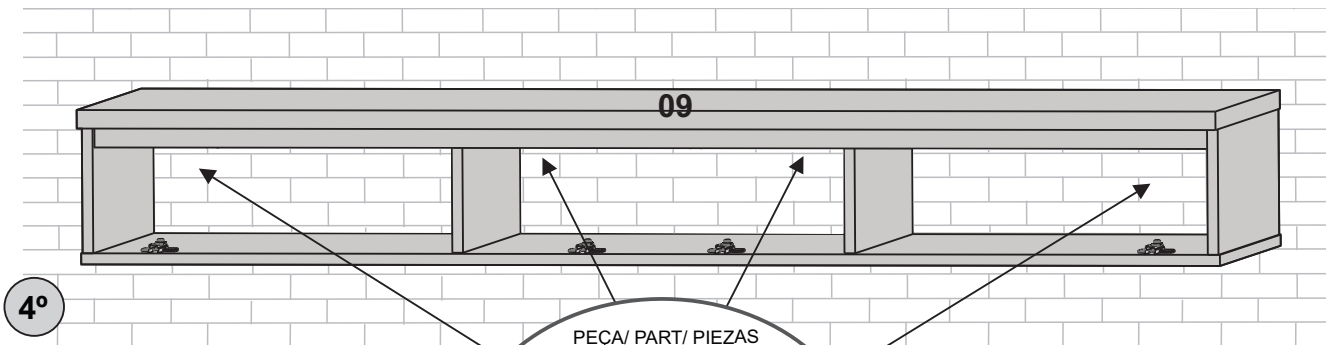
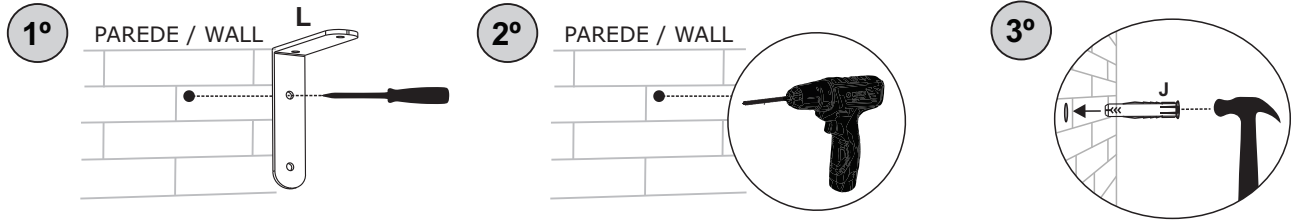

4°

PEÇA/ PART/ PIEZAS

09

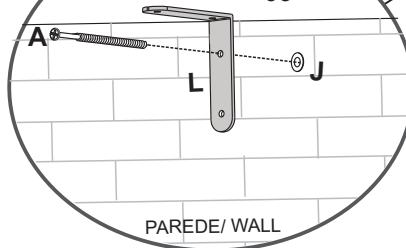

PAREDE/ WALL

A=04  
J=04

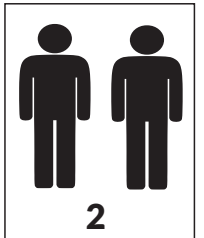
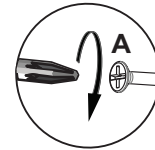
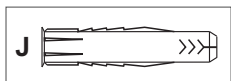
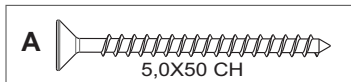

2

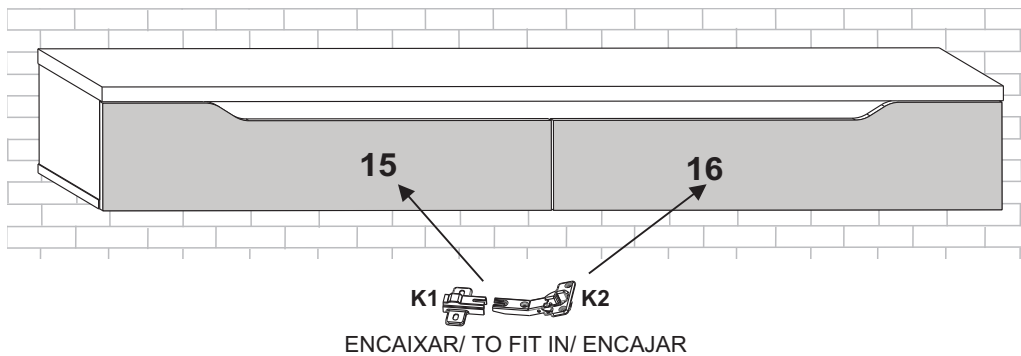

ENCAIXAR/ TO FIT IN/ ENCAJAR

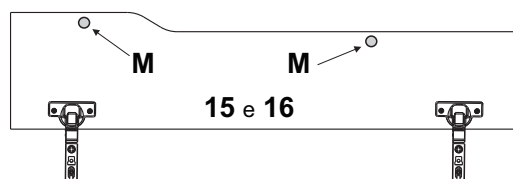

REGULAR/ ADJUST/ AJUSTE

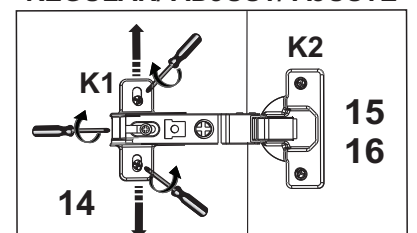

M=04

M

**NOTA / NOTE** Não nos responsabilizamos por acidentes, se a instalação do móvel não estiver com os procedimentos deste Manual e não for realizado por pessoa habilitada.  
We are not responsible for accidents if the installation of the furniture is not in accordance with the procedures in this Manual and is not carried out by a qualified person.  
No nos hacemos responsables de accidentes si la instalación de los muebles no se realiza de acuerdo con los procedimientos de este Manual y no es realizada por una persona calificada.