



JCM
movelaria

Rack Garra

Garra TV Stand

Mesa de TV Garra



Cupom: JCM30









Indicamos que a montagem dos produtos seja realizada com parafusadeira eléctrica e por um montador profissional.
We recommend that a professional furniture assembler assemble the product by using a cordless screwdriver.
Se recomienda que un montador de muebles profesional realice el montaje del producto con un destornillador eléctrico.

AVISO: Não nos comprometemos pelo mal-uso, montagem e fixação do produto à parede. Portanto, não somos responsáveis por danos e quedas do produto, eletrônicos e pertences neles contidos. É importante o uso de brocas e ferramentas compatíveis na montagem.
NOTICE: The company is not responsible for the misuse, assembly, and wall fixation, as well as the damages and falls that the products, electronics, and belongings therein might suffer. It is important to use suitable drills and tools to assemble the product.
ATENCIÓN: La empresa no se responsabiliza del mal uso, montaje y fijación del producto a la pared, así como de daños y caídas del producto, electrónicos u objetos. Es importante el uso de taladros y herramientas compatibles con el montaje.

Dica: para evitar possíveis avarias, use a embalagem do produto como apoio durante a montagem.
Tip: to avoid damages, use the product packaging as a base during the assembly.
Pista: para evitar daños, use el envase del producto como apoyo durante el montaje.

RELAÇÃO DE FERRAGENS | HARDWARE LIST | LISTADO DE HERRAJES

CALÇO DOBRADIÇA 5mm	(B)	5mm HINGE MOUNTING PLATE	(B)	BASE DE BISAGRA 5 mm	(B)		02
CONEXÃO ANGULAR 2 FUROS	(C)	2-HOLE CORNER BRACKET	(C)	SOPORTE ANGULAR 2 AGUJEROS	(C)		05
DOBRADIÇA ALTA 26mm	(D)	26mm HALF-OVERLAY HINGE	(D)	BISAGRA ACODADA 26 mm	(D)		02
PARAFUSO CHP CHA BC 3,5x14	(E)	3.5x14 FLAT-HEAD SCREW	(E)	TORNILLO CABEZA PLANA 3,5x14	(E)		18
PARAFUSO ESTR CHA PHI ZP 5x40	(F)	5x40 FLAT-HEAD SCREW	(F)	TORNILLO CABEZA PLANA 5x40	(F)		08
PARAFUSO 7x60	(G)	7x60 SCREW	(G)	TORNILLO 7x60	(G)		05
PARAFUSO MINIFIX	(H)	MINIFIX BOLT	(H)	PERNO MINIFIX	(H)		08
PIÑO SUPORTE PRATELEIRA	(I)	SHELF SUPPORT	(I)	SOPORTE DE REPISA	(I)		08
PREGO 8x8 C/C	(J)	8x8 NAIL	(J)	CLAVO 8x8	(J)		25
TAMBOR MINIFIX 12x10mm	(K)	12x10mm MINIFIX CAM LOCK	(K)	CAJA DEL MINIFIX 12x10 mm	(K)		08

RELAÇÃO DE PEÇAS | PARTS LIST | LISTADO DE PARTES

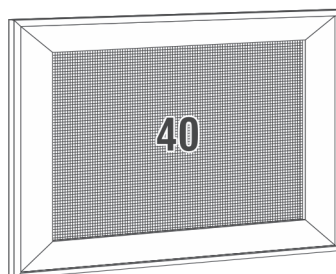
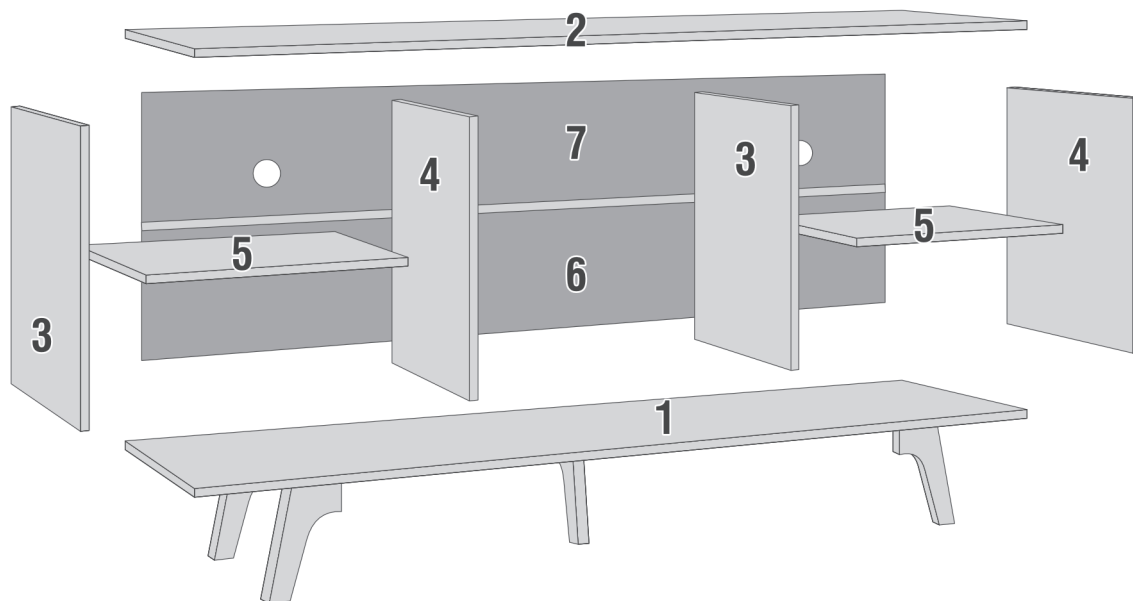

1 BASE
BOTTOM
BASE 1PC
1PC
1PZA



5 PRATELEIRA
SHELF
REPISA 2PCS
2PCS
2PZAS



2 TAMPO
TOP
TAPA 1PC
1PC
1PZA

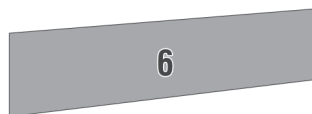

6 COSTAS INFERIOR
BOTTOM BACK PANEL
TRASERA INFERIOR 1PC
1PC
1PZA



3 LATERAL ESQUERDA | DIVISÃO DIREITA
LEFT SIDE | RIGHT DIVIDER 2PCS
2PCS
LATERAL IZQUIERDO | DIVISION DERECHA 2PZAS



7 COSTAS COM FURO
BACK PANEL WITH HOLE
TRASERA CON AGUJERO 1PC
1PC
1PZA



4 LATERAL DIREITA | DIVISÃO ESQUERDA
RIGHT SIDE | LEFT DIVIDER 2PCS
2PCS
LATERAL DERECHO | DIVISION IZQUIERDA 2PZAS

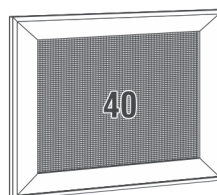

40 PORTA
DOOR
PUERTA 1PC
1PC
1PZA



50 PÉ
FEET
PATAS 5PCS
5PCS
5PZAS

Passo 01 INICIE A MONTAGEM PELA PEÇA 2, ENCAIXANDO AS PEÇAS 3 E 4 COM MINIFIX (H+K).
Step 01 START THE ASSEMBLY FROM PART 2, BY FASTENING PARTS 3 AND 4 WITH MINIFIX (H+K).
 Paso 01 EMPIECE A ARMAR POR LA PARTE 2, FIJANDO LAS PARTES 3 Y 4 CON MINIFIX (H+K).

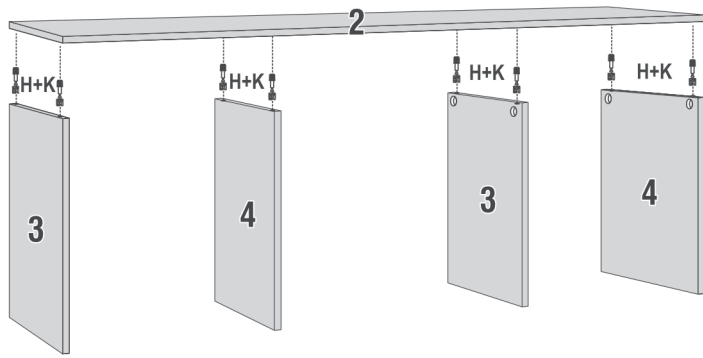

H=8  K=8 

Passo 02 PARAFUSE OS PÉS NA PEÇA 1 COM PARAFUSO 7x60 (G), USANDO TAMBÉM AS CONEXÕES ANGULARES (C+E).
Step 02 ATTACH THE FEET TO PART 1 WITH 7x60 SCREWS (G) AND CORNER BRACKETS (C+E).
 Paso 02 FIJE LAS PATAS A LA PARTE 1 CON TORNILLOS 7x60 (G) Y SOPORTES ANGULARES (C+E).

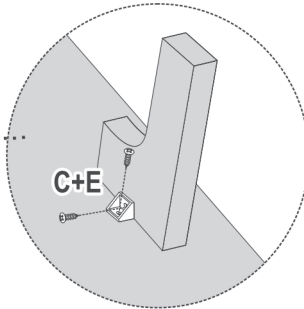
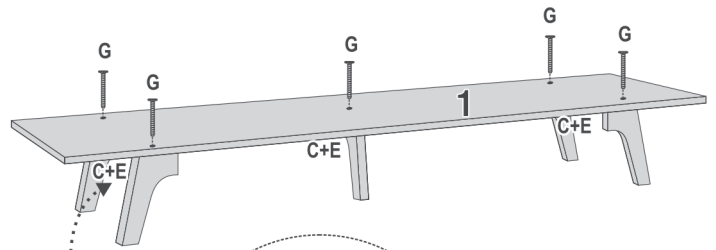

VISTA INFERIOR/INTERNA
 BOTTOM/INTERIOR VIEW
 VISTA DESDE ABAJO/INTERIOR

C=5  E=10 

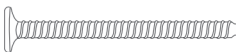
G=5 

Passo 03 PARAFUSE A PEÇA 1 NAS PEÇAS 3 E 4 COM PARAFUSO 5x40 (F).
Step 03 ATTACH PART 1 TO PARTS 3 AND 4 WITH 5x40 SCREWS (F).
 Paso 03 FIJE LA PARTE 1 A LAS PARTES 3 Y 4 CON TORNILLOS 5x40 (F).

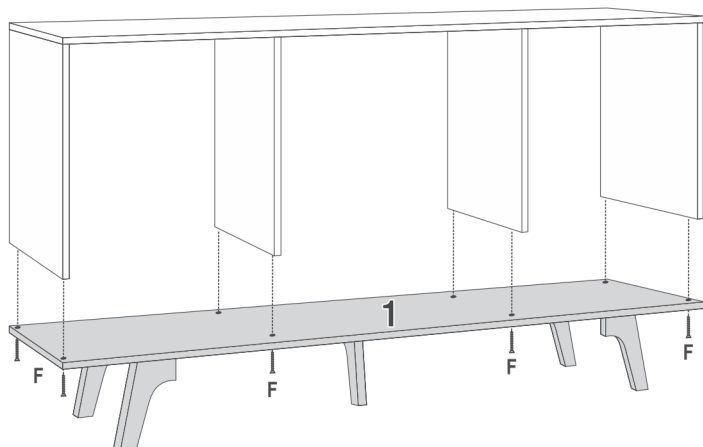

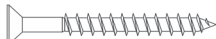
F=8 

Passo 04 PREGUE AS COSTAS COM PREGO 8x8 (J).
Step 04 ATTACH THE BACK PANELS WITH 8x8 NAILS (J).
 Paso 04 FIJE LAS TRASERAS CON CLAVOS 8x8 (J).

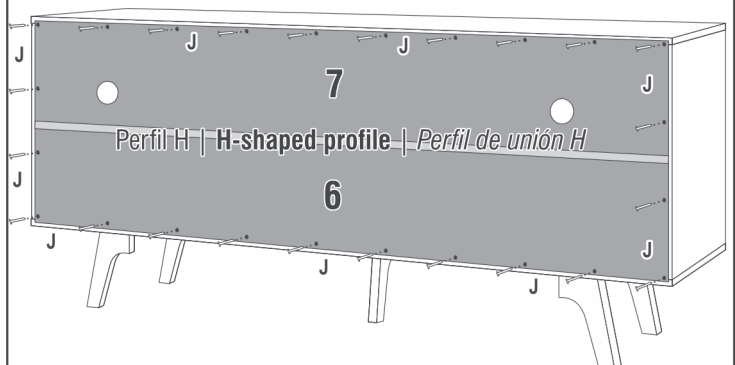

VISTA TRASEIRA
 BACK VIEW
 VISTA TRASERA

J=25 

Passo 05 MONTE A PORTA COM AS RESPECTIVAS FERRAGENS.

Step 05 ASSEMBLE THE DOOR WITH ITS HARDWARE.

Paso 05 ARME LA PUERTA CON SUS HERRAJES.

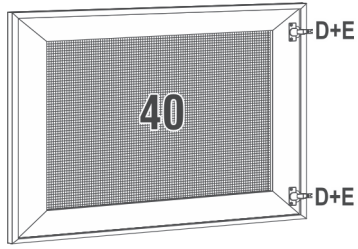

VISTA TRASEIRA
BACK VIEW
VISTA TRASERA

D=2  E=4 

Passo 06 INSTALE A PORTA, CONFORME DESENHO ABAIXO.

Step 06 INSTALL THE DOOR ACCORDING TO THE DRAWING BELOW.

Paso 06 INSTALE LA PUERTA SEGUN EL DIBUJO ABAJO.

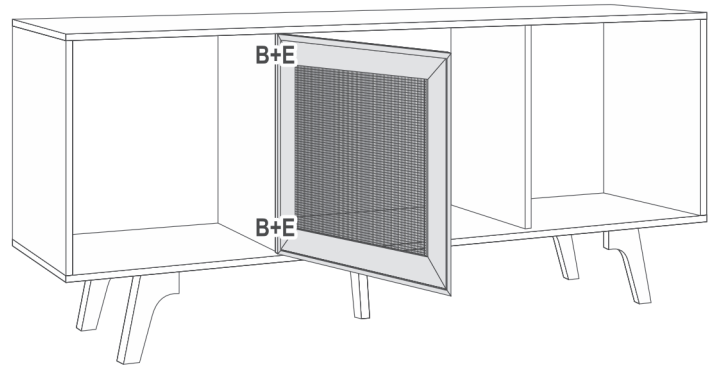

B=2  E=4 

Passo 07 COLOQUE AS PRATELEIRA 5 COM PINO SUPORTE PRATELEIRA (I).

Step 07 INSERT THE SHELVES AND THEIR SUPPORTS (I).

Paso 07 PONGA LAS REPISAS CON SUS SOPORTES (I).

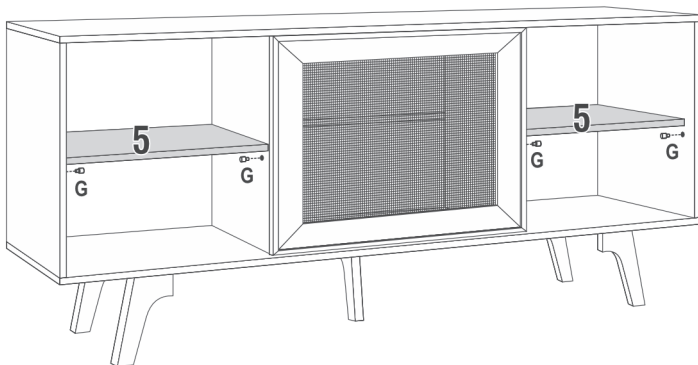

G=8 

Passo 08 PRODUTO MONTADO.

Step 08 PRODUCT ASSEMBLED.

Paso 08 PRODUCTO ARMADO.

