

Pessoas necessárias para a montagem



Tempo de montagem aproximado



Grau de dificuldade médio



Não utilizar químicos ou abrasivos na limpeza



Não ter contato com objetos cortantes



Pano umido com água seguido de pano seco

IMPORTANTE!

Respeitar os pesos máximos recomendados, considerando distribuição uniforme pela superfície das peças. Não expor o produto diretamente à luz solar e à umidade. GARANTIA: este produto tem garantia de 90 dias contra eventuais defeitos de fabricação, conforme Art. 26, inc. II do Código de Defesa do Consumidor. O direito à assistência técnica ou à substituição do produto ou de partes dele, dentro do período de garantia, é assegurado desde que observadas as instruções de montagem, instalação e conservação constantes deste manual e mediante a apresentação da Nota Fiscal de compra. O desgaste natural do móvel e problemas decorrentes de montagem incorreta e de uso inadequado não são cobertos pela garantia. A empresa se reserva o direito de modificar desenhos e especificações de seus produtos sem aviso prévio.

Ferramentas Recomendadas (Não inclusas e não fornecidas com o produto)



chave phillips



parafusadeira



martelo

Identificação de peças

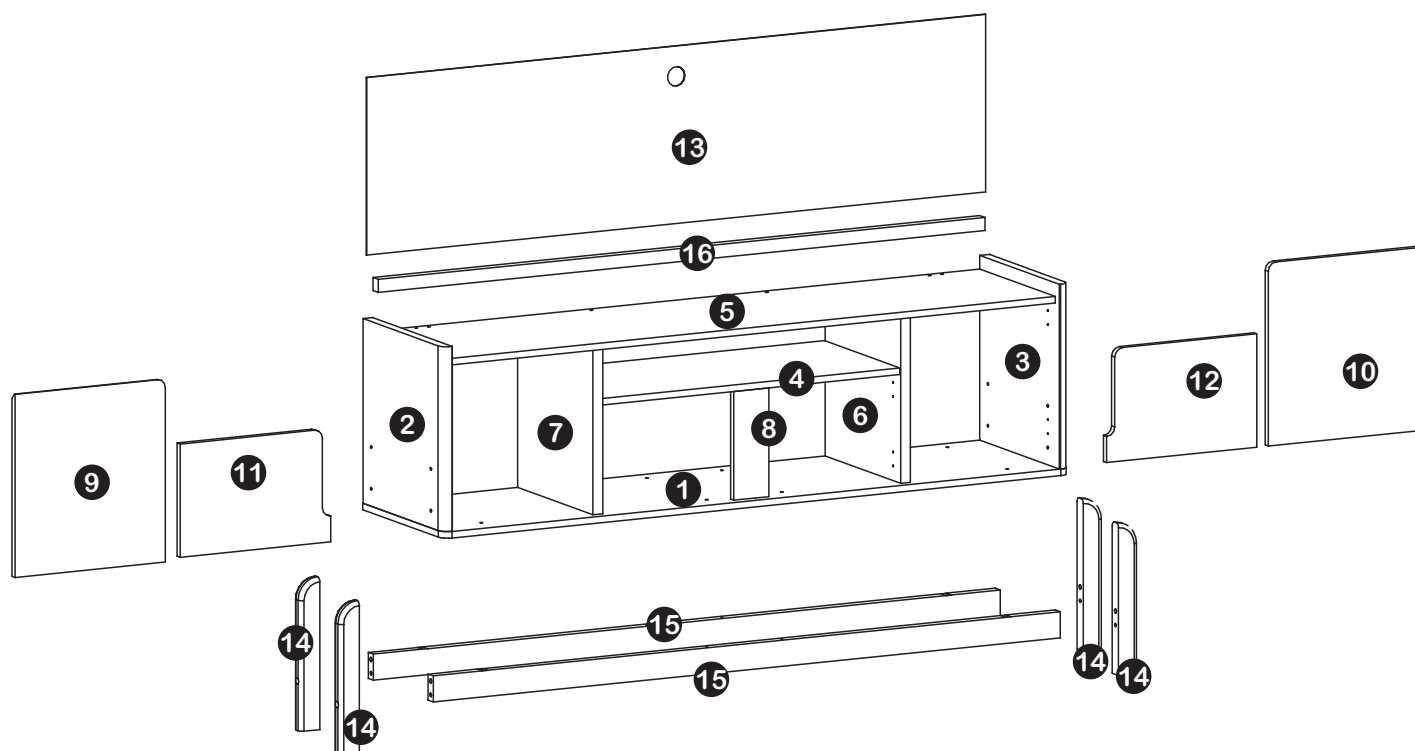

Descrição de peças

Dimensões

Quantidade

1	Base	1800 x 386 x 15 mm	1
2	Lateral Esquerda	425 x 384 x 15 mm	1
3	Lateral Direita	425 x 384 x 15 mm	1
4	Prateleira	755 x 361 x 15 mm	1
5	Tampo	1750 x 363 x 15 mm	1
6	Divisória Direita	378 x 362 x 25 mm	1
7	Divisória Esquerda	378 x 362 x 25 mm	1
8	Batente	250 x 90 x 15 mm	1
9	Porta Esquerda	421 x 484 x 15 mm	1
10	Porta Direita	421 x 484 x 15 mm	1
11	Porta Esquerda Central	384 x 280 x 15 mm	1
12	Porta Direita Central	384 x 280 x 15 mm	1
13	Fundo	1784 x 408 x 3 mm	1
14	Pé	350 x 50 x 30 mm	4
15	Travessa (Pé)	1800 x 60 x 25 mm	2
16	Travessa	1750 x 28 x 25 mm	1

Acessórios para montagem

A 18 un.

Cavilha Ø6x30mm



B 4 un.

Cavilha Ø10x40mm



C 10 un.

Parafuso Mini Fix

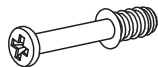

D 10 un.

Tambor Mini Fix



E 48 un.

Parafuso Ø4x14mm



F 16 un.

Parafuso Ø5.0x45mm

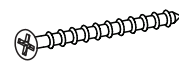

G 4 un.

Parafuso Ø1/4x2.1/2"

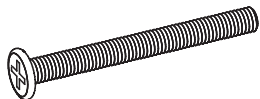

H 4 un.

Parafuso Ø4.5x35mm

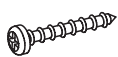

I 8 un.

Parafuso Ø5x50mm

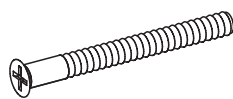

J 55 un.

Prego 10x10mm



K 4 un.

Sapata



L 16 un.

Tapa furo adesivo Ø12mm



M 4 un.

Tapa furo adesivo Ø20mm



N 4 un.

Moldado de Silicone Ø8mm



O 4 un.

Dobradiça Alta c/ Calço

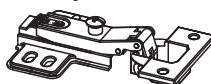

P 4 un.

Dobradiça Super Alta c/Calço



Q 4 un.



Usar a régua para medir os parafusos antes de aplicá-los (medidas em mm).



Passos para a montagem

1

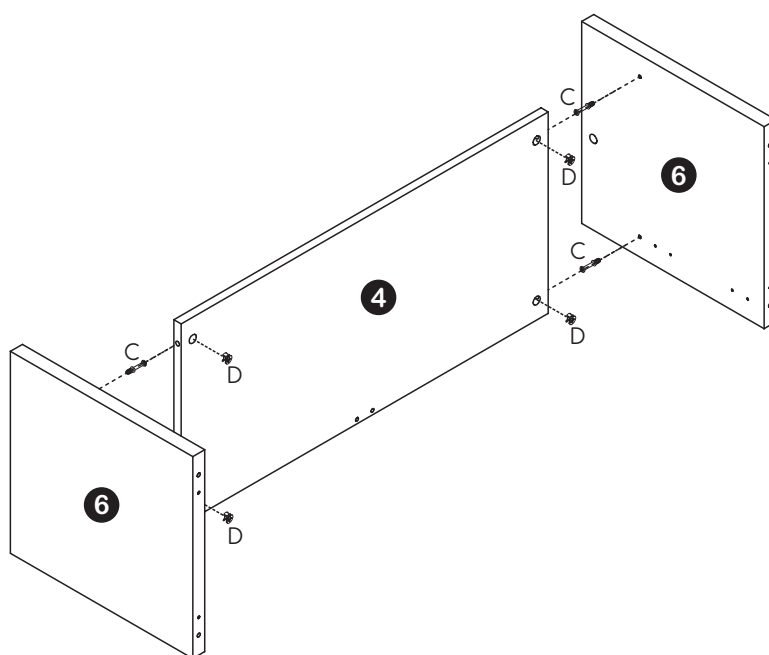

Passos para a montagem

1

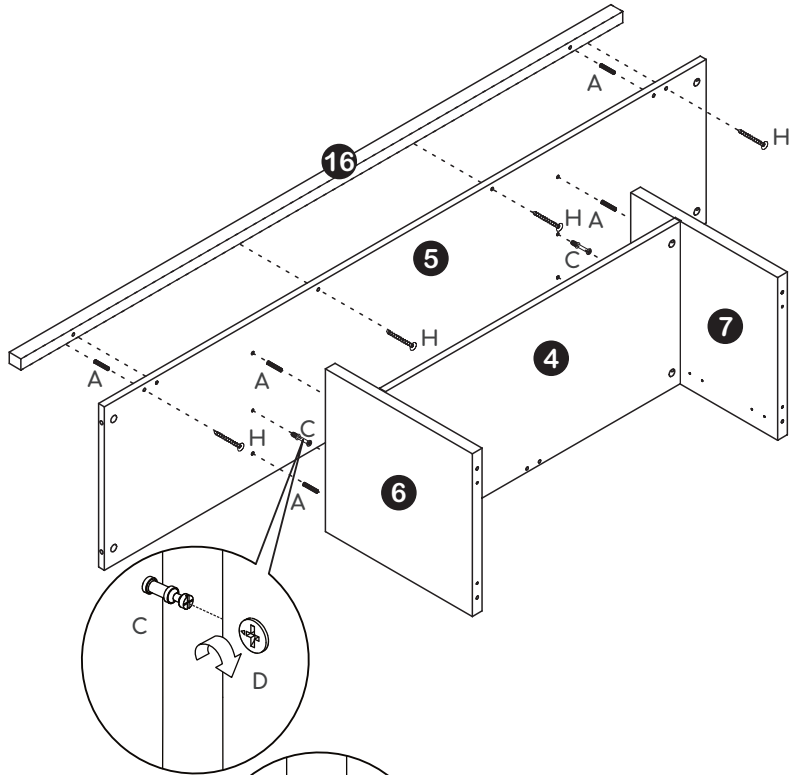

2

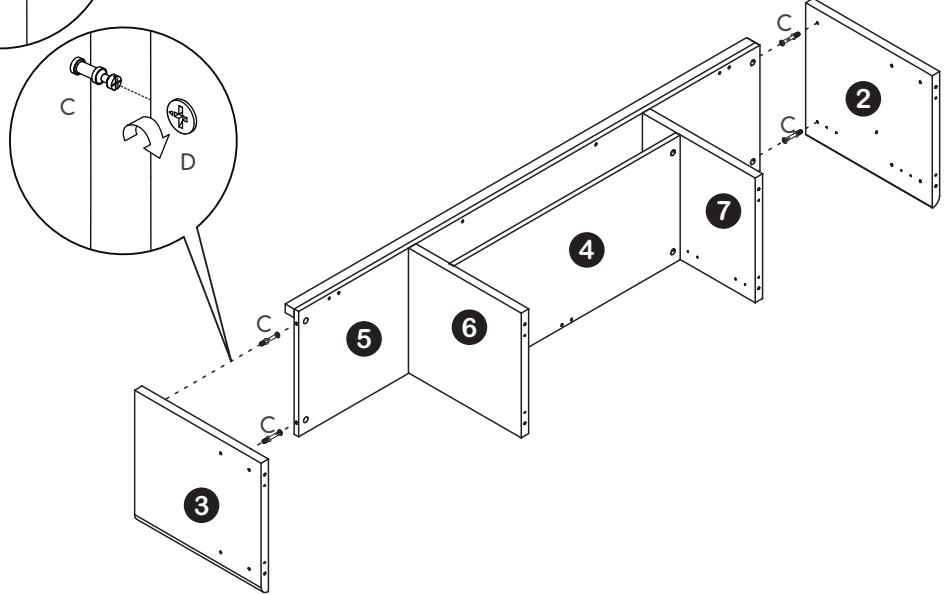

3

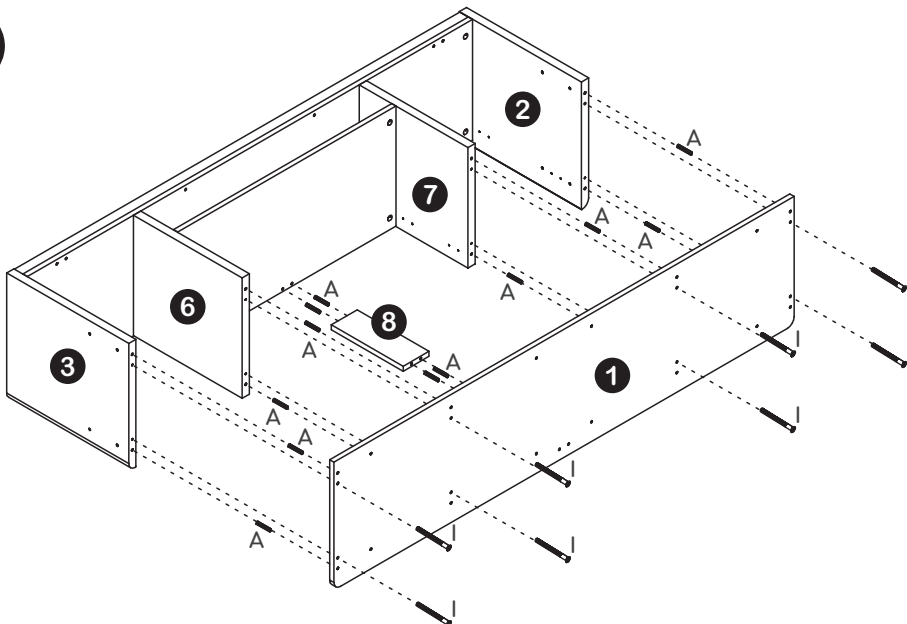

Passos para a montagem

4

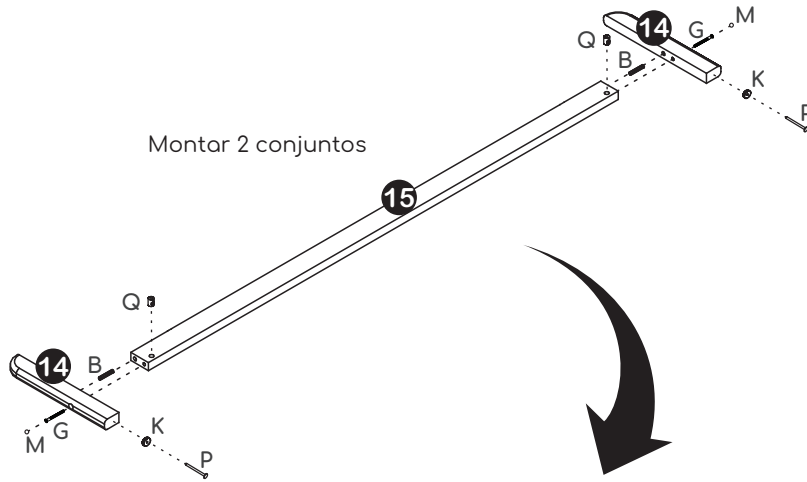

5

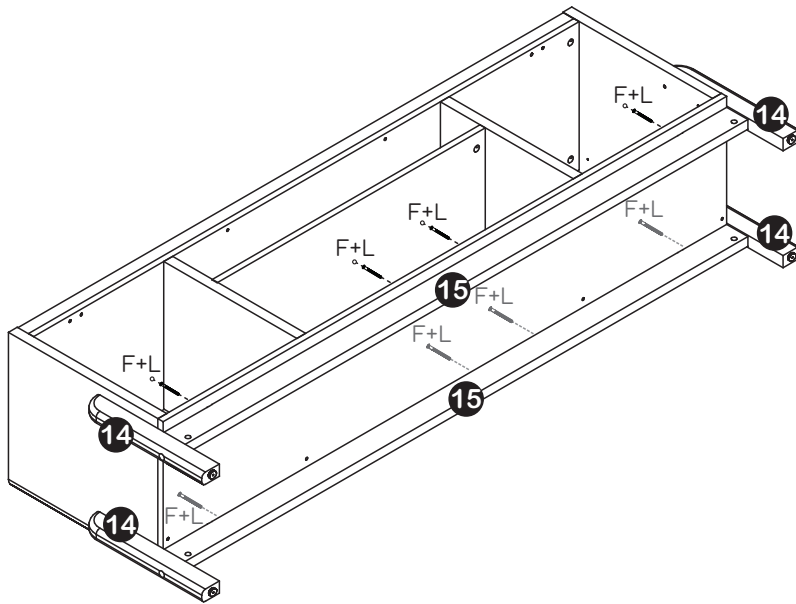

6

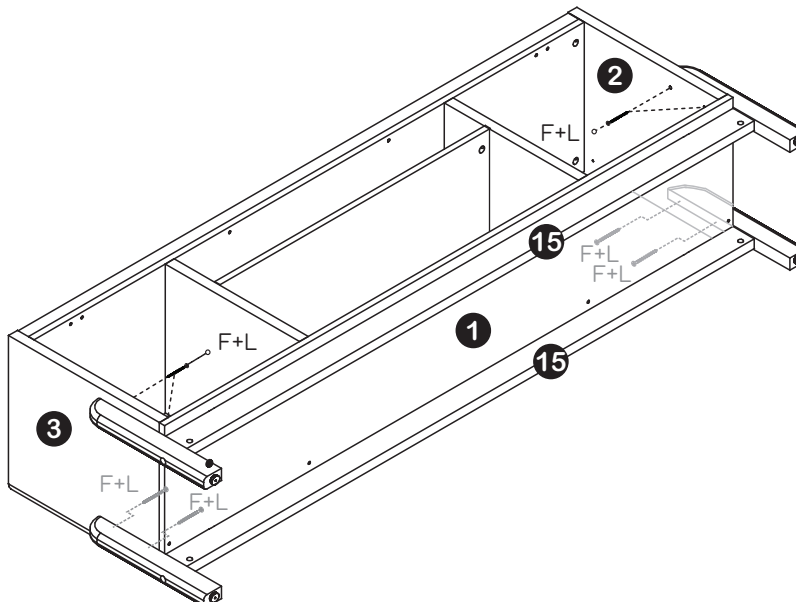

Passos para a montagem

7

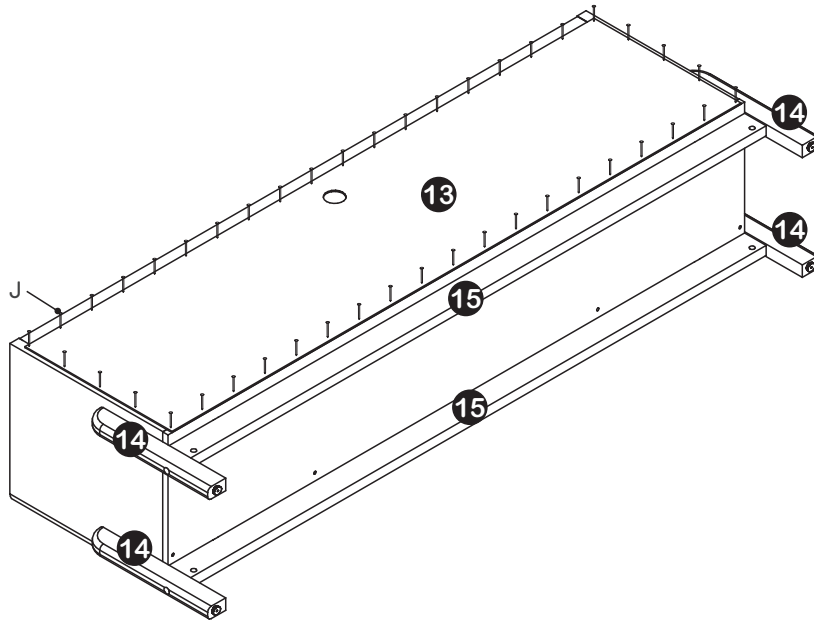

8

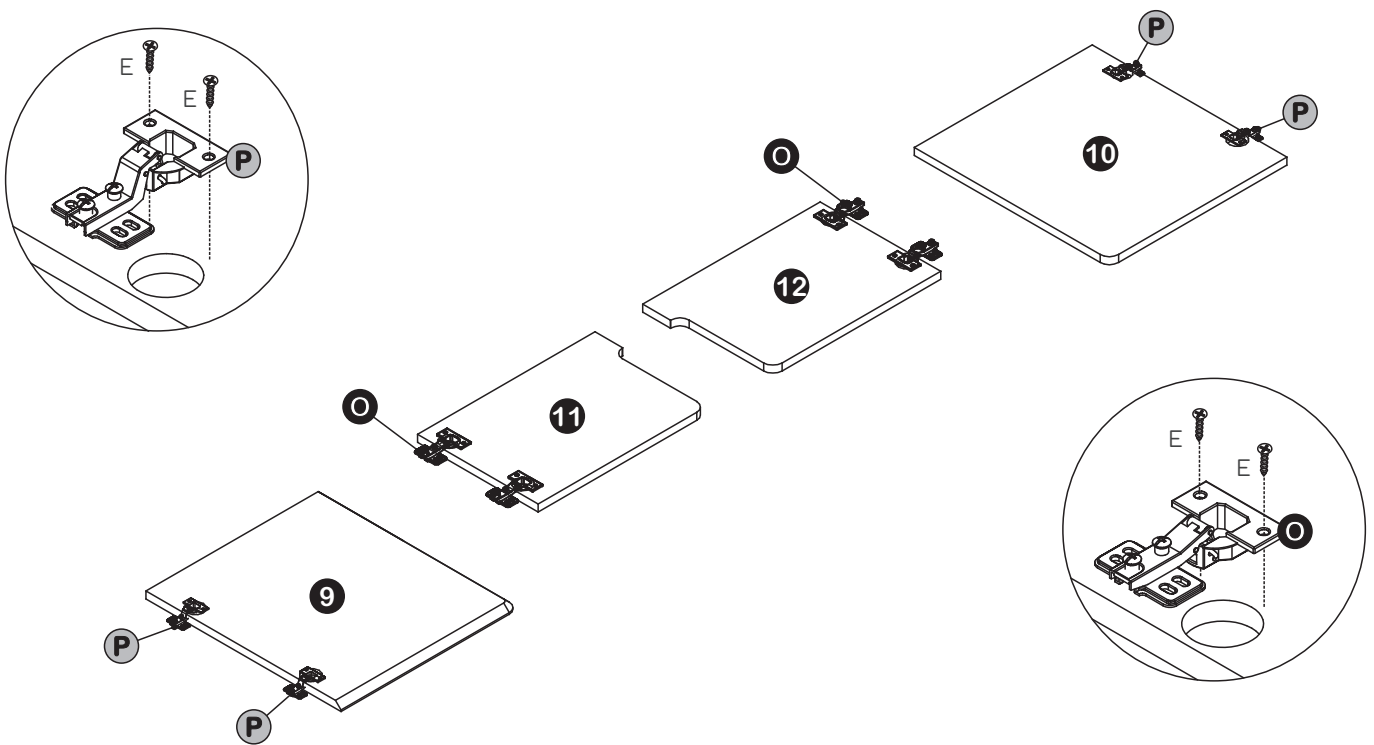

Passos para a montagem

11

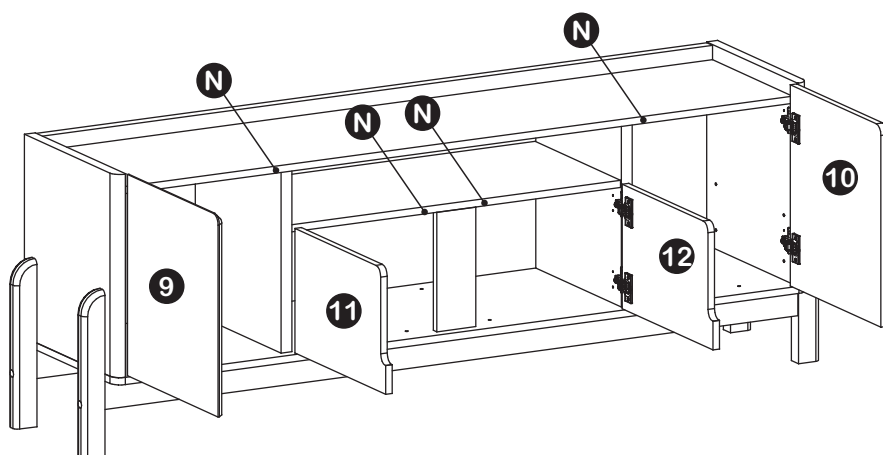

Ajuste das portas (se necessário)

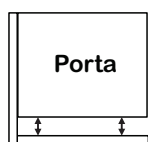

Ajuste de altura

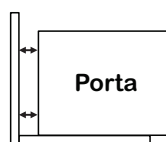
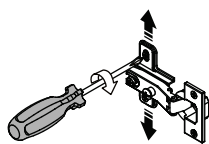

Ajuste lateral

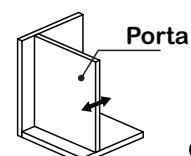
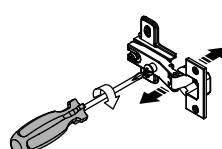

Ajuste de profundidade

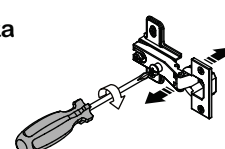

Carga Máxima Suportável

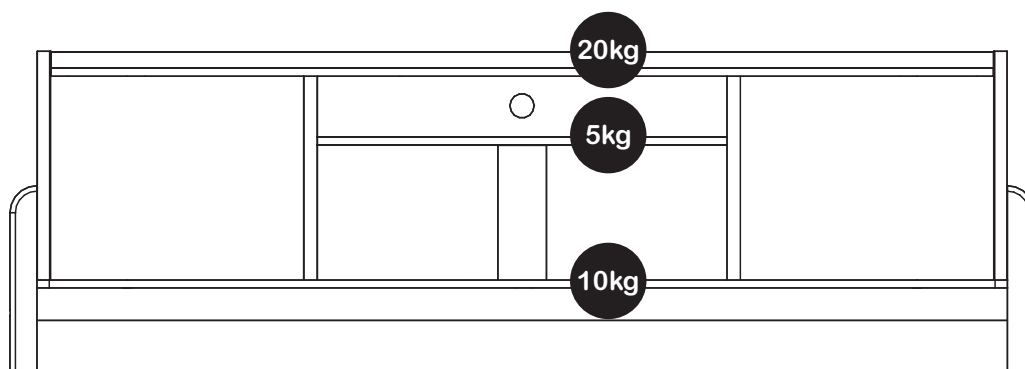

Casa D Indústria de Móveis Eireli.

Rua Doutor Ernani da Gama Corrêa, 3500 | Jardim Portal |
Cep 15133-286 | 17 3243-8300 | Mirassol - São Paulo - Brasil

www.casad.com.br