

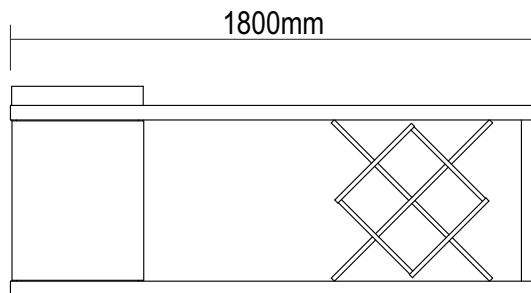

Rack Bar Madrid

Rack Madrid / Tv Stand Madrid

Versão 1.0 / Versión 1.0 / 1.0 Version

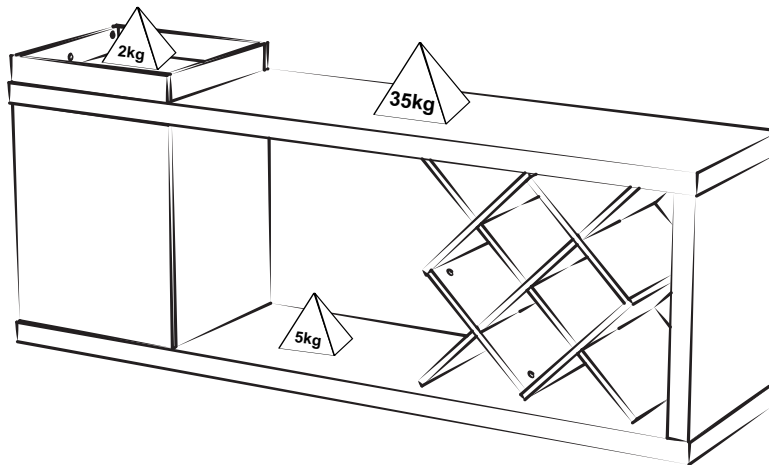

frente/frente/front

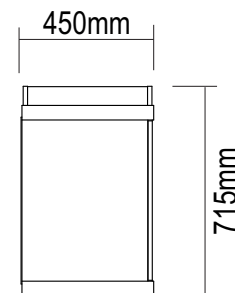

lateral/lado/side

Conservação e Limpeza - Conservación y Limpieza - Conservation and Cleaning

Não expor o produto ao sol, altas temperaturas e umidade. Não arrastar objetos sobre a superfície do móvel (ex.: TV, DVD, aparelho de som, objetos decorativos...) e manter em local seco e arejado. Para a limpeza, utilizar um pano seco e macio. Não é necessário o uso de materiais abrasivos ou álcool.

No exponga el producto a la luz solar, las altas temperaturas y la humedad. No arrastre los objetos a través de la superficie de la unidad (por ejemplo, TV, DVD, equipo de música, objetos de decoración ...) Mantener en un lugar fresco y seco.

Para la limpieza, utilizar un paño seco y suave. El uso de materiales abrasivos o del alcohol no es necesario.

Do not expose the product to sunlight, high temperatures and humidity. Do not drag objects across the surface of the unit (TV, DVD, stereo, decorative objects ...) keep it in a cool dry place. For cleaning, use a dry and soft cloth. Do not use abrasive materials or alcohol.

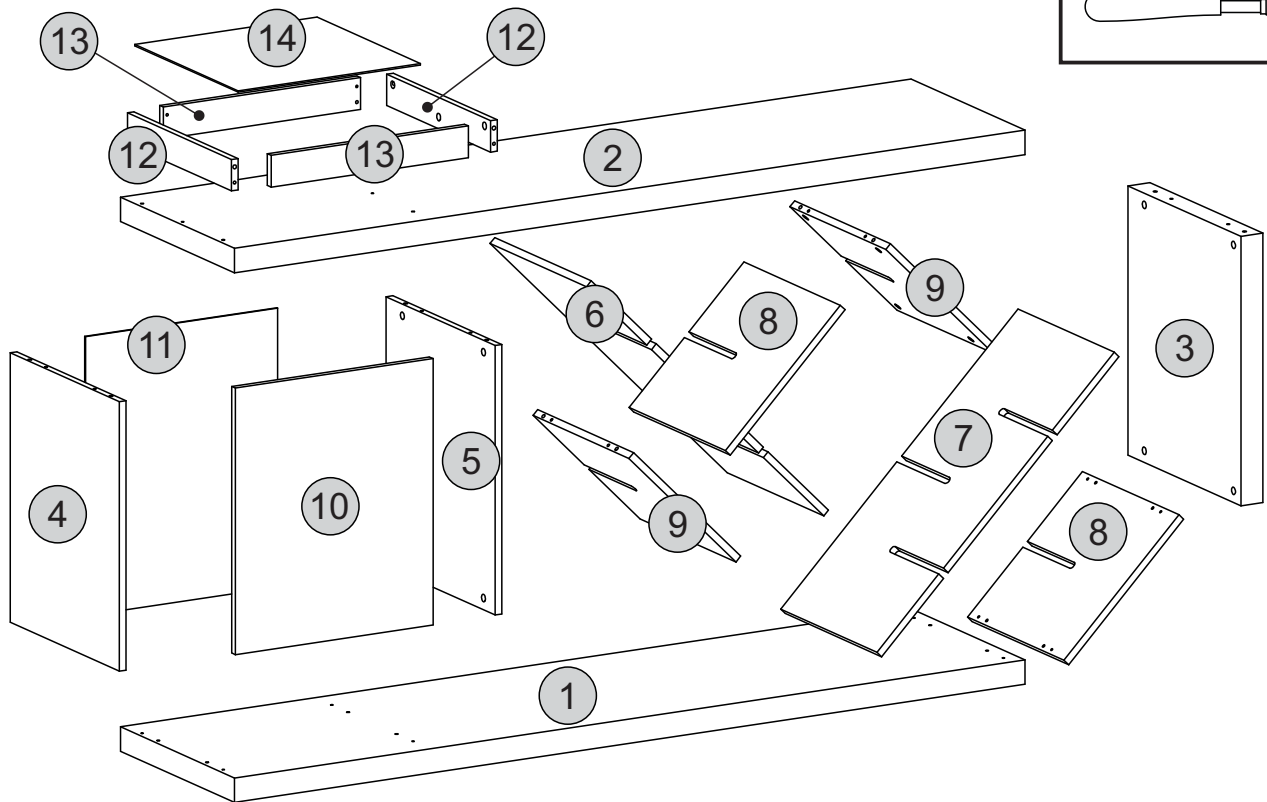
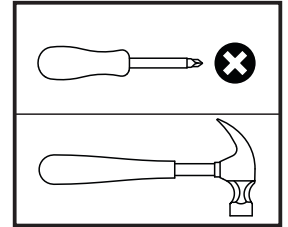





Descrição	Descripción	Description	Qty
1-Base (1800x450x50mm)	1-Base	1-Base	1
2-Tampo (1800x450x50mm)	2-Tapa	2-Top	1
3-Lateral Direita (550x445x50mm)	3-Lado Derecho	3-Right Side	1
4-Lateral Esquerda (550x430x15mm)	4-Lado Izquierdo	4-Left Side	1
5-Divisão (550x430x15mm)	5-División	5-Division	1
6-Divisão Esq. Garrafeiro (764x380x15mm)	6-División Izquierdo Bodega	6-Wine Cellar Left Division	1
7-Divisão Dir. Garrafeiro (764x380x15mm)	7-División Derecho Bodega	7-Wine Cellar Right Division	1
8-Tampo Garrafeiro (370x380x15mm)	8-Tapa Bodega	8-Wine Cellar Top	2
9-Base Garrafeiro (345x378x15mm)	9-Base Bodega	9-Wine Cellar Base	2
10-Porta (544x450x15mm)	10-Puerta	10-Door	1
11-Traseira (570x437x3mm)	11-Trasero	11-Back	1
12-Travessa Bandeja (410x64x15mm)	12-Travesaño bandeja	12-Tray crosspiece	2
13-Montante Bandeja (449x65x15mm)	13-Montante bandeja	13-Tray montante	2
14-Espelho (415x408x3mm)	14-Espejo	14-Mirror	1

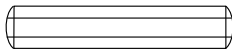
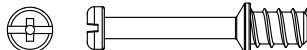
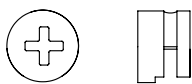

- O número na borda da peça corresponde ao manual.
 - Para retirada do número usar Lustra-Móveis, Alcool em Gel ou Borracha.
 -El número en el borde de la pieza coincide con el manual.
 -Use una goma de borrar blanca, alcohol en gel o lustrador para muebles para eliminar los números.
 -The number on the edge of the piece matches the manual.
 -Use a White eraser, Alcohol Gel or Furniture Polish to remove the numbers.

Lista de Materiais

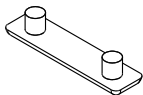
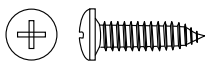
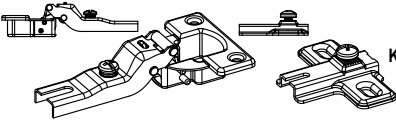
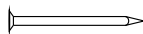
Lista de Materiales/ Hardware List

A		Cavilha / Tarugo / Dowel Ø6x30mm	28
B		Minifix / Minifix / Minifix Ø7x30mm	26
C		Tambor / Tambor / Minifix Cam Ø15x12mm	26
D		Tapa furo adesivo / Adhesivo / Hole Cover Ø18mm	26
E		Sapata Reta 12x48mm Plástico	08
F		Parafuso Tornillo / Screw Ø4,0x14mm CP	08
G		Kit Dobradiça Baixa Kit de bisagras menor Low Hinge Kit	02
H		Prego Nail / Clavo 8x8	20
I		Sapata Adesiva Zapato Adhesivo Adhesive Shoe	04

DICA PARA FIXAR MINIFIX

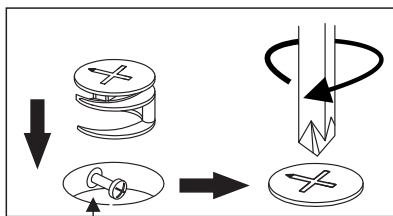

Cabeça do parafuso precisa estar no centro

Parafuso Minifix

Fixe o parafuso até o resalto encostar na superfície na peça. (veja o exemplo abaixo)

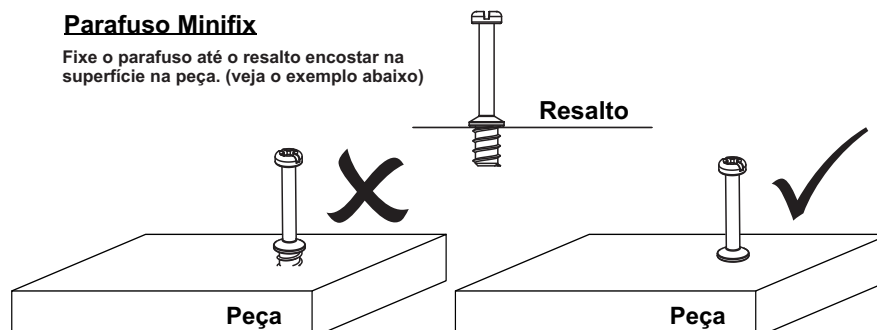

Passo 1

Paso/Step

PEÇA
Piece/Pieza

2 - TAMPO x1

FERRAGEM
Hardware/Herraje

B  08

FERRAMENTA
Tool/Herramienta

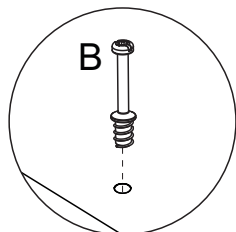
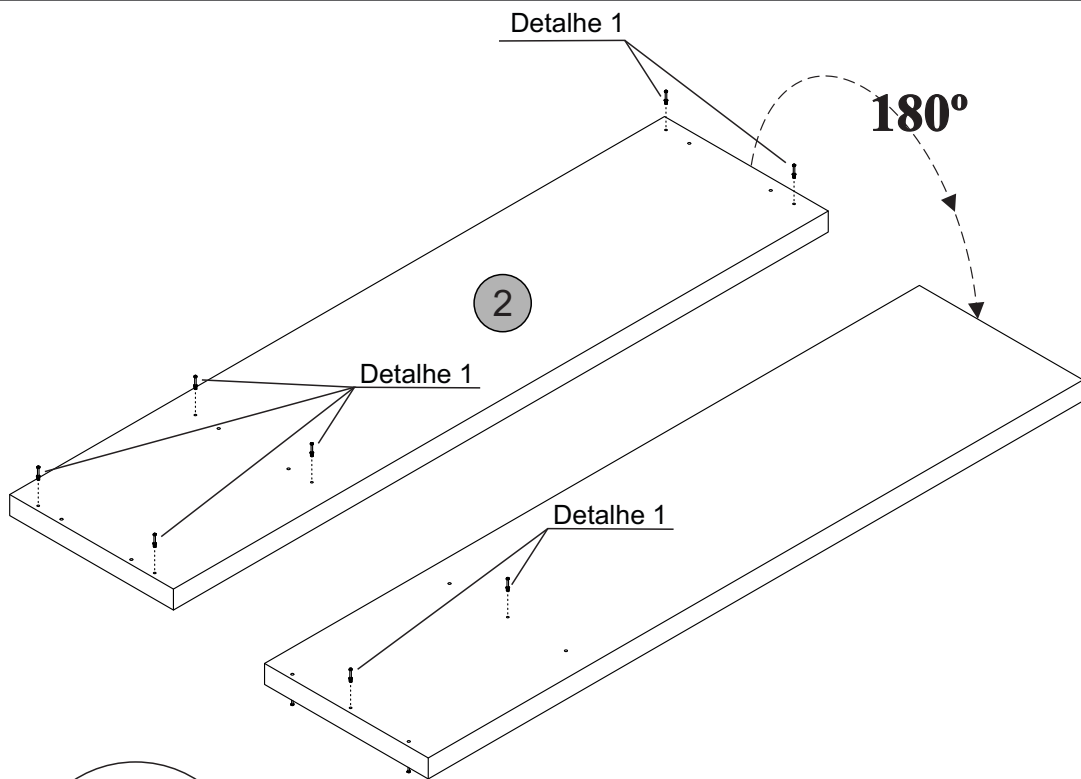
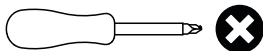

Detalhe 1
Detail/Detalle

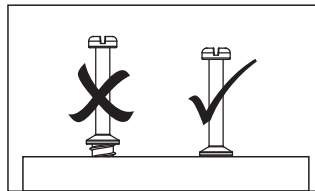

Passo 2

Paso/Step

PEÇA
Piece/Pieza

1 - TAMPO x1

FERRAGEM
Hardware/Herraje

B  06

E  08

FERRAMENTA
Tool/Herramienta

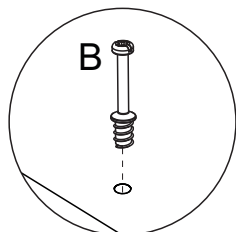
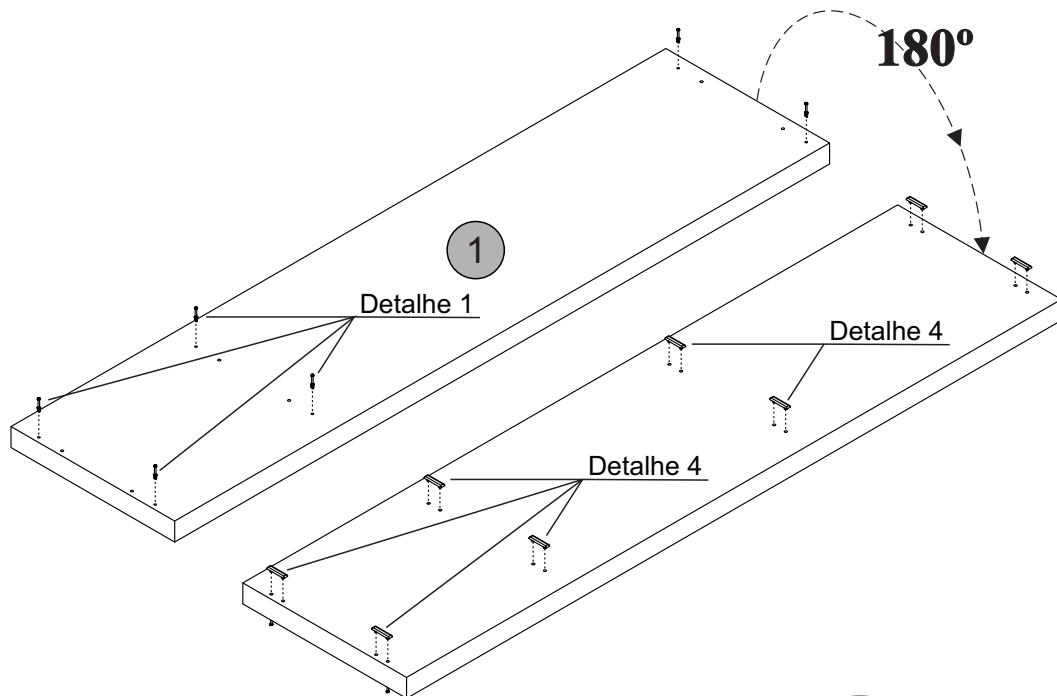
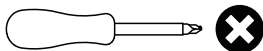

Detalhe 1
Detail/Detalle

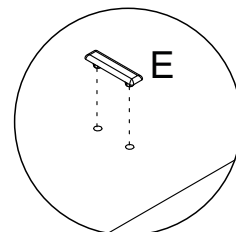
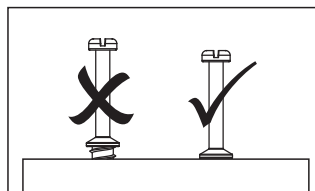

Detalhe 4
Detail/Detalle

Passo 3

Paso/Step

PEÇA
Piece/Pieza

4 - LATERAL ESQUERDA x1

FERRAGEM
Hardware/Herraje

A  04

F  04

G  02

FERRAMENTA
Tool/Herramienta

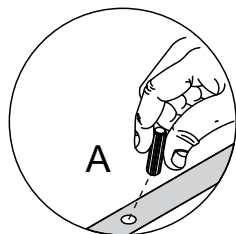
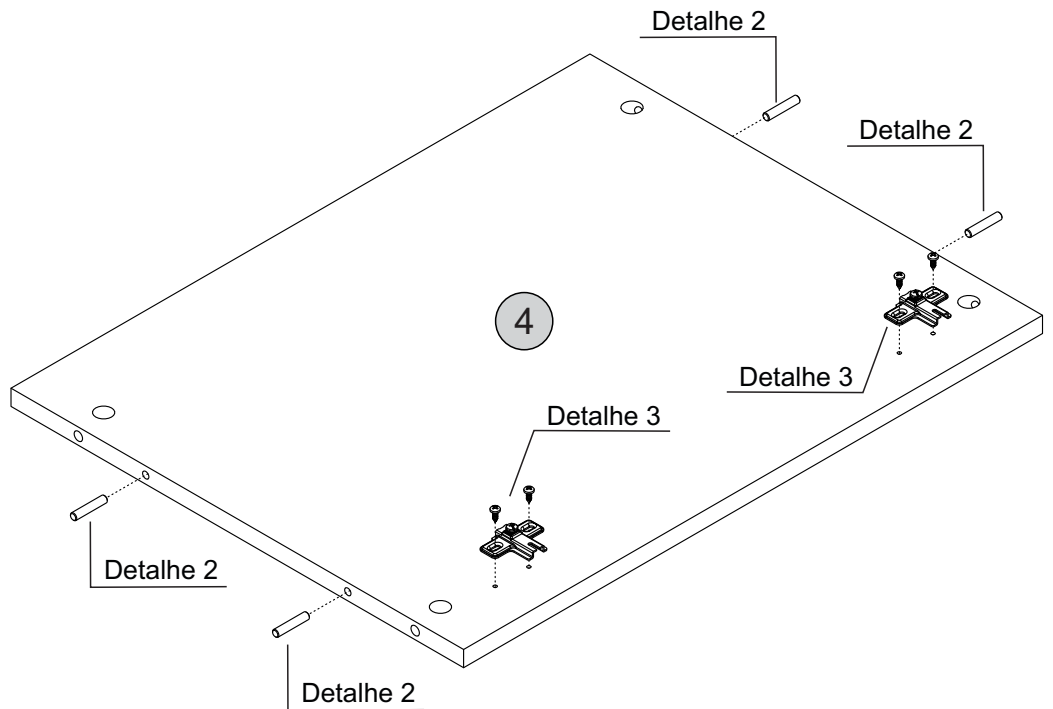
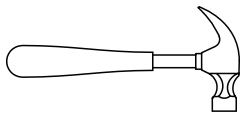
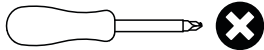

Detalhe 2
Detail/Detalle

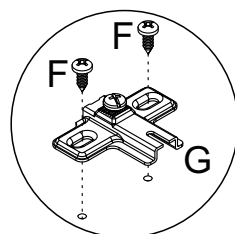

Detalhe 3
Detail/Detalle

Passo 4

Paso/Step

PEÇA
Piece/Pieza

3 - LATERAL DIREITA x1

FERRAGEM
Hardware/Herraje

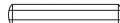
A  04

FERRAMENTA
Tool/Herramienta

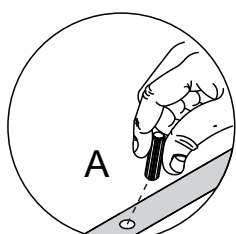
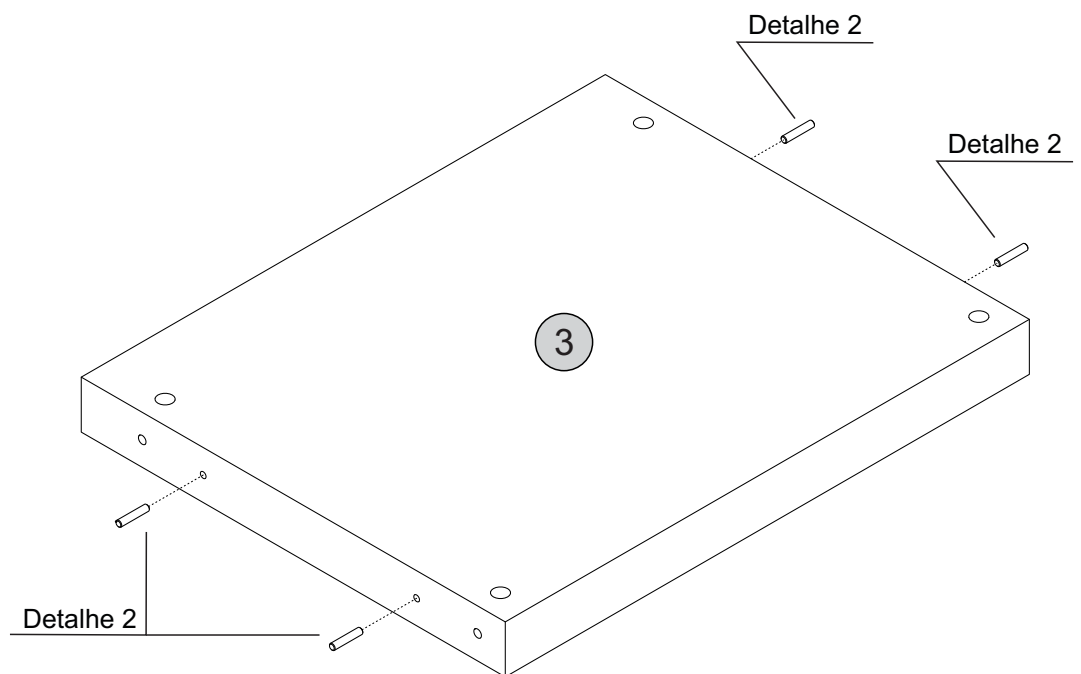
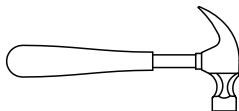

Detalhe 2
Detail/Detalle

Passo 5

Paso/Step

PEÇA
Piece/Pieza

5 - DIVISÃO x1

FERRAGEM
Hardware/Herraje

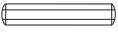
A  04

FERRAMENTA
Tool/Herramienta

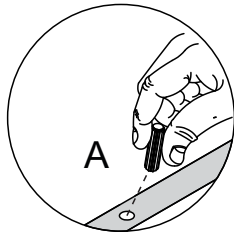
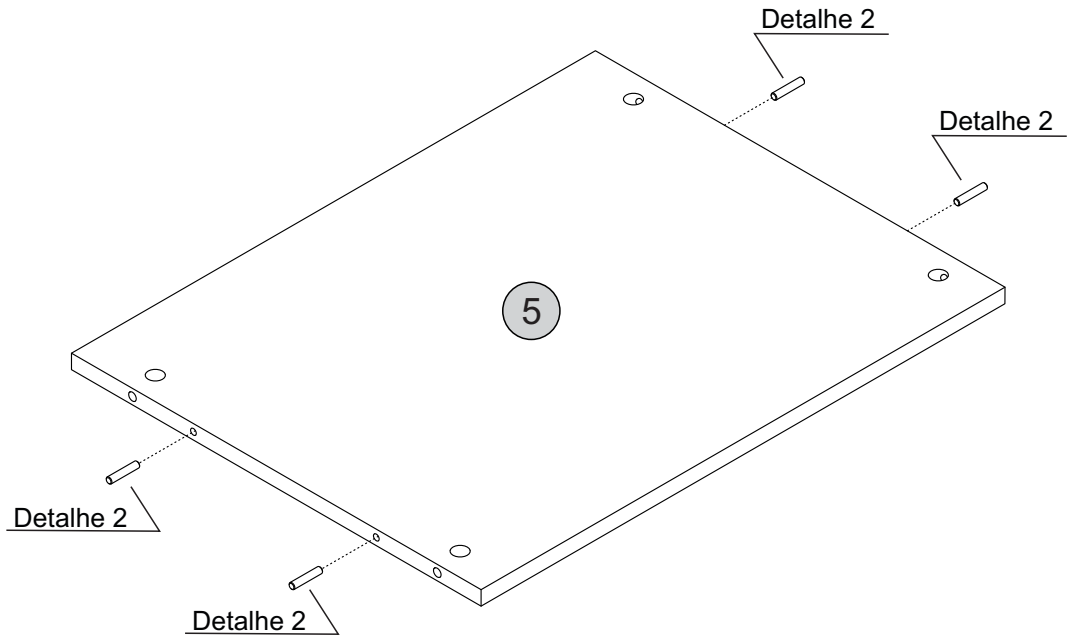
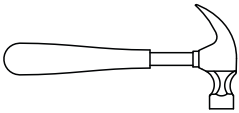

Detalhe 2
Detail/Detalle



Passo 6

Paso/Step

PEÇA
Piece/Pieza

10 - PORTA x1

FERRAGEM
Hardware/Herraje

F   04

G  02

FERRAMENTA
Tool/Herramienta

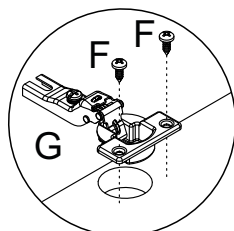
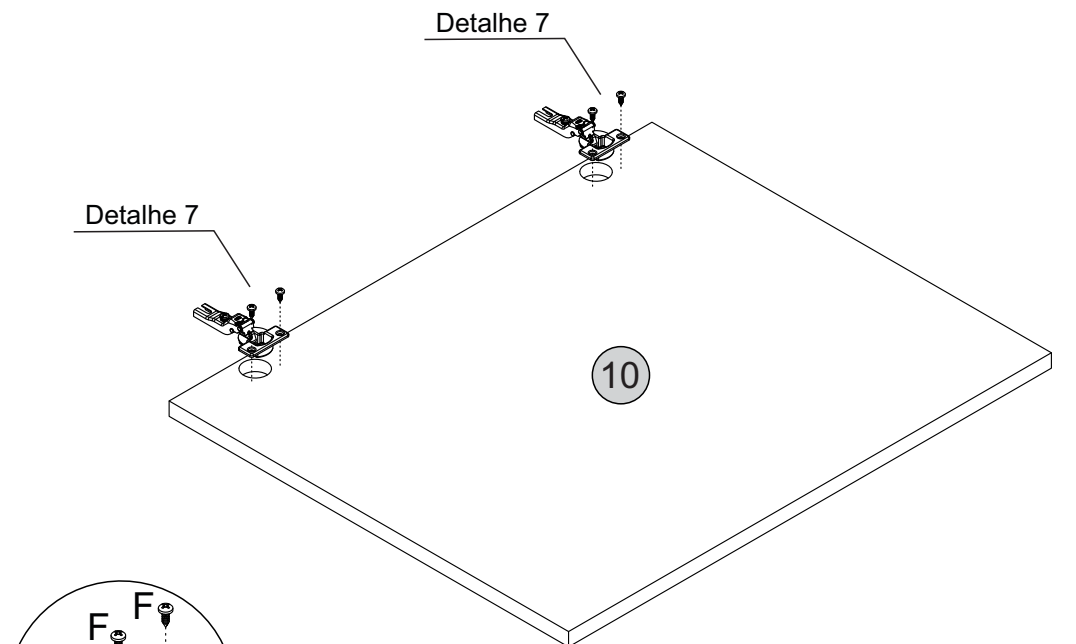
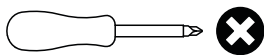

Detalhe 7
Detail/Detalle

Passo 7

Paso/Step

PEÇA
Piece/Pieza

12 - TRAVESSA BANDEJA x2

13 - MONTANTE BANDEJA x2

FERRAGEM
Hardware/Herraje

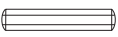
A  04

B  08

FERRAMENTA
Tool/Herramienta

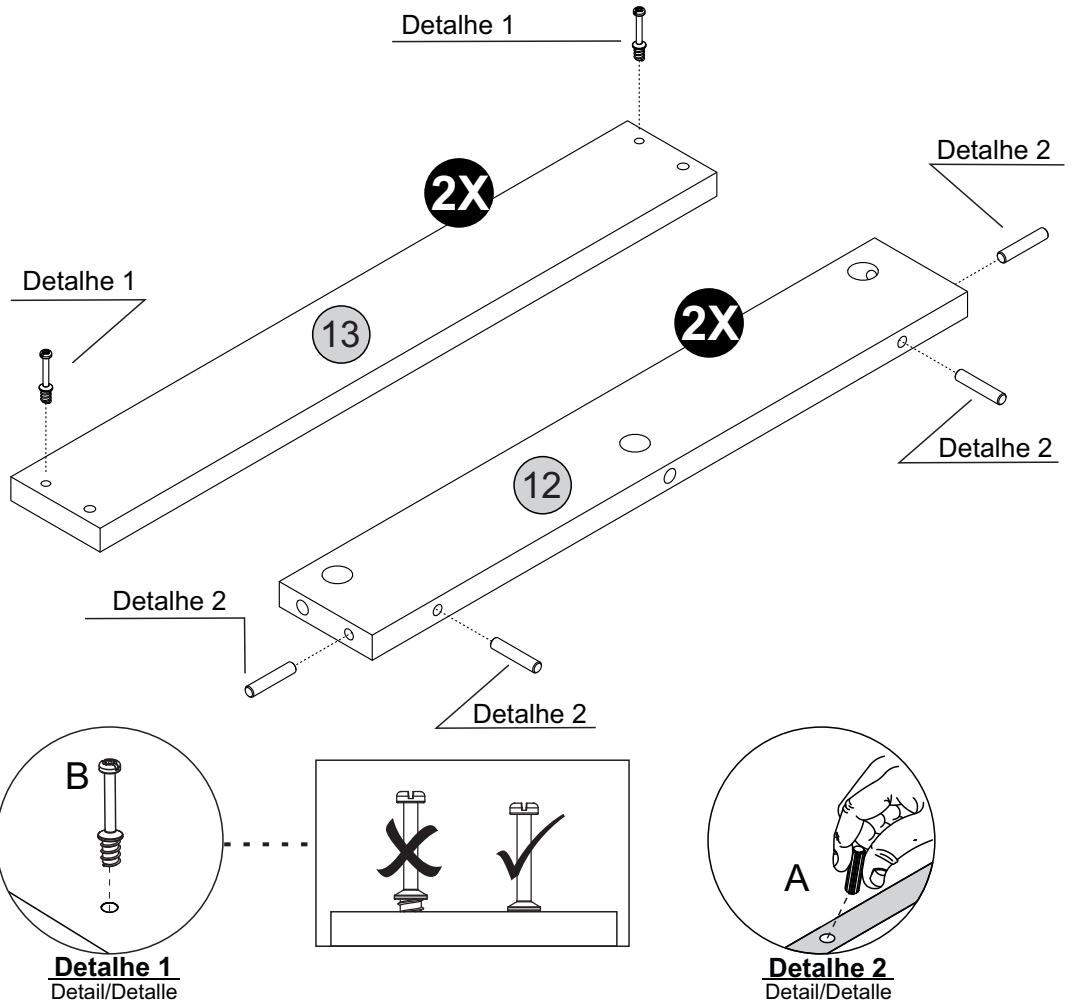
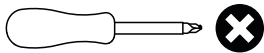
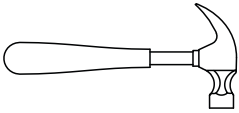

Passo 8

Paso/Step

PEÇA
Piece/Pieza

8 - TAMPO GARRAFEIRO x2

9 - BASE GARRAFEIRO x2

FERRAGEM
Hardware/Herraje

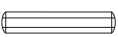
A  08

B  08

FERRAMENTA
Tool/Herramienta

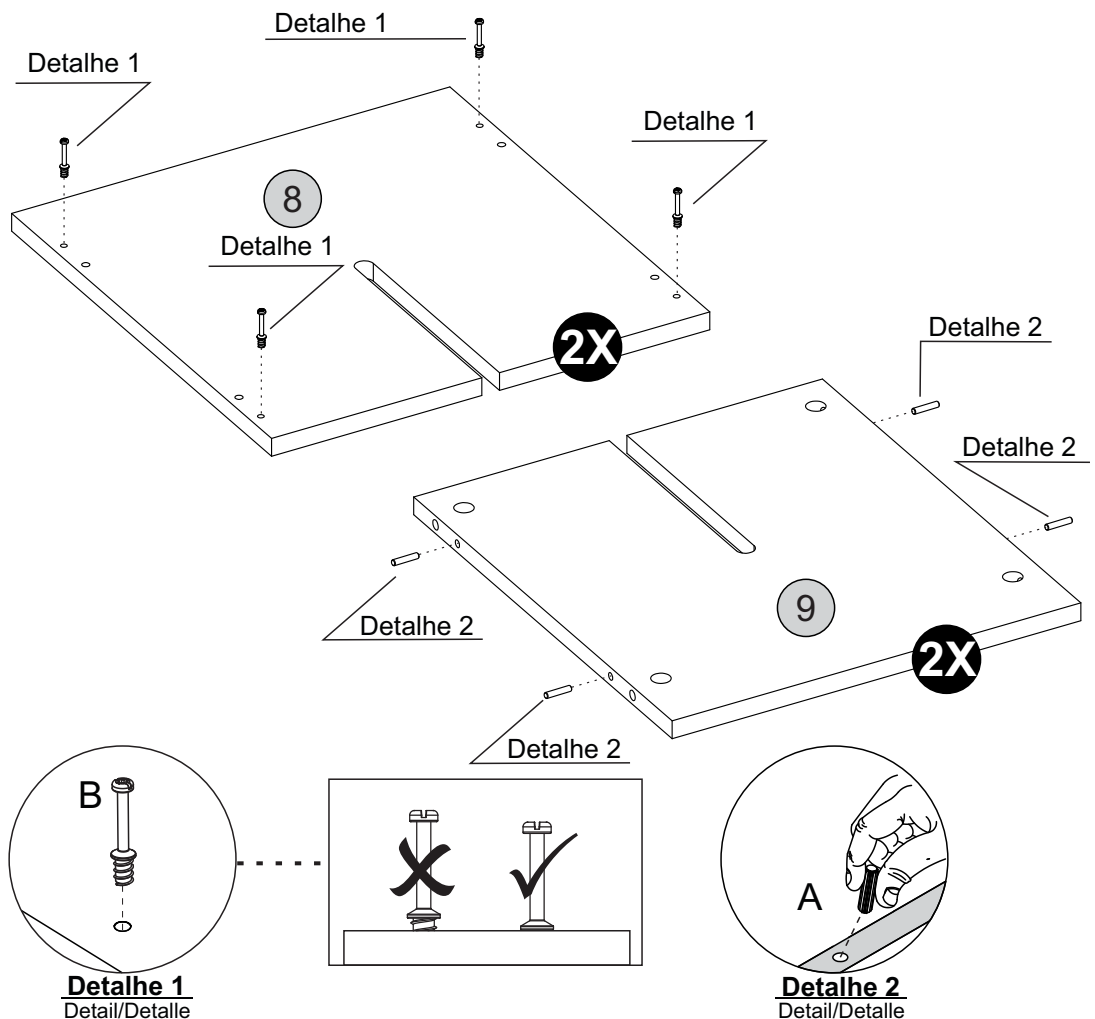
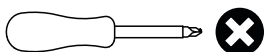
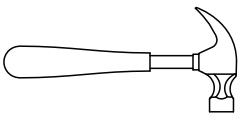

Passo 9

Paso/Step

PEÇA

Piece/Pieza

1 - BASE x1

3 - LATERAL DIREITA x1

4 - LATERAL ESQUERDA x1

FERRAGEM

Hardware/Herraje

C  04

D  04

FERRAMENTA

Tool/Herramienta

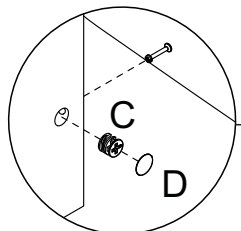
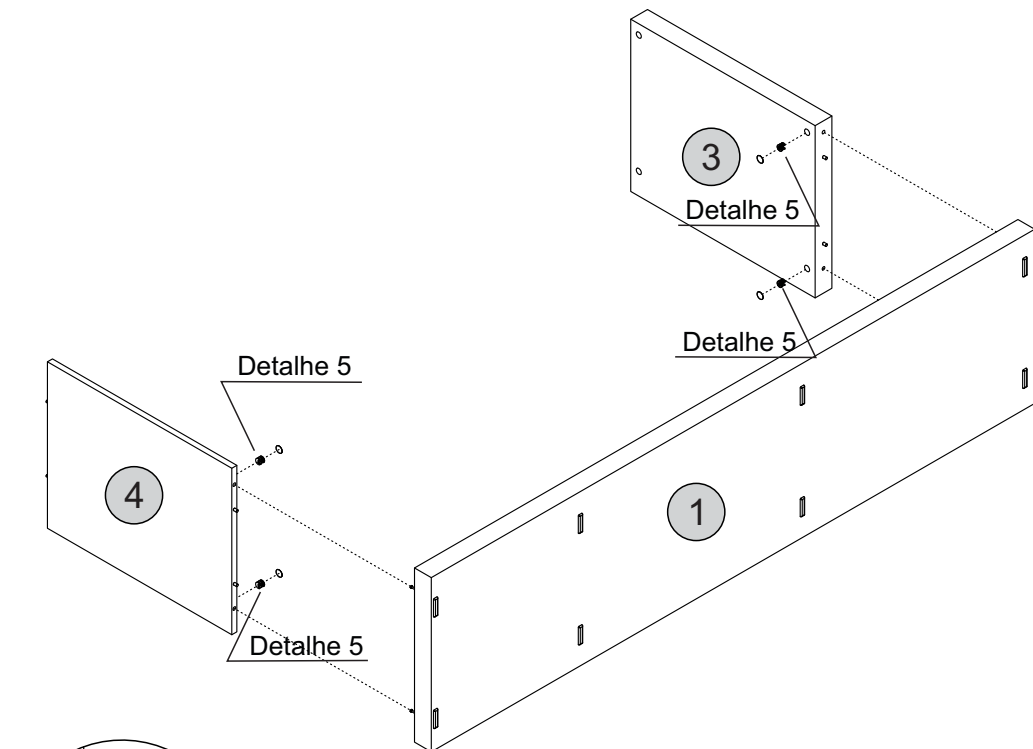
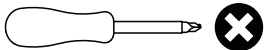

Detalhe 5
Detail/Detalle

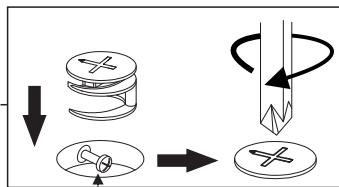

Cabeça do parafuso precisa estar no centro
La cabeza del tornillo debe estar en el centro
Screw head has to be in the center

Passo 10

Paso/Step

PEÇA

Piece/Pieza

5 - DIVISÃO x1

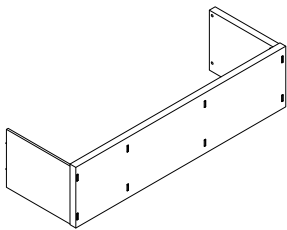

FERRAGEM

Hardware/Herraje

C  02

D  02

FERRAMENTA

Tool/Herramienta

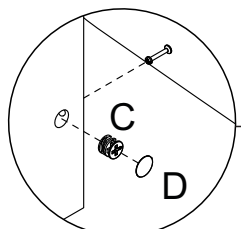
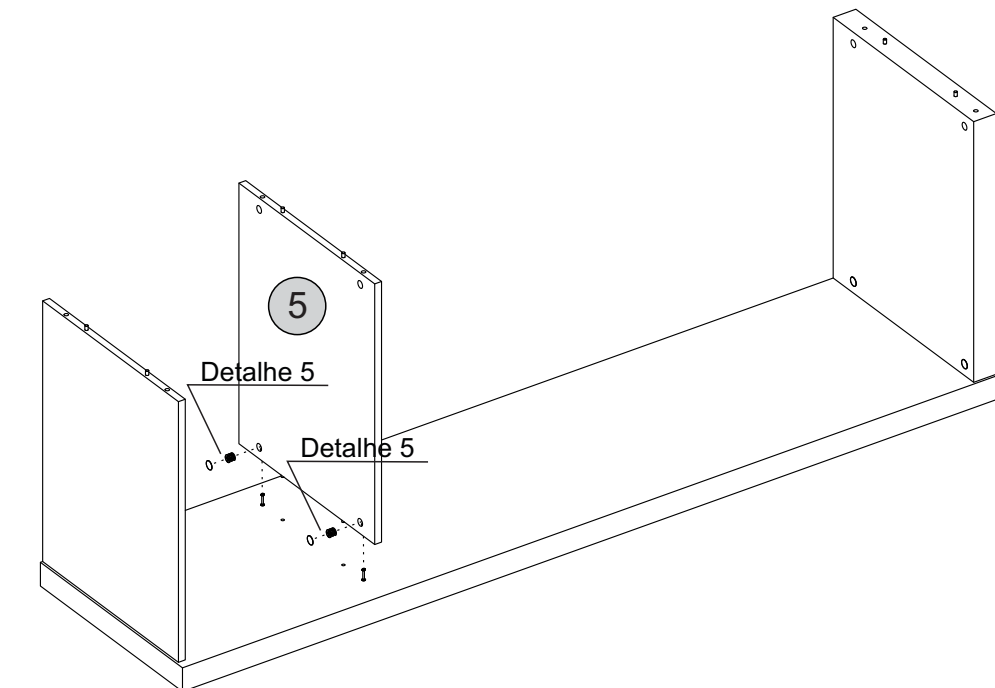
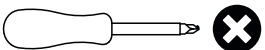

Detalhe 5
Detail/Detalle

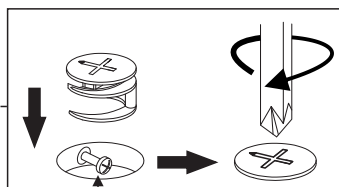

Cabeça do parafuso precisa estar no centro
La cabeza del tornillo debe estar en el centro
Screw head has to be in the center

Passo 11

Paso/Step

PEÇA
Piece/Pieza

2 - TAMPO x1

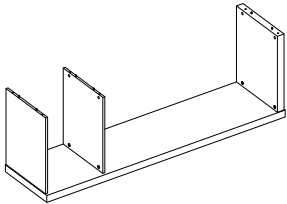

FERRAGEM
Hardware/Herraje

C  06

D  06

FERRAMENTA
Tool/Herramienta

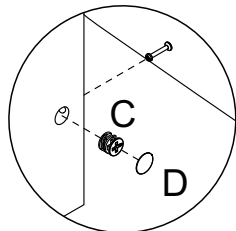
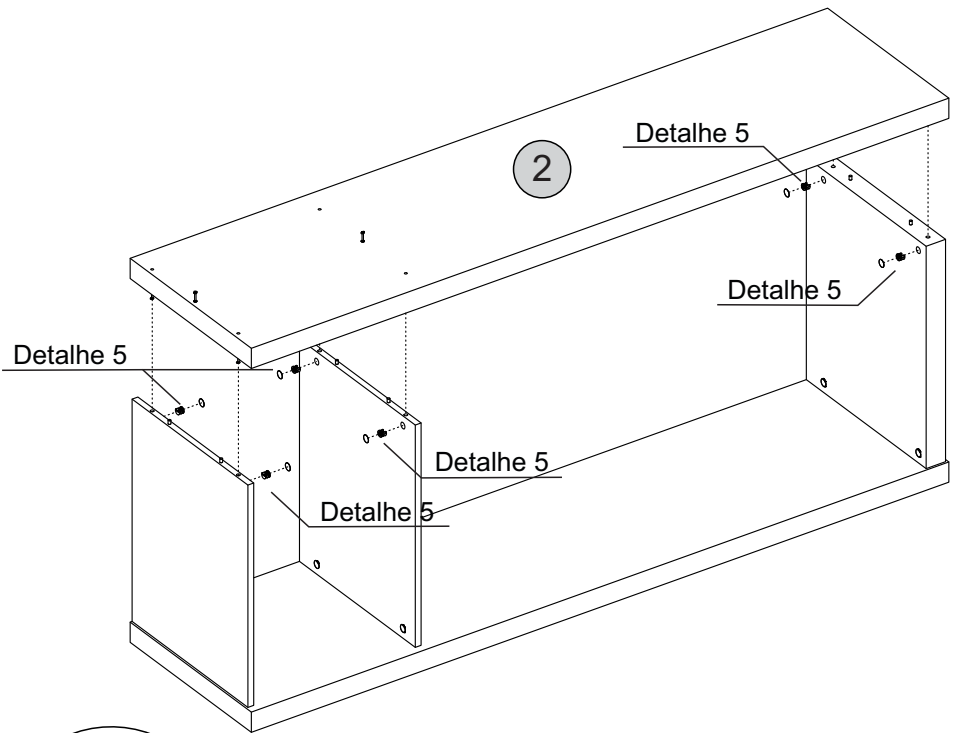
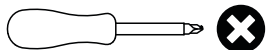

Detalhe 5
Detail/Detalle

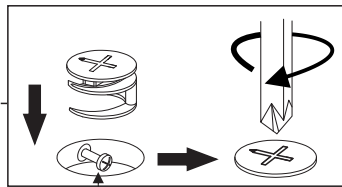

Cabeça do parafuso precisa estar no centro
La cabeza del tornillo debe estar en el centro
Screw head has to be in the center

Passo 12

Paso/Step

PEÇA
Piece/Pieza

11 - TRASEIRA x1

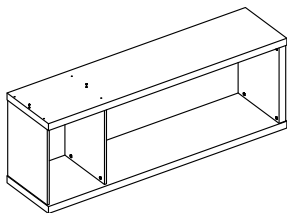

FERRAGEM
Hardware/Herraje

H  14

FERRAMENTA
Tool/Herramienta

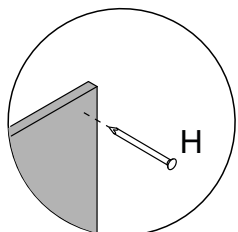
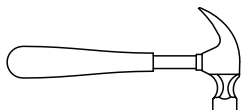

Detalhe 6
Detail/Detalle

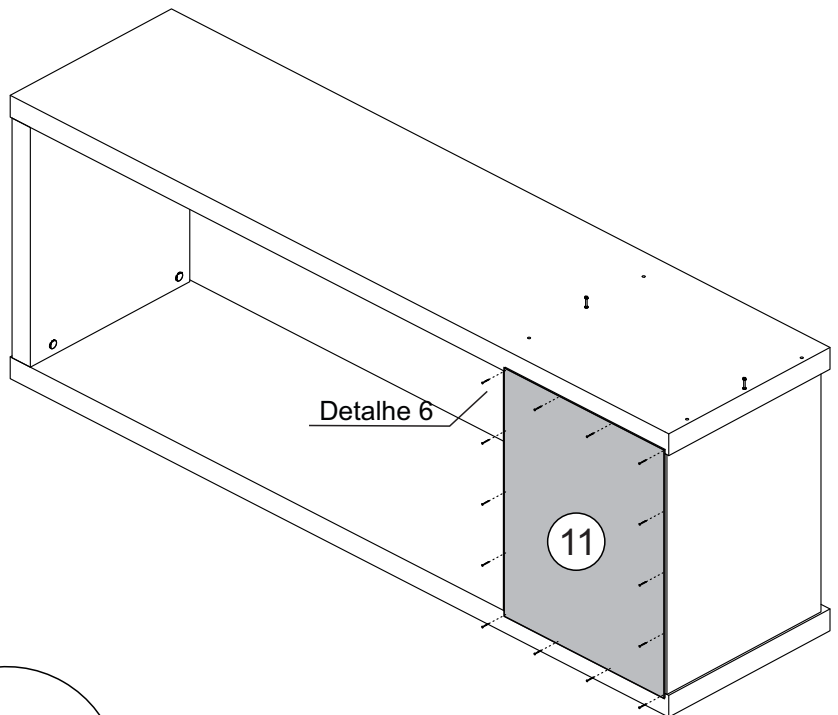

Passo 13

Paso/Step

PEÇA

Piece/Pieza

10 - PORTA x1

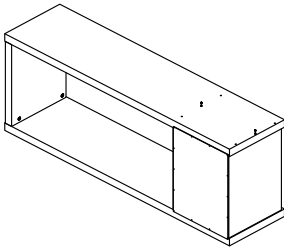

FERRAGEM

Hardware/Herraje

FERRAMENTA

Tool/Herramienta

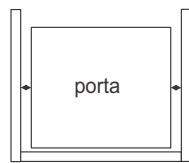
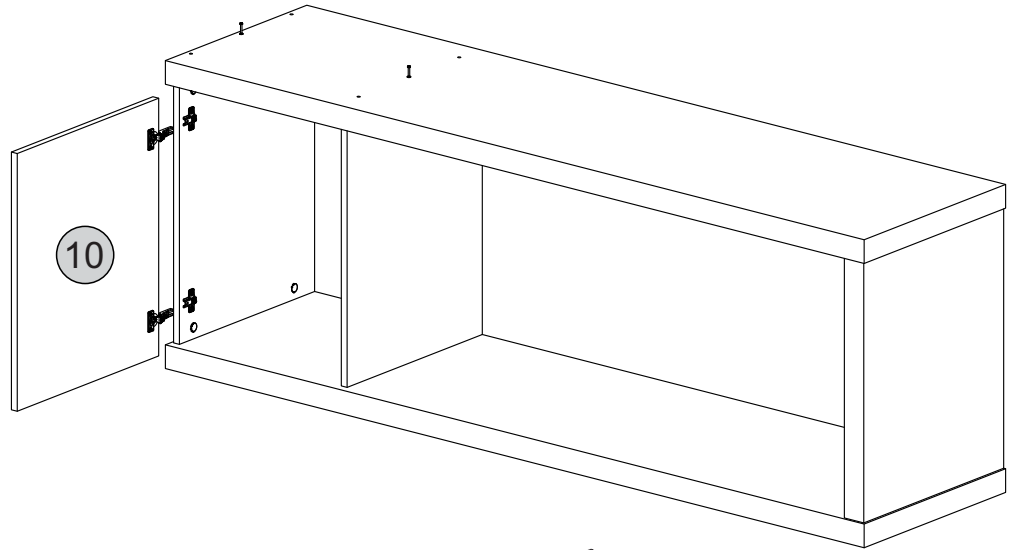
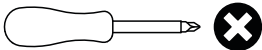

Ajuste de Largura

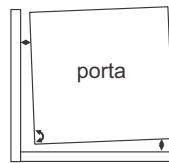

Ajuste Interno

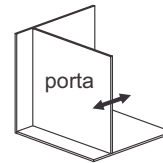

Ajuste de Profundidade

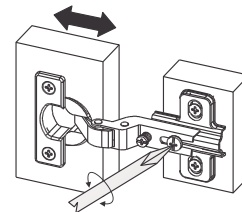
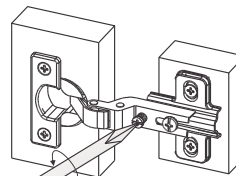
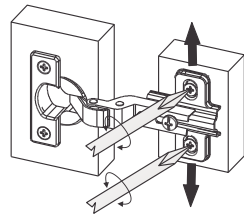

Passo 14

Paso/Step

PEÇA

Piece/Pieza

12 - TRAVESSA BANDEJA x2

13 - MONTANTE BANDEJA x2

FERRAGEM

Hardware/Herraje

C   04

D  04

FERRAMENTA

Tool/Herramienta

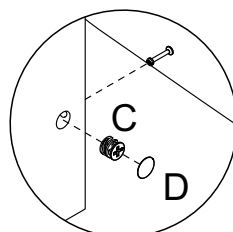
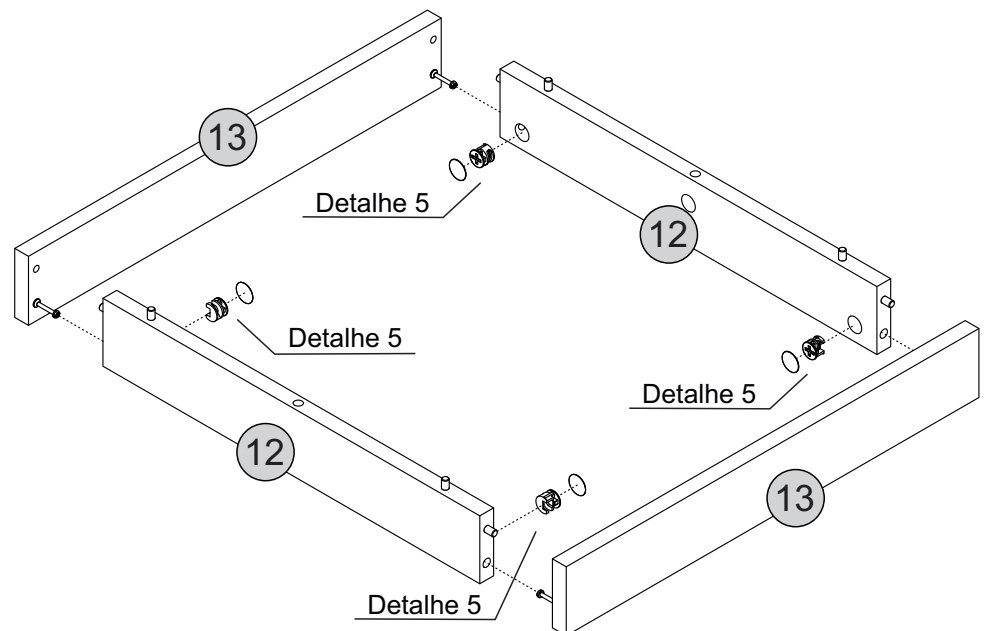
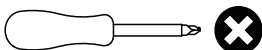

Detalle 5
Detail/Detalle

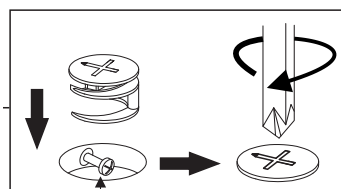

Cabeça do parafuso precisa estar no centro
La cabeza del tornillo debe estar en el centro
Screw head has to be in the center

Passo 15

Paso/Step

PEÇA
Piece/Pieza

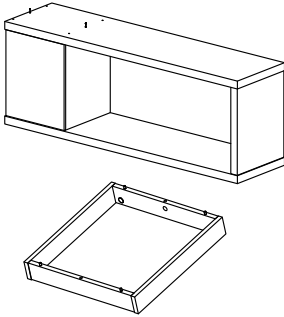

FERRAGEM
Hardware/Herraje

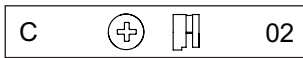

FERRAMENTA
Tool/Herramienta

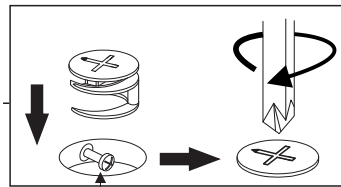
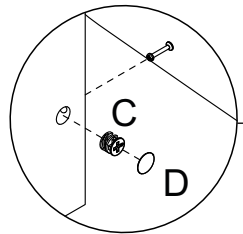
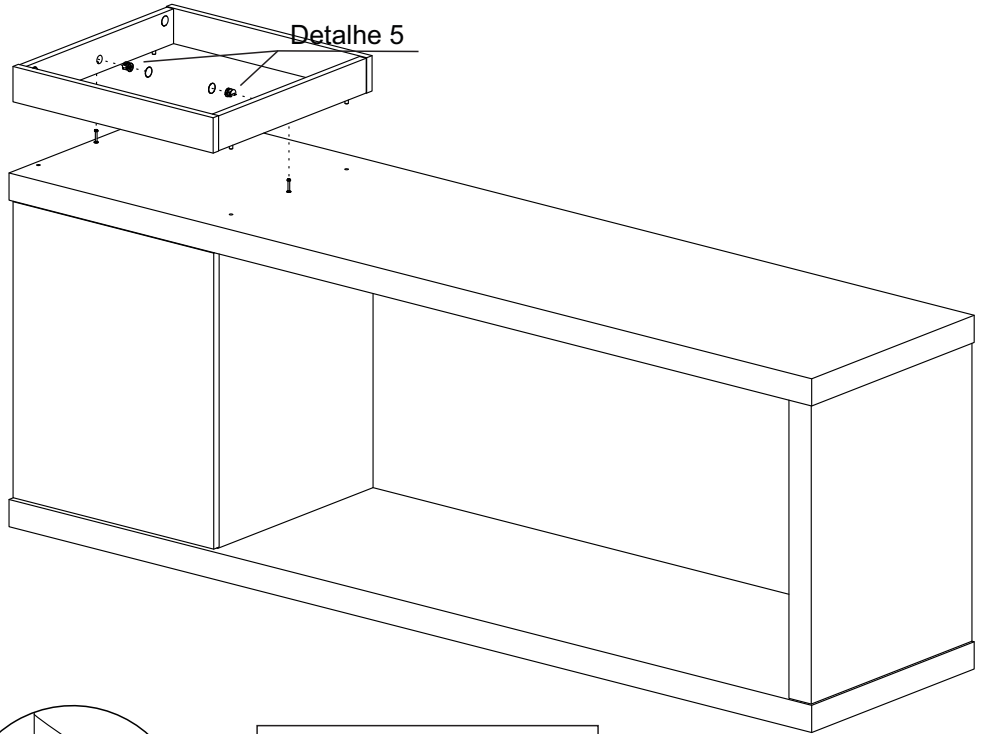
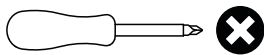

Detalhe 5
Detail/Detalle

Cabeça do parafuso precisa estar no centro
La cabeza del tornillo debe estar en el centro
Screw head has to be in the center

Passo 16

Paso/Step

PEÇA
Piece/Pieza

14 - ESPELHO	x1
--------------	----

FERRAGEM
Hardware/Herraje

FERRAMENTA
Tool/Herramienta

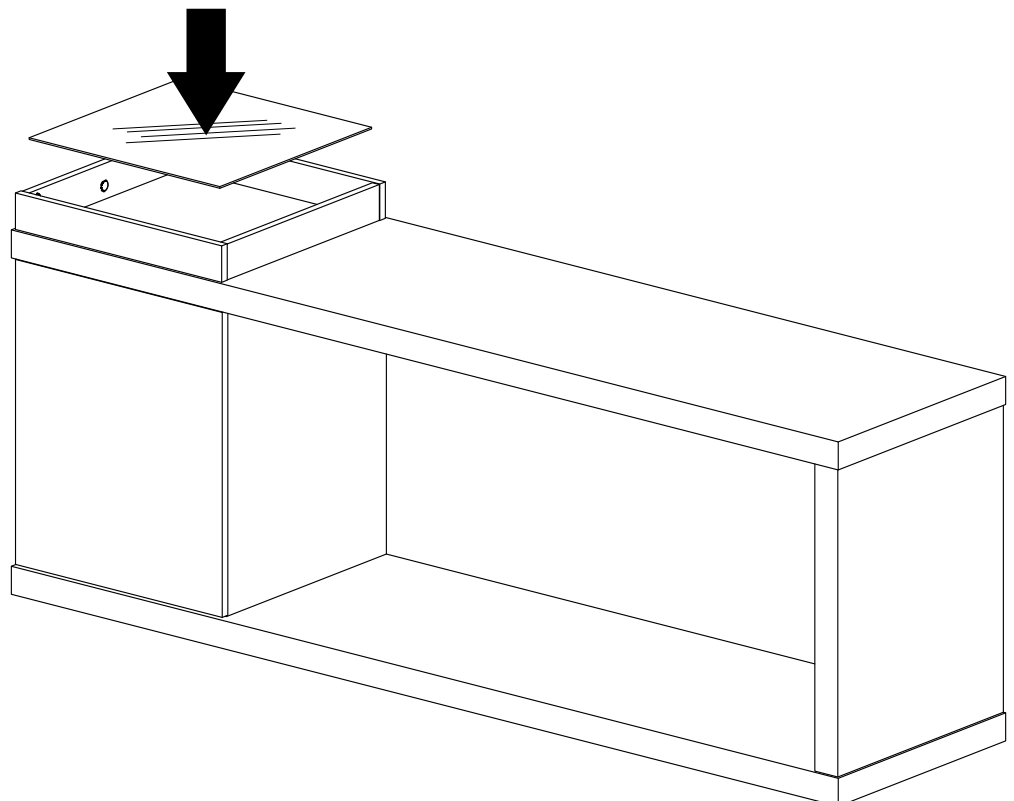

Passo 17

Paso/Step

PEÇA
Piece/Pieza

8 - TAMPO GARRAFEIRO x1

9 - BASE GARRAFEIRO x2

FERRAGEM
Hardware/Herraje

C   04

D  04

FERRAMENTA
Tool/Herramienta

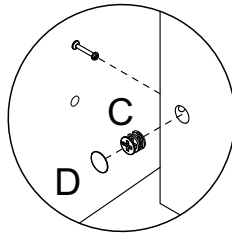
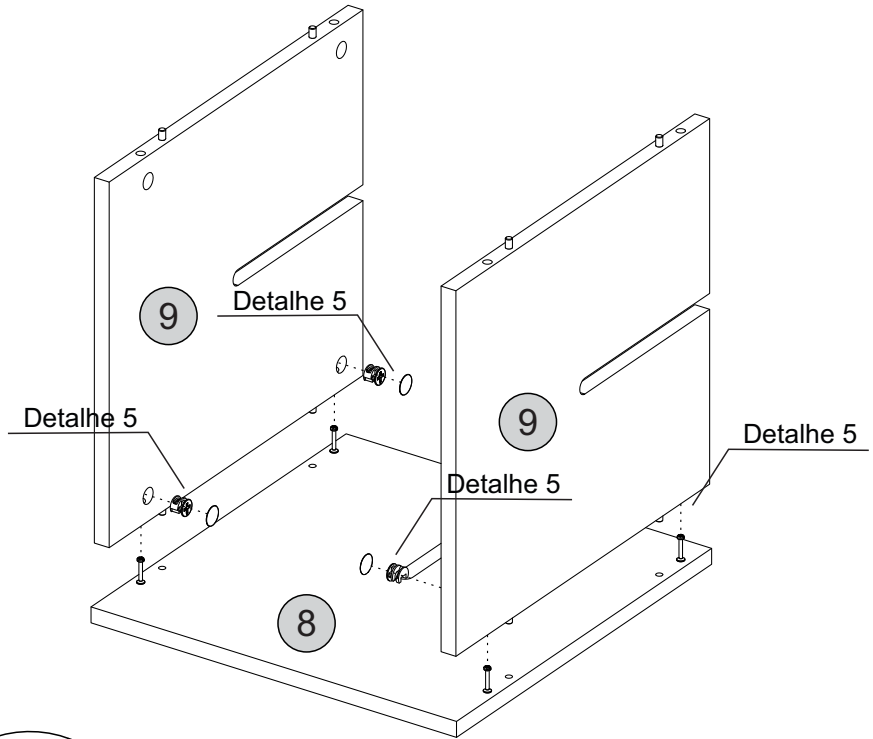
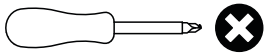

Detalhe 5
Detail/Detalle

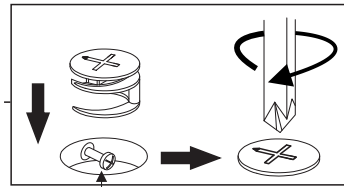

Cabeça do parafuso precisa estar no centro
La cabeza del tornillo debe estar en el centro
Screw head has to be in the center

Passo 18

Paso/Step

PEÇA
Piece/Pieza

8 - TAMPO GARRAFEIRO x1

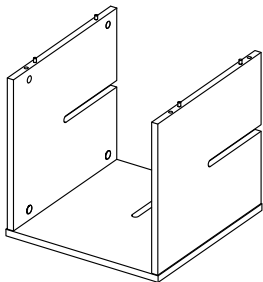

FERRAGEM
Hardware/Herraje

C   04

D  04

FERRAMENTA
Tool/Herramienta

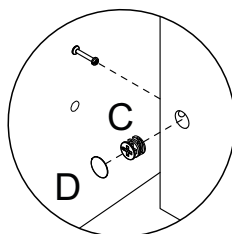
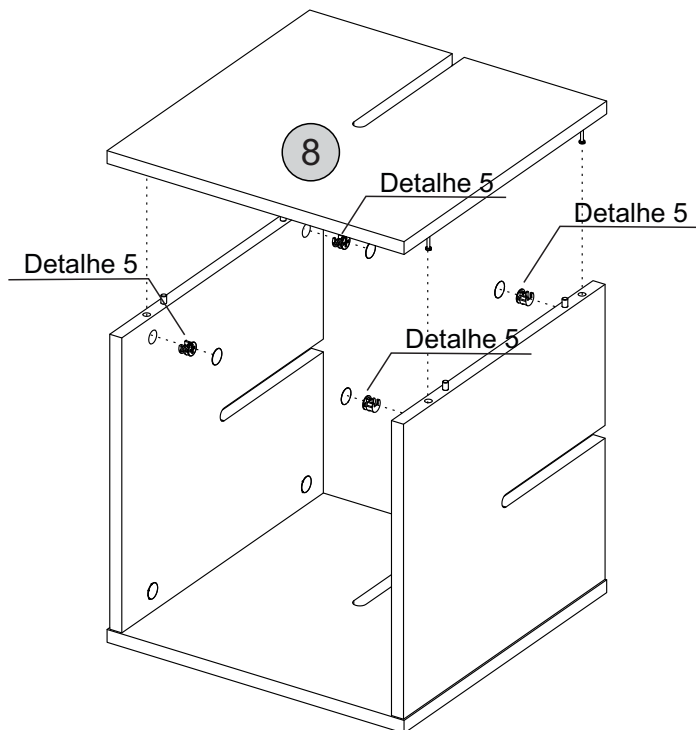
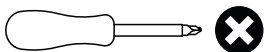

Detalhe 5
Detail/Detalle

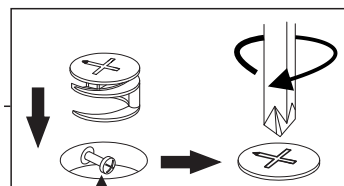

Cabeça do parafuso precisa estar no centro
La cabeza del tornillo debe estar en el centro
Screw head has to be in the center

Passo 19

Paso/Step

PEÇA
Piece/Pieza

6 - DIVISÃO ESQ. GAVET. x1

7 - DIVISÃO DIR. GAVET. x1

FERRAGEM
Hardware/Herraje

FERRAMENTA
Tool/Herramienta

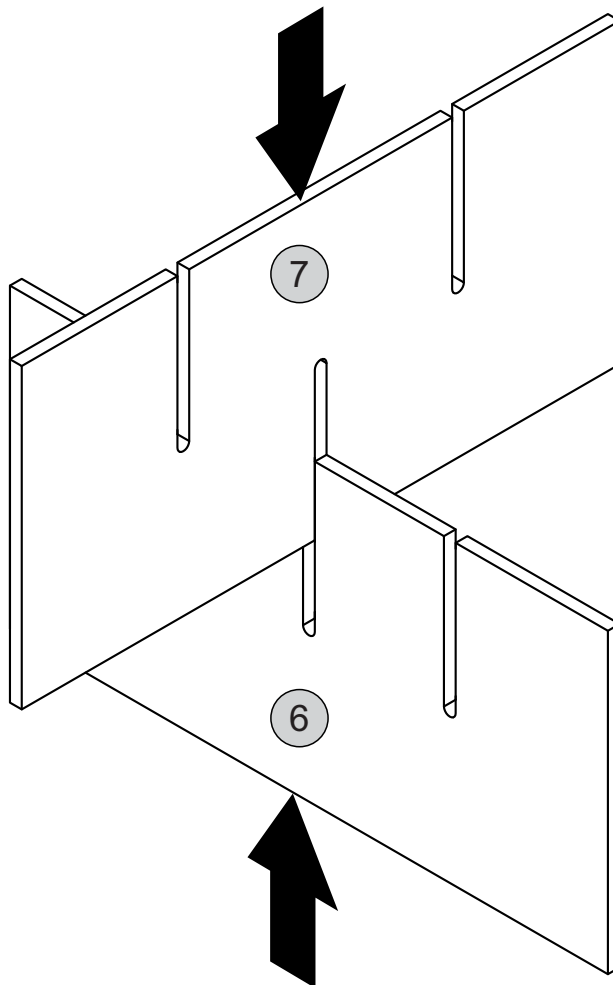

Passo 20

Paso/Step

PEÇA
Piece/Pieza

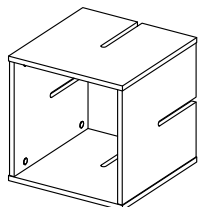
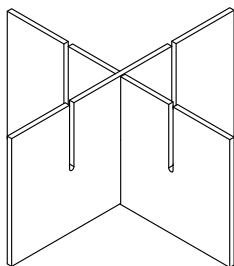

FERRAGEM
Hardware/Herraje

FERRAMENTA
Tool/Herramienta

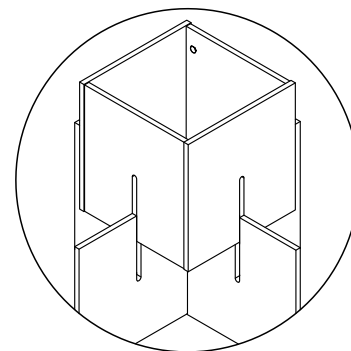
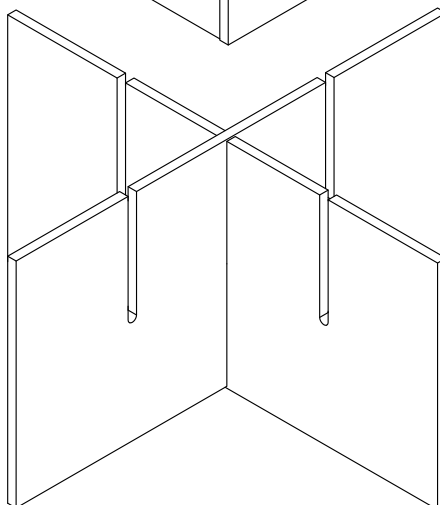
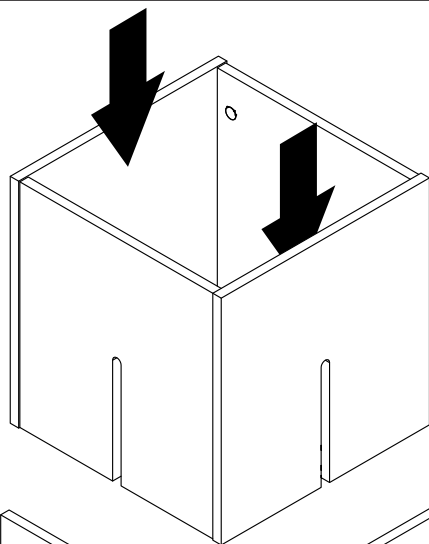

Detalhe 8
Detail/Detalle

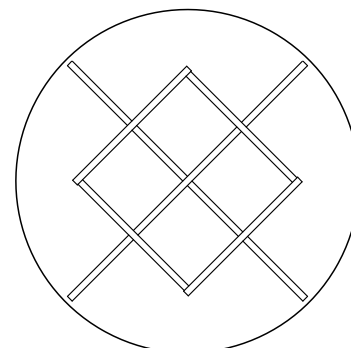

Detalhe 9
Detail/Detalle

Passo 21

Paso/Step

PEÇA
Piece/Pieza

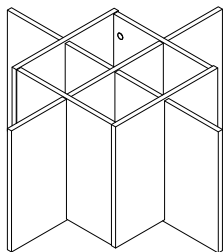

FERRAGEM
Hardware/Herraje

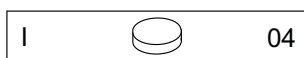

FERRAMENTA
Tool/Herramienta

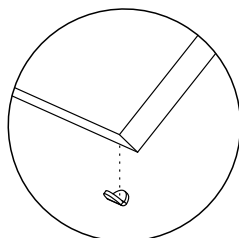
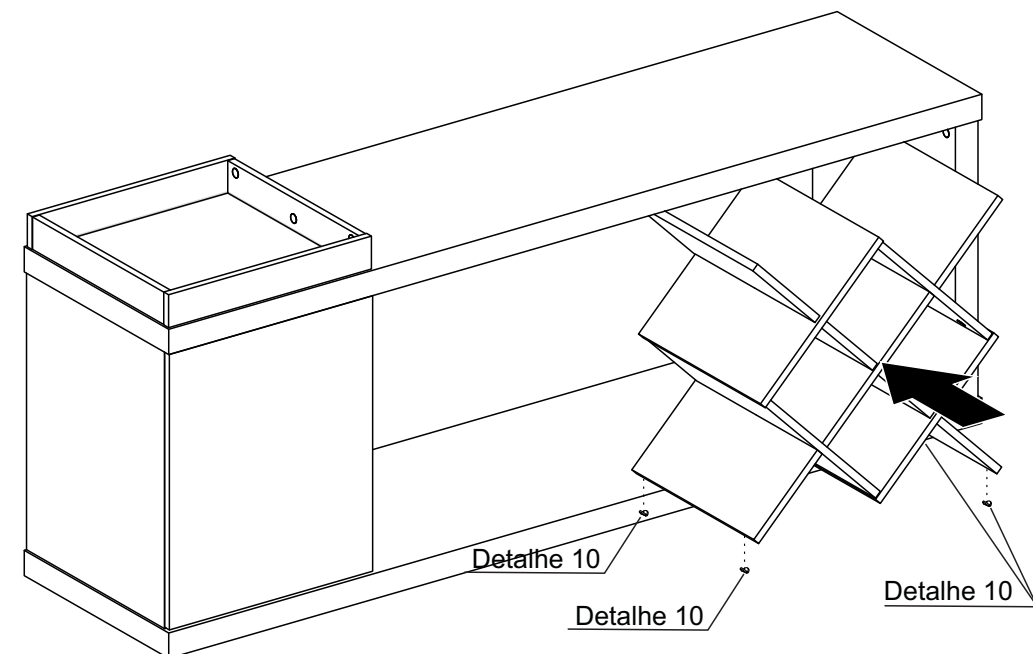

Detalhe 10
Detail/Detalle



Parabéns, você montou seu móvel! Agora é só decorar sua casa e aproveitar!

Queremos ver como ficou o móvel Artely do seu jeito... Marque a gente com a #meuartely. Ficaremos felizes em compartilhar!

Ah, e se tiver qualquer dúvida, sugestão ou comentário, entra em contato com a gente pelo nosso site www.artely.com.br.

¡Congratulaciones, montaste tu mueble! ¡Ahora solo decora tu casa y disfruta!

Queremos ver este producto en tu hogar, a tu manera... Utilice #meuartely, ¡ficaremos encantados de compartir tu foto!

Si tienes alguna duda, sugerencia o comentario, contáctenos a través de nuestro sitio web www.artely.com.br.

Congratulations, you've assembled your new furniture! Decorate your home and enjoy!

We want to see how this product is in your home... Use #meuartely, we will be happy to share your picture!



If you have any doubt, suggestion or comment, get in touch with us through our website www.artely.com.br.