



JCM
movelaria

Rack Sereno Sereno TV Stand Mesa de TV Sereno



ENCONTRE UM MONTADOR
FAÇA SEU ORÇAMENTO

▶ BAIXE O APP

Cupom: JCM30







Indicamos que a montagem dos produtos seja realizada com parafusadeira eléctrica e por um montador profissional.
We recommend that a professional furniture assembler assemble the product by using a cordless screwdriver.
Se recomienda que un montador de muebles profesional realice el montaje del producto con un destornillador eléctrico.

AVISO: Não nos comprometemos pelo mal-uso, montagem e fixação do produto à parede. Portanto, não somos responsáveis por danos e quedas do produto, eletrônicos e pertences neles contidos. É importante o uso de brocas e ferramentas compatíveis na montagem.
NOTICE: The company is not responsible for the misuse, assembly, and wall fixation, as well as the damages and falls that the products, electronics, and belongings therein might suffer. It is important to use suitable drills and tools to assemble the product.
ATENCIÓN: La empresa no se responsabiliza del mal uso, montaje y fijación del producto a la pared, así como de daños y caídas del producto, electrónicos u objetos. Es importante el uso de taladros y herramientas compatibles con el montaje.

Dica: para evitar possíveis avarias, use a embalagem do produto como apoio durante a montagem.
Tip: to avoid damages, use the product packaging as a base during the assembly.
Pista: para evitar daños, use el envase del producto como apoyo durante el montaje.

RELAÇÃO DE FERRAGENS | HARDWARE LIST | LISTADO DE HERRAJES

CONEXÃO ANGULAR	(A)	CORNER JOINT	(A)	SOPORTE ANGULAR	(A)		07
KIT ROLDANA E GUIA PLÁSTICO	(B)	ROLLER AND PLASTIC GUIDE	(B)	RODILLO Y GUÍA DE PLÁSTICO	(B)		01
PARAFUSO 3,5x14	(C)	3.5x14 SCREW	(C)	TORNILLO 3,5x14	(C)		08
PARAFUSO 4x25	(D)	4.0x25 SCREW	(D)	TORNILLO 4,0x25	(D)		18
PARAFUSO 3,5x14 FLANG.	(E)	3.5x14 FLANGE SCREW	(E)	TORNILLO TIPO FLANGE 3,5x14	(E)		28
PARAFUSO 5x40	(F)	5x40 SCREW	(F)	TORNILLO 5x40	(F)		12
PARAFUSO MINIFIX	(G)	MINIFIX BOLT	(G)	PERNO MINIFIX	(G)		08
PREGO 8x8 C/C	(H)	8x8 NAIL	(H)	CLAVO 8x8	(H)		30
PINO SUPORTE PRATELEIRA	(I)	SHELF SUPPORT	(I)	SOPORTE DE REPISA	(I)		08
SAPATA DESLIZANTE	(J)	GLIDE	(J)	PATÍN	(J)		04
TAMBOR MINIFIX	(K)	MINIFIX CAM	(K)	CAJA DEL MINIFIX	(K)		08

RELAÇÃO DE PEÇAS | PARTS LIST | LISTADO DE PARTES

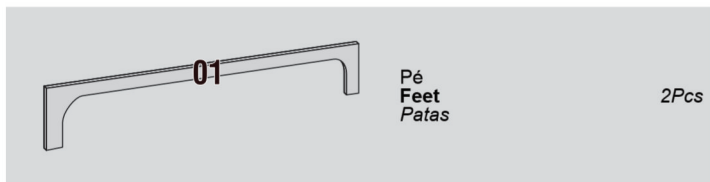
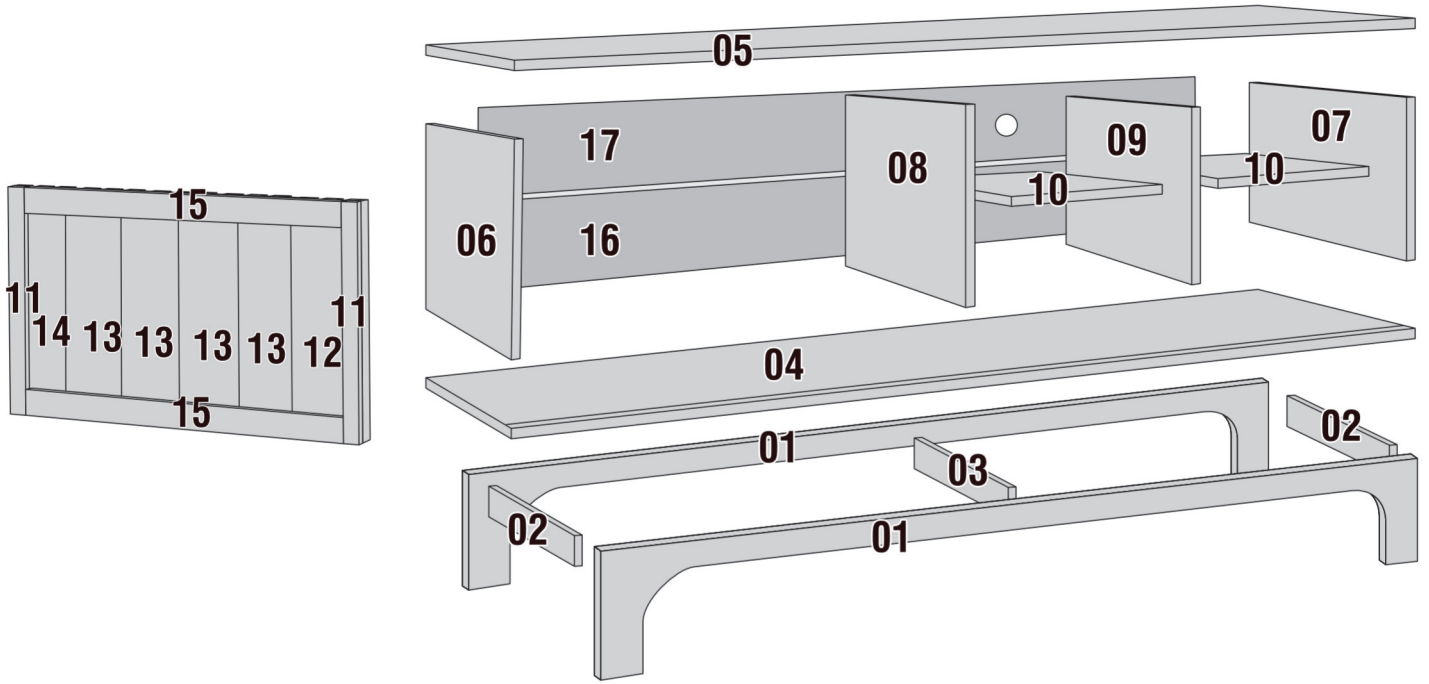

01 Pé Feet Patas 2Pcs



02 Rodapé Lateral Side Toe Zócalo Lateral 2Pcs

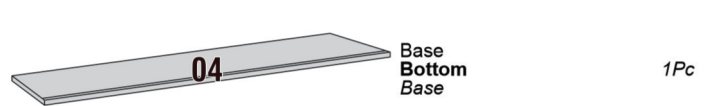

03 Rodapé Interno Internal Toe Zócalo Interno 1Pc

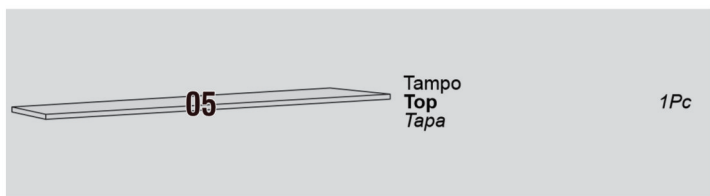

04 Base Bottom Base 1Pc



05 Tampo Top Tapa 1Pc



06 Lateral Esquerda Left Side Lateral Izquierdo 1Pc



07 Lateral Direita Right Side Lateral Derecho 1Pc



08 Divisão Esquerda Left Divider División Izquierda 1Pc



09 Divisão Direita Right Divider División Derecha 1Pc



10 Prateleira Shelf Repisa 2Pcs



11 Moldura Inf. e Sup. Porta Top/Bottom Rail Marco Superior/Inferior de la Puerta 2Pcs



12 Moldura Lateral Porta Stile Marco Lateral de la Puerta 2Pcs



13 Régua Porta Fêmea Sem Rasgo Slotless Female Dorr Panel Pnel de Puerta Hembra sin Ranura 1Pc



14 Régua Porta Macho e Fêmea com Rasgo Slotted Male/Female Dorr Panel Panel de Puerta Macho y Hembra com Ranura 4Pcs



15 Régua Porta Fêmea Sem Rasgo Slotless Female Dorr Panel Pnel de Puerta Hembra sin Ranura 1Pc



16 Costas Back Trasera 1Pc

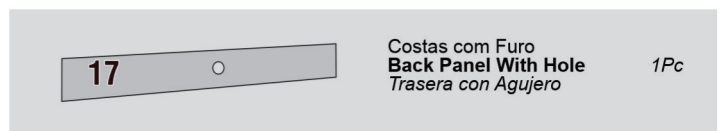

17 Costas com Furo Back Panel With Hole Trasera con Agujero 1Pc

Passo 01 INICIE A MONTAGEM PELA PEÇA 05 ENCAIXANDO AS PEÇAS 6, 7, 8 E 9 COM MINIFIX (G+K).
Step 01 START THE ASSEMBLY FROM PART 05. FASTEN PARTS 6, 7, 8 AND 9 WITH MINIFIX (G+K).
 Paso 01 EMPIECE EL ARMADO POR LA PARTE 05. FIJE LAS PARTES 6, 7, 8 Y 9 CON MINIFIX (G+K).

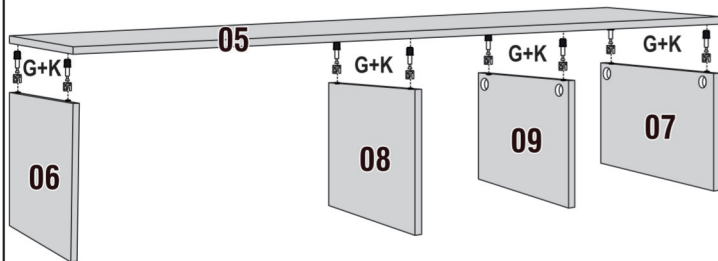

Passo 02 PARAFUSE A PEÇA 4 NAS PEÇAS 6, 7, 8 E 9 COM PARAFUSO 5x40 (F).
Step 02 FASTEN PART 4 TO PARTS 6, 7, 8 AND 9 WITH 5x40 SCREWS (F).
 Paso 02 FIJE LA PARTE 4 A LAS PARTES 6, 7, 8 Y 9 CON TORNILLOS 5x40 (F).

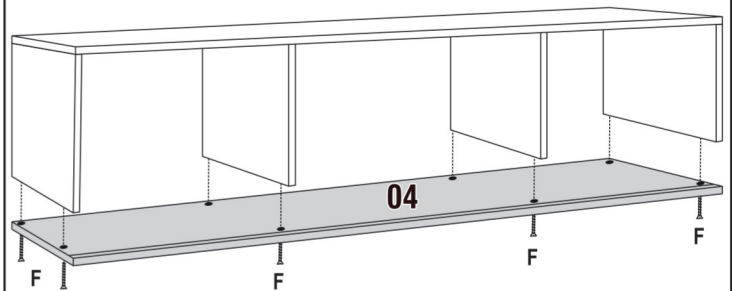

Passo 03 PARAFUSE AS PEÇAS 2 COM PARAFUSO 5x40 (F), PARAFUSE A PEÇA 3 COM 1 SUPORTE ANGULAR (A+E) NO CENTRO DA MESMA.
Step 03 FASTEN PARTS 2 WITH 5x40 SCREWS (F). FASTEN PART 3 WITH A CORNER JOINT (A+E) IN THE MIDDLE OF PART 4
 Paso 03 FIJE LAS PARTES 2 CON TORNILLOS 5x40 (F). FIJE LA PARTE 3 AL CENTRO CON EL SOPORTE ANGULAR (A+E).

VISTA INFERIOR
BOTTOM VIEW
 VISTA DESDE ABAJO

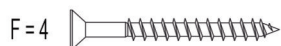
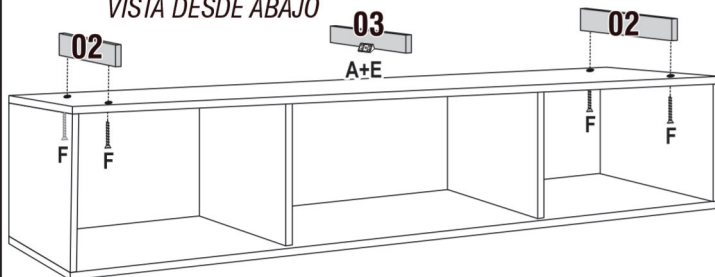

Passo 04 PARAFUSE OS PÉS 1 NAS PEÇAS 2 E 3 COM SUPORTE ANGULAR (A+E) E PARAFUSE AS SAPATAS (J+C), CONFORME DESENHO.
Step 04 FASTEN THE FEET (1) TO PARTS 2 AND 3 WITH CORNER JOINTS (A+E). FASTEN THE GLIDES (J+C), ACCORDING TO THE DRAWING.
 Paso 04 FIJE LAS PATAS (1) A LAS PARTES 2 Y 3 CON SOPORTE ANGULAR (A+E). FIJE LOS PATINES (J+C), SEGÚN EL DIBUJO.

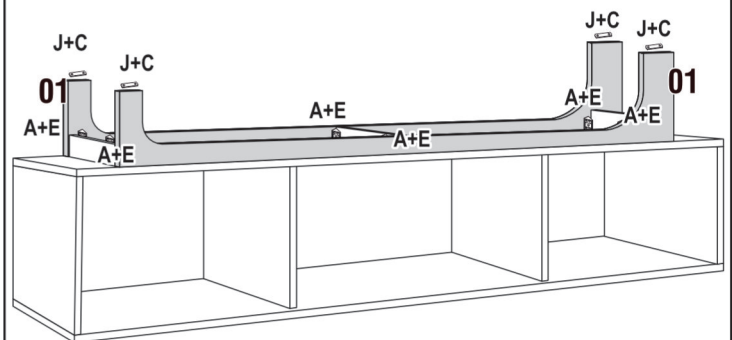

VISTA INFERIOR | **BOTTOM VIEW** | VISTA DESDE ABAJO

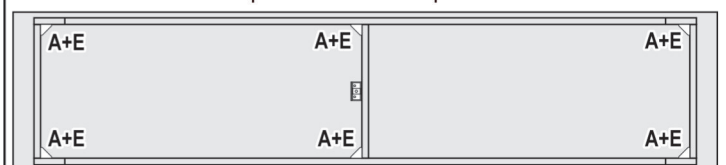

Passo 05 PREGUE AS COSTAS COM PREGO 8x8 (H).

Step 05 NAIL THE BACK WITH 8x8 NAILS (H).

Paso 05 CLAVE LA TRASERA CON CLAVOS 8x8 (H).

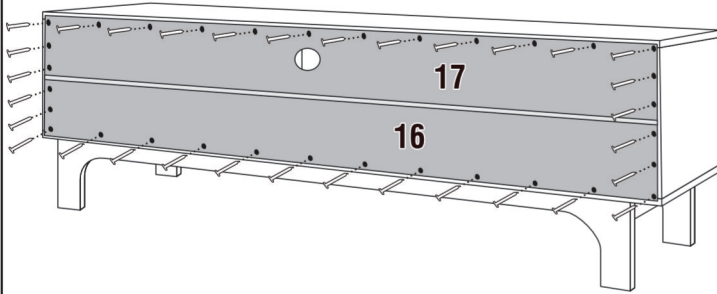



H = 30 

Passo 06 ENCAIXE A PEÇA 10 COM PINO SUPORTE (I).

Step 06 FASTEN PART 10 WITH SHELF SUPPORTS (I).

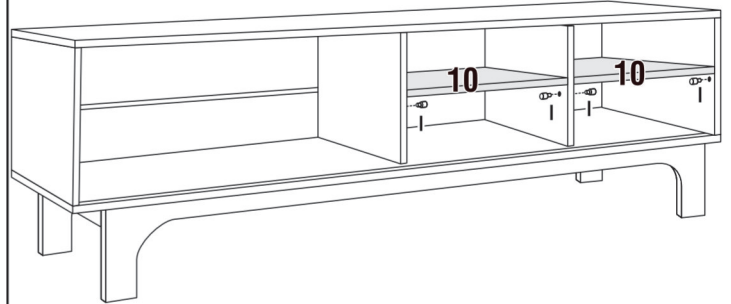
Paso 06 ENCAJE LA PARTE 10 CON SOPORTES DE REPISA (I).



I = 08 

Passo 07 MONTE AS PORTAS ENCAIXANDO AS PEÇAS 12, 13 E 14. APÓS ISSO, PARAFUSE AS PEÇAS 11 E 15 COM PARAFUSO 4x25 (D), PARAFUSE O KIT ROLDANA (B).

Step 07 ASSEMBLE THE DOORS BY FASTENING PARTS 12, 13, AND 14. AFTER THAT, ATTACH PARTS 11 AND 15 WITH 4x25 SCREWS (D). FASTEN THE ROLLERS AND THE PLASTIC GUIDE (B).

Paso 07 ARME LAS PUERTAS ENCAJANDO LAS PARTES 12, 13 Y 14. DESPUÉS, FIJE LAS PARTES 11 Y 15 CON TORNILLOS 4x25 (D). FIJE EL RODILLO Y LA GUÍA DE PLÁSTICO (B).

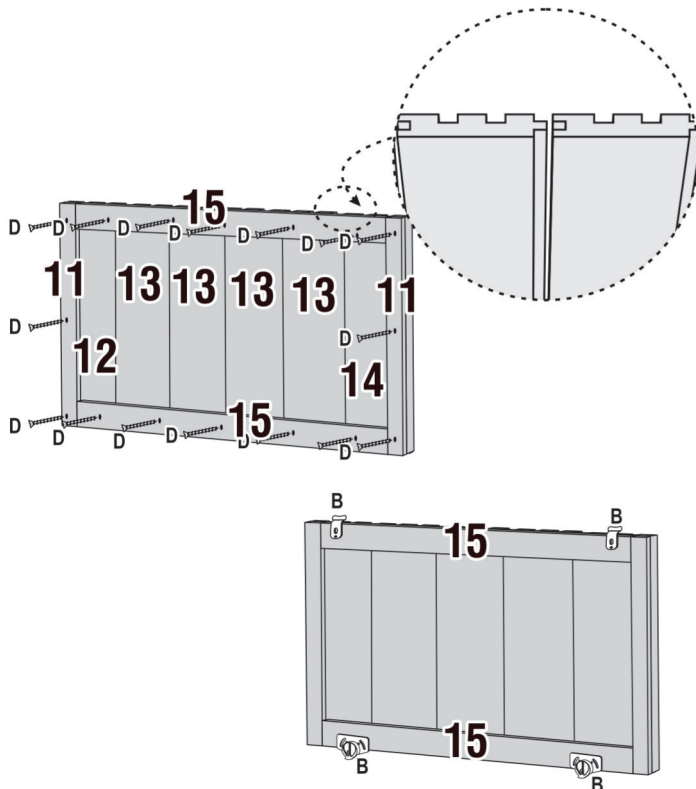

B = 1   

D = 18 

Passo 07 PRODUTO MONTADO.

Step 07 PRODUCT ASSEMBLED.

Paso 07 PRODUCTO ARMADO.

