

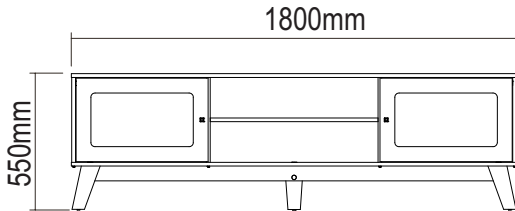

# Rack Charlotte

Rack Charlotte / Charlotte Rack

Versão 1.0 / Versión 1.0 / Version 1.0

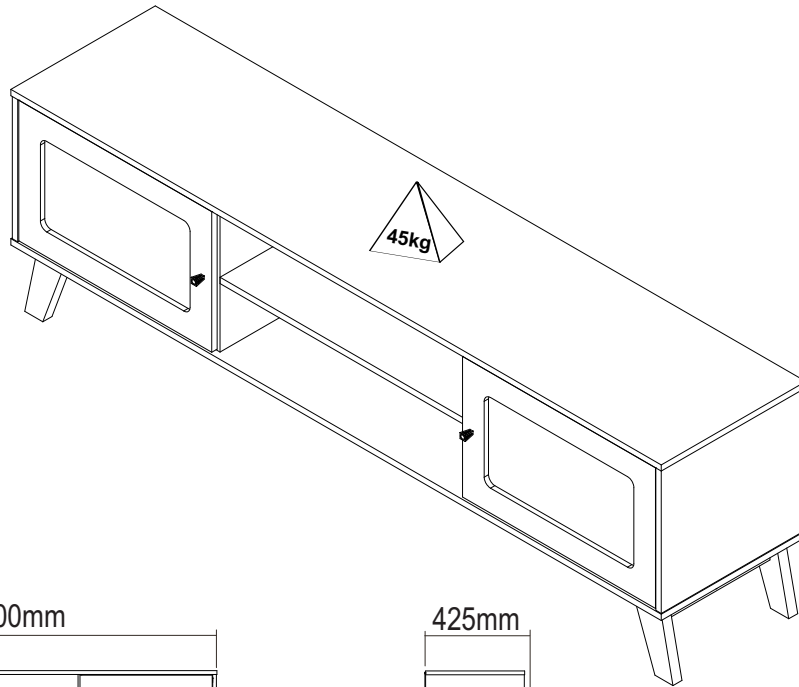

frente/frente/front

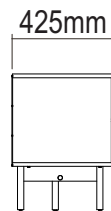

lateral/lado/side

## Conservação e Limpeza - Conservación y Limpieza - Conservation and Cleaning

**Não expor o produto ao sol, altas temperaturas e umidade. Não arrastar objetos sobre a superfície do móvel (ex.: TV, DVD, aparelho de som, objetos decorativos...) e manter em local seco e arejado. Para a limpeza, utilizar um pano seco e macio. Não é necessário o uso de materiais abrasivos ou álcool.**

*No exponga el producto a la luz solar, las altas temperaturas y la humedad. No arrastre los objetos a través de la superficie de la unidad (por ejemplo, TV, DVD, equipo de música, objetos de decoración ...) Mantener en un lugar fresco y seco. Para la limpieza, utilizar un paño seco y suave. El uso de materiales abrasivos o del alcohol no es necesario.*

*Do not expose the product to sunlight, high temperatures and humidity. Do not drag objects across the surface of the unit (TV, DVD, stereo, decorative objects ...) keep it in a cool dry place. For cleaning, use a dry and soft cloth. Do not use abrasive materials or alcohol.*

### Garantia

*Este certificado de Garantia é uma vantagem adicional oferecida ao consumidor, porém para que o mesmo tenha validade é imprescindível que seja apresentada a NOTA FISCAL de compra do produto.*

*Com este produto, a Artely tem como objetivo atender plenamente o proprietário-consumidor, proporcionando a garantia na forma aqui estabelecida, pelo período de três meses a partir da data da nota fiscal de compra. A Artely restringe a sua responsabilidade à substituição gratuita das peças defeituosas, em caso de defeitos ou avarias devidamente constatados como sendo de fabricação, durante a vigência desta garantia.*

*A Artely declara a garantia nula e sem efeito se o produto for alterado, adulterado, molhado ou consertado e ainda pela prática de montagem inadequada ou mau uso. Também será considerada nula em casos de força maior, como aqueles causados por agentes da Natureza (chuvas, incêndios, excesso de umidade, cupins,...) e eventos externos como objetos arrastados sobre a superfície do móvel (ex.: TV, DVD, aparelho de som, objetos decorativos...).*

*Para exercer seus direitos de comprador é importante que antes de montar seu produto você leia com atenção as instruções de cada passo do manual de montagem que acompanha o móvel.*

*Caso o produto não esteja em conformidade, entre em contato com a loja onde efetuou a compra e faça sua reclamação, apontando os defeitos técnicos observados. Para agilizar o seu atendimento, tenha sempre em mãos o manual de montagem com os respectivos números das peças defeituosas, conforme descritas no manual.*

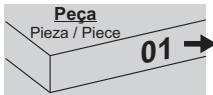



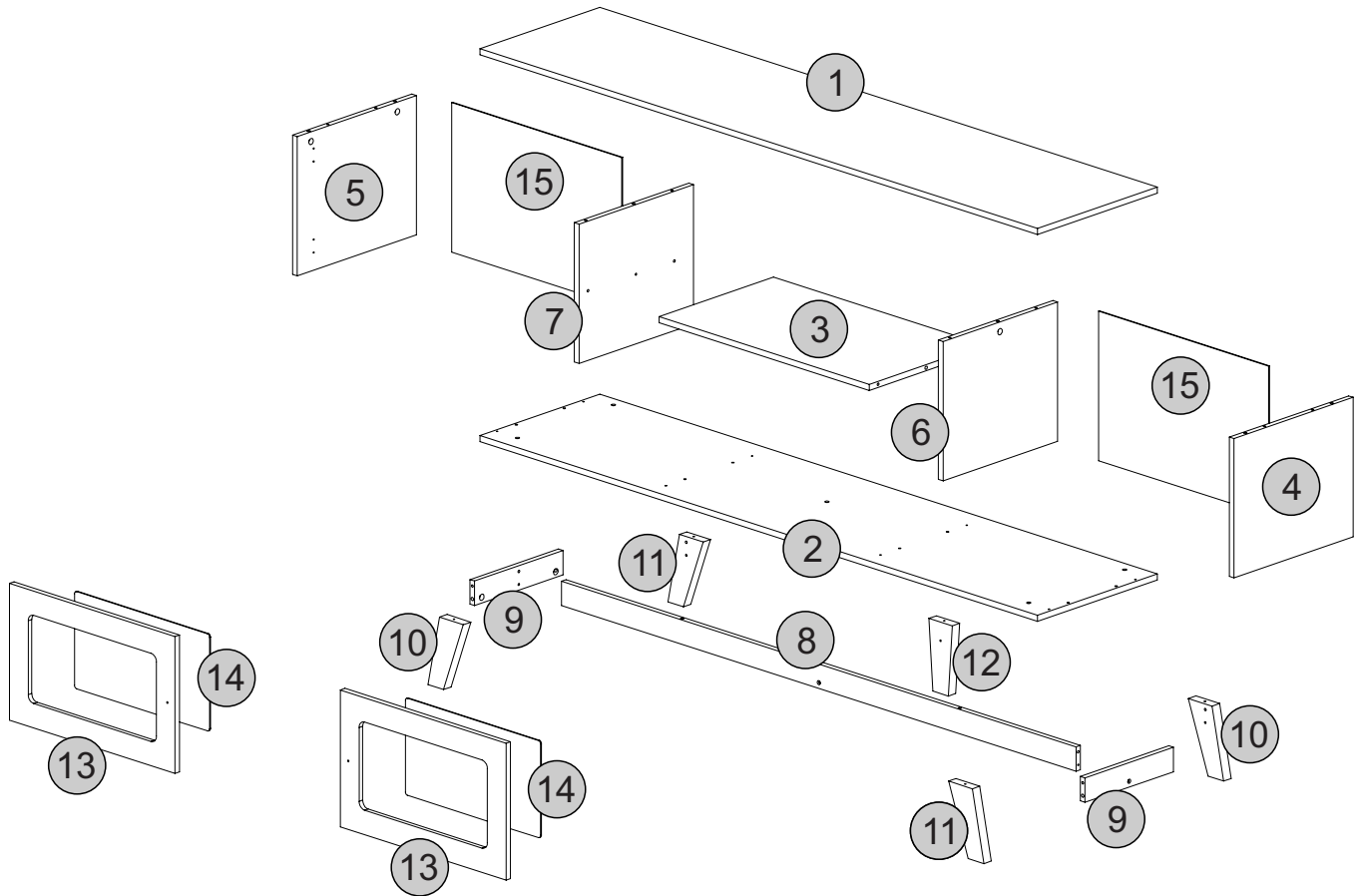
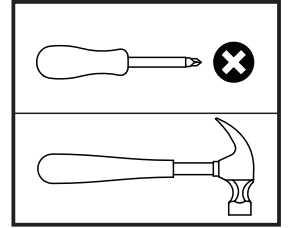





- O número na borda da peça corresponde ao manual.
- Para retirada do número usar Lustra-Móveis, Alcool em Gel ou Borracha.
- El número en el borde de la pieza coincide con el manual.
- Use una goma de borrar blanca, alcohol en gel o lustrador para muebles para eliminar los números.
- The number on the edge of the piece matches the manual.
- Use a White eraser, Alcohol Gel or Furniture Polish to remove the numbers.

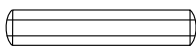
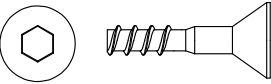
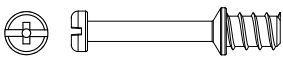
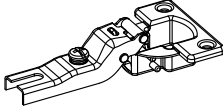
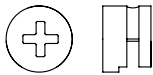
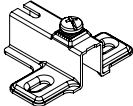

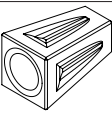
Descrição	Descripción	Description	Qty
1-Tampo (1800x400x15mm)	1-Tapa	1-Top	1
2-Base (1800x400x15mm)	2-Base	2-Base	1
3-Prateleira Fixa (678x382x15mm)	3-Fixed Shelf	3-Estante Fijo	1
4-Lateral Esquerda (343x378x15mm)	4-Lado izquierdo	4-Left side	1
5-Lateral Direita (343x378x15mm)	5-Lado derecho	5-Right side	1
6-Divisão Direita (343x398x15mm)	6-División derecho	6-Right Division	1
7-Divisão Esquerda (343x382x15mm)	7-División izquierdo	7-Left Division	1
8-Travessa Inferior (1660x60x15)	8-Bottom Crossbar	8-Travesaño inferior	1
9-Travessa dos Pés (295x60x15mm)	9-Foot Rail	9-Riel de Pie	2
10-Pé Esquerdo (180x77x15mm)	10-Left Foot	10-Pie Izquierdo	2
11-Pé Direito (180x77x15mm)	11-Right Foot	11-Pie Derecho	2
12-Pé Central (180x75x15mm)	12-Center Foot	12-Pie central	1
13-Porta (534x337x15mm)	13-Door	13-Puerta	2
14-Almofada (436x239x3mm)	14-Pillow	14-Almohada	2
15-Traseiro (549x368x3mm)	15-Rear	15-Trasero	2

## Lista de Materiais

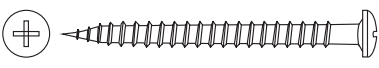
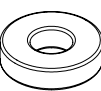
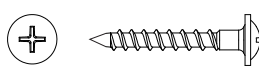
### Lista de Materiales/ Hardware List

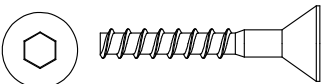
<b>A</b>		Cavilha / Tarugo / Dowel Ø6x30mm	<b>26</b>	<b>J</b>		Parafuso / Tornillo / Screw / Ø5,0x24mm cab 10	<b>01</b>
<b>B</b>		Minifix / Minifix / Minifix Ø7x30mm	<b>14</b>	<b>K</b>		Dobradiça / Bisagra / Hinge /	<b>04</b>
<b>C</b>		Tambor / Tambor / Minifix Cam Ø15x12mm	<b>14</b>	<b>L</b>		Calço Dobradiça/ Cuña de Bisagra / Hinge Shim /	<b>04</b>
<b>D</b>		Tapa furo adesivo / Adhesivo / Hole Cover Ø18mm	<b>20</b>	<b>M</b>		Puxador / Arrancador / Puller /	<b>02</b>
<b>E</b>		Parafuso Tornillo / Screw Ø4x14mm CP	<b>16</b>	<b>N</b>		Sapata Fixa / Pata Fija / Fixed Foot Ø5,0x10mm	<b>05</b>
<b>F</b>		Parafuso Tornillo / Screw Ø3,5x16mm CC	<b>20</b>	<b>O</b>		Prego / Clavo / Nail 8x8	<b>28</b>
<b>G</b>		Parafuso / Tornillo / Screw / Ø3,5x40mm CP	<b>08</b>	<b>P</b>		Aruela / Aruela / Washer / 12x3	<b>20</b>
<b>H</b>		Parafuso / Tornillo / Screw / Ø3,5x25mm CF	<b>02</b>	<b>Q</b>		Chave Zeta / Clave Zeta / Allen Key	<b>01</b>
<b>I</b>		Parafuso / Tornillo / Screw / Ø5,0x40mm cab 10	<b>07</b>				

### DICAS PARA FIXAR MINIFIX

TIP TO FASTEN THE MINIFIX  
PISTA PARA ARREGLAR EL MINIFIX

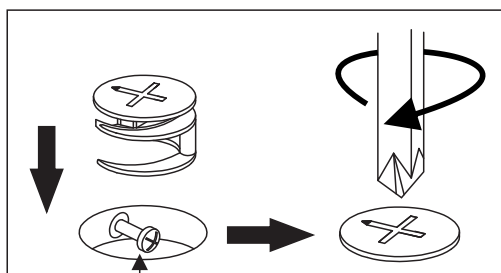

**Cabeça do parafuso precisa estar no centro**

La cabeza del tornillo debe estar en el centro  
Screw head has to be in the center

#### Parafuso Minifix

Tornillo minifix/Minifix screw

**Fixe o parafuso até o ressalto encostar na superfície da peça (veja o exemplo abaixo).**

Tighten the screw until its overhang part lean on the piece surface (see the example below).

Fije el tornillo hasta que su parte sobresaliente toque la superficie de la pieza (vea el ejemplo abajo).

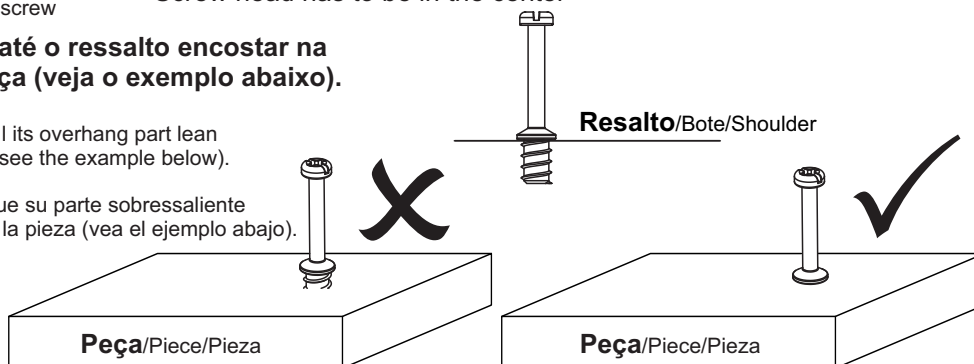

# Passo 1

Paso/Step

**PEÇA**  
Pieza/Piece

1 - TAMPO x1

**FERRAGEM**  
Herraje/Hardware

B  06

**FERRAMENTA**  
Herramienta/Tool

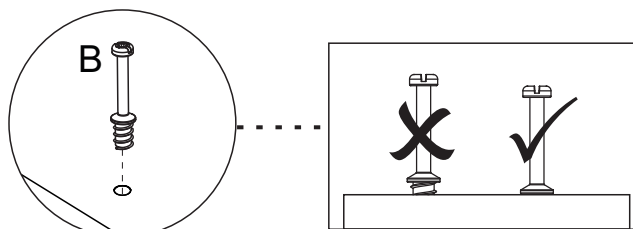
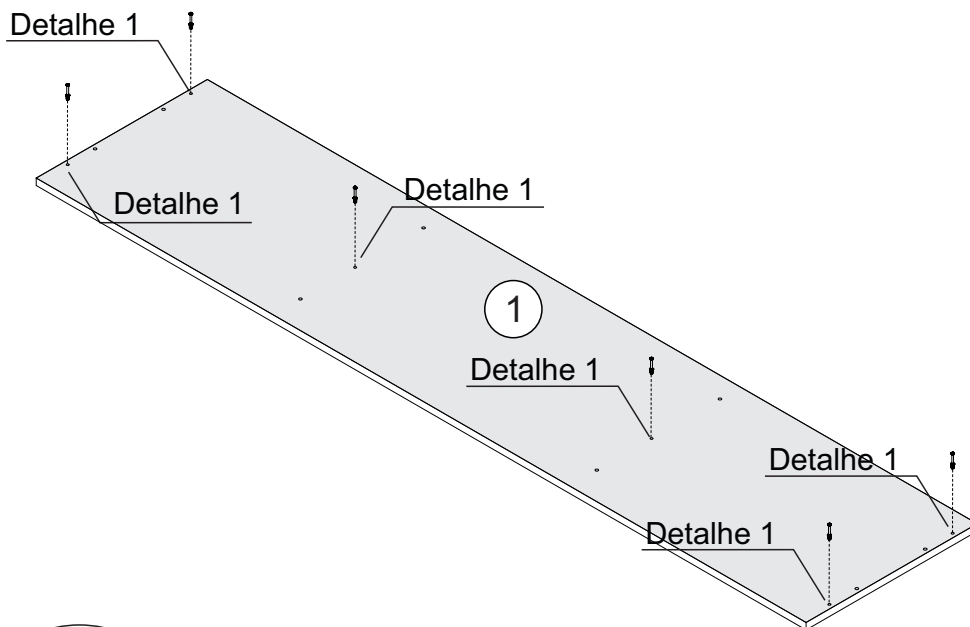
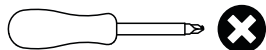

**Detalhe 1**  
Detalle/Detail

# Passo 2

Paso/Step

**PEÇA**  
Pieza/Piece

2 - BASE x1

**FERRAMENTA**  
Herramienta/Tool

B  02

**FERRAMENTA**  
Herramienta/Tool

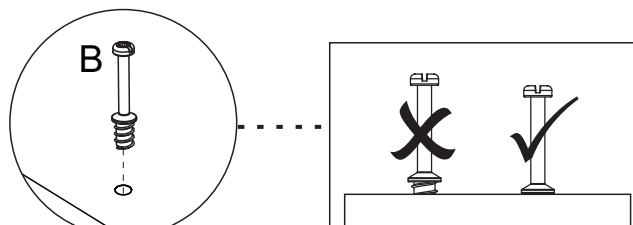
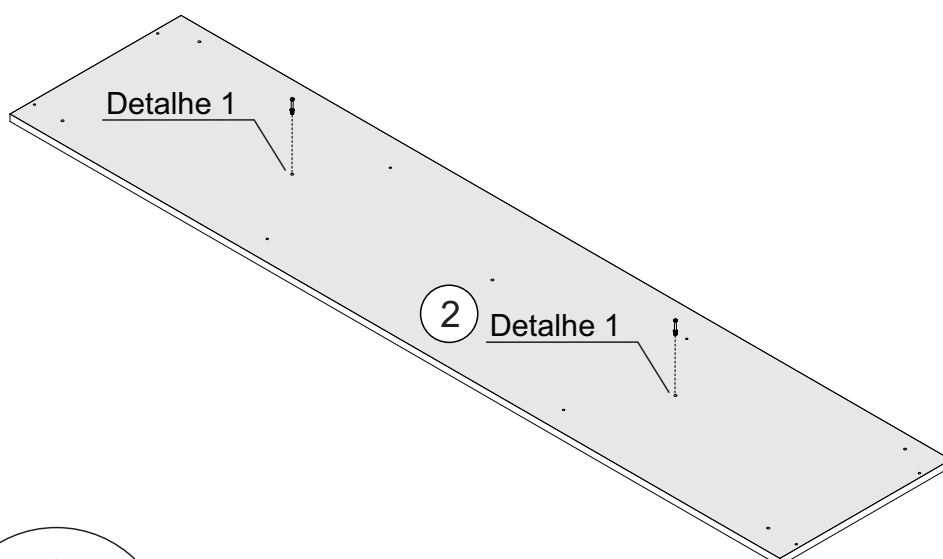
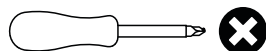

**Detalhe 1**  
Detalle/Detail

# Passo 3

Paso/Step

**PEÇA**  
Pieza/Piece

5 - LATERAL ESQUERDA x1

**FERRAGEM**  
Herraje/Hardware

A  04

E  04

L  02

**FERRAMENTA**  
Herramienta/Tool

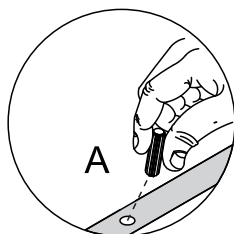
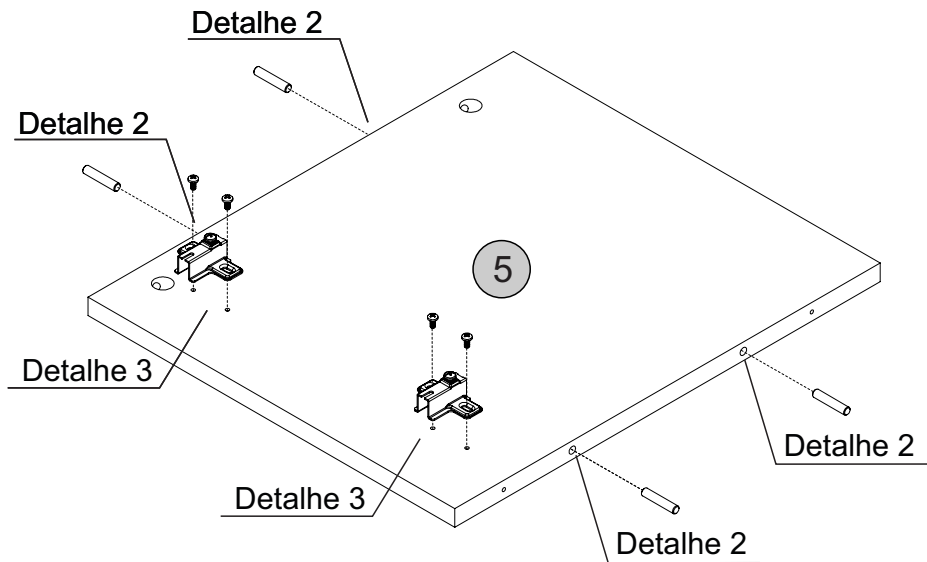
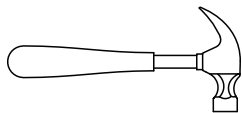
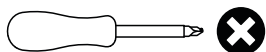

**Detalhe 2**  
Detalle/Detail

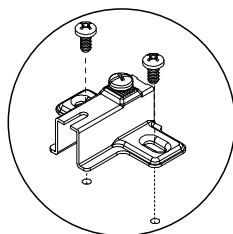

**Detalhe 3**  
Detalle/Detail

# Passo 4

Paso/Step

**PEÇA**  
Pieza/Piece

4 - LATERAL DIREITA x1

**FERRAGEM**  
Herraje/Hardware

A  04

E  04

L  02

**FERRAMENTA**  
Herramienta/Tool

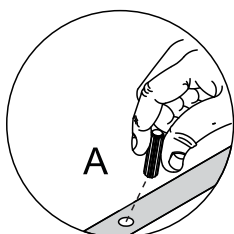
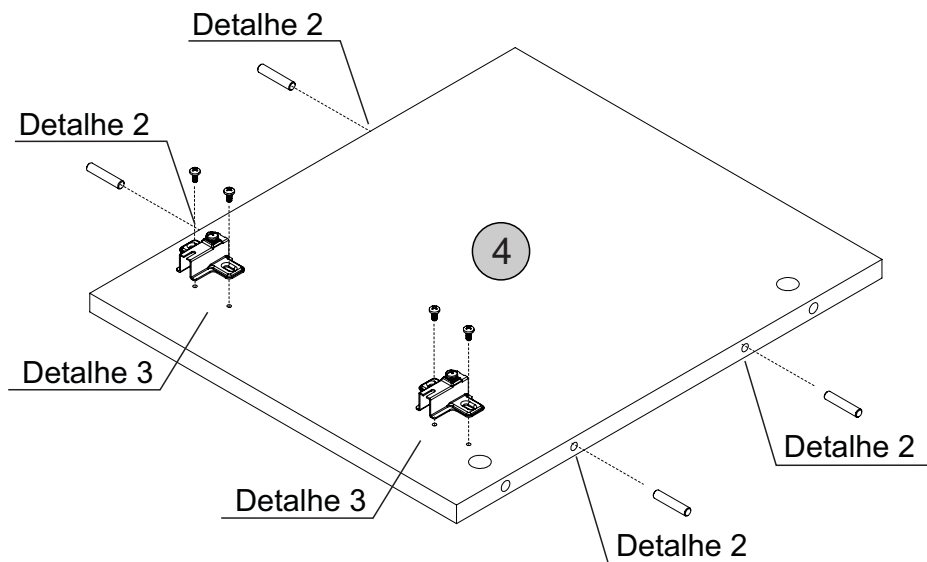
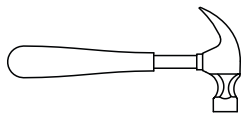
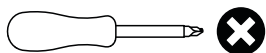

**Detalhe 2**  
Detalle/Detail

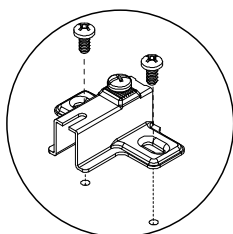

**Detalhe 3**  
Detalle/Detail

# Passo 5

Paso/Step

**PEÇA**  
Pieza/Piece

6 - DIVISÃO DIREITA x1

**FERRAGEM**  
Herraje/Hardware

A  04

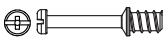
B  01

**FERRAMENTA**  
Herramienta/Tool

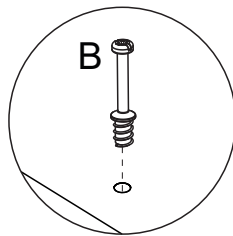
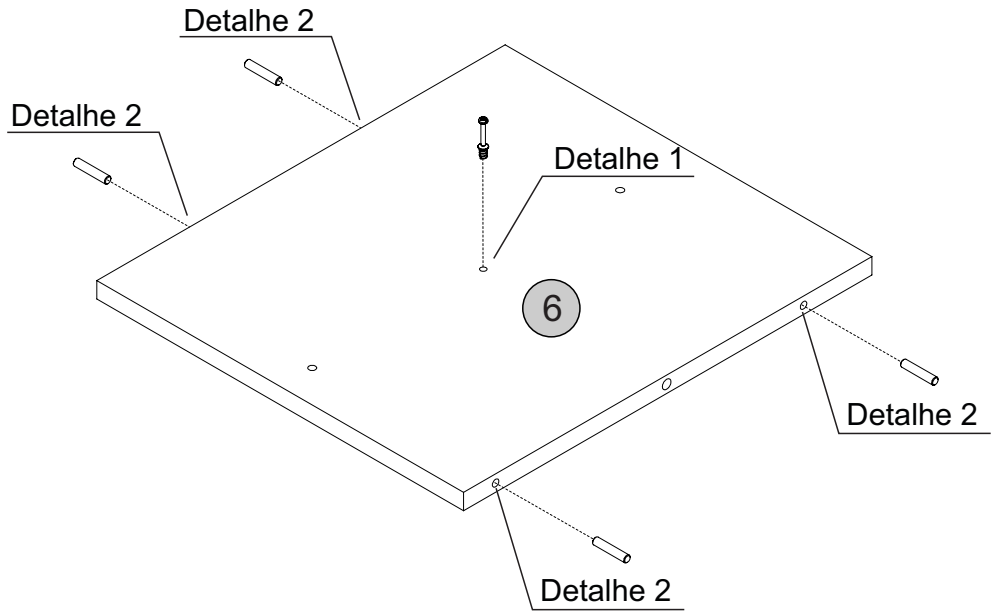
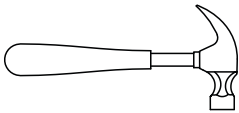
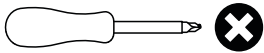

**Detalhe 1**  
Detalle/Detail

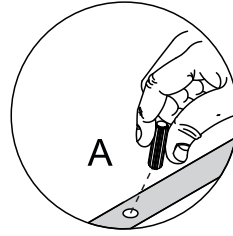
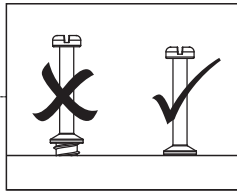

**Detalhe 2**  
Detail/Detaile

# Passo 6

Paso/Step

**PEÇA**  
Pieza/Piece

7 - DIVISÃO ESQUERDA x1

**FERRAGEM**  
Herraje/Hardware

A  04

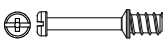
B  01

**FERRAMENTA**  
Herramienta/Tool

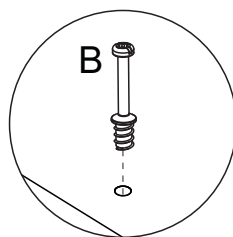
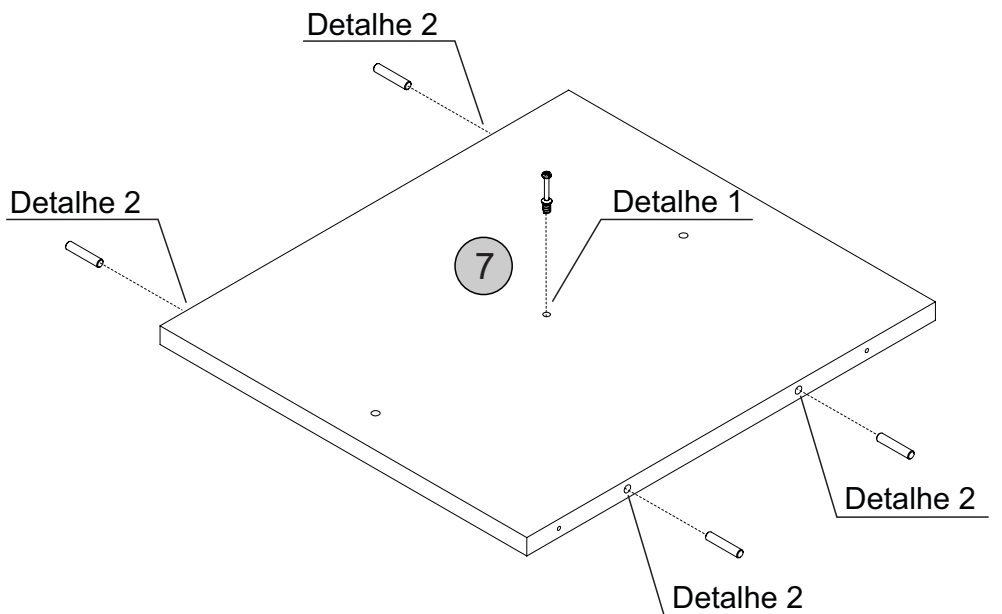
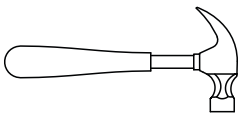
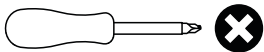

**Detalhe 1**  
Detalle/Detail

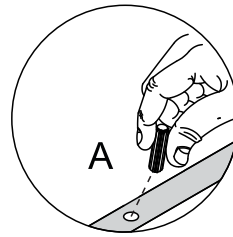
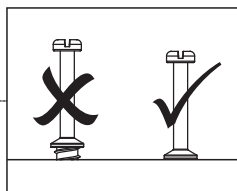

**Detalhe 2**  
Detail/Detaile

# Passo 7

Paso/Step

## PEÇA

Pieza/Piece

6 - PRATELEIRA x1

## FERRAGEM

Herraje/Hardware

A  04

## FERRAMENTA

Herramienta/Tool

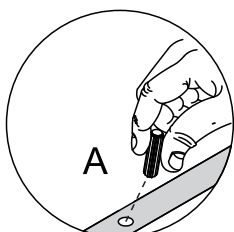
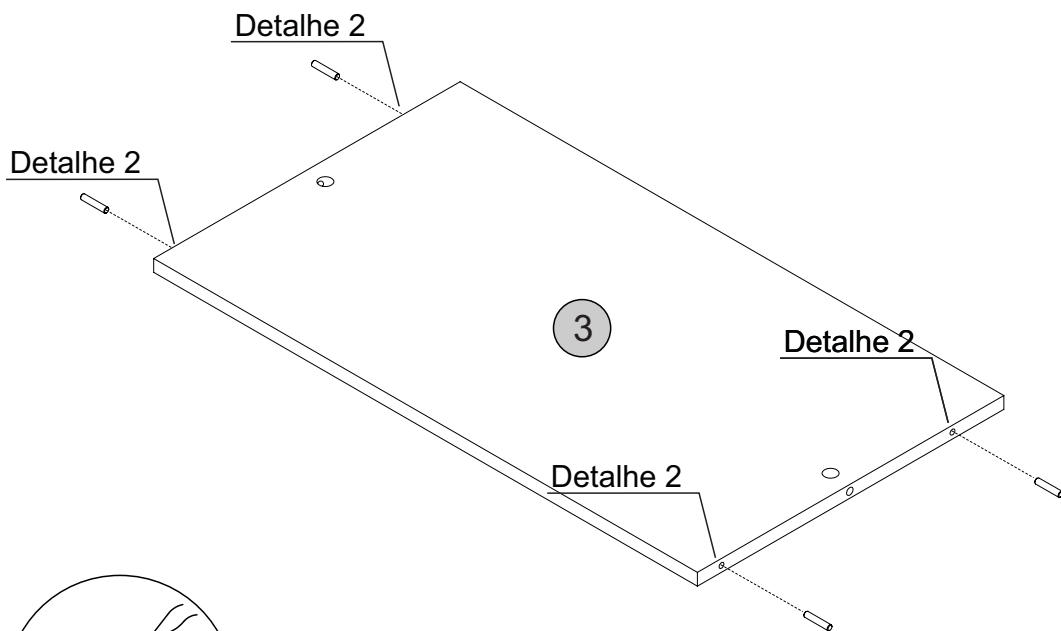
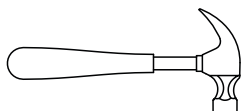

**Detalhe 2**  
Detail/Detaile

# Passo 8

Paso/Step

## PEÇA

Pieza/Piece

10 - PÉ ESQUERDO x2

11 - PÉ DIREITO x2

## FERRAGEM

Herraje/Hardware

B  04

N  04

## FERRAMENTA

Herramienta/Tool

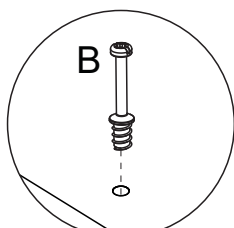
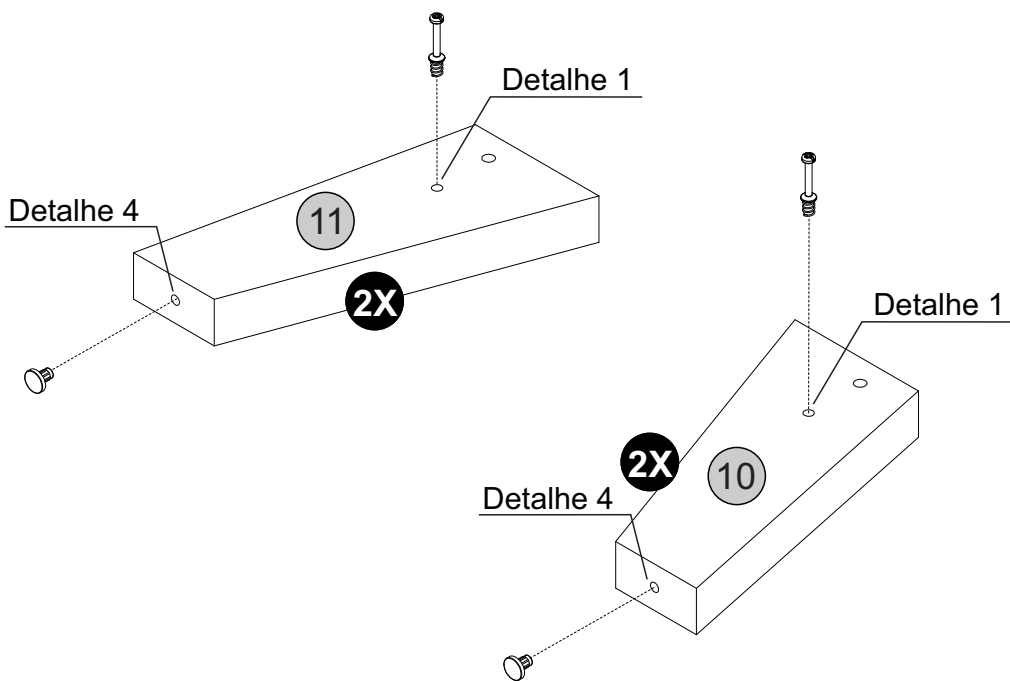
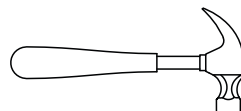
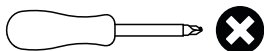

**Detalhe 1**  
Detalle/Detail

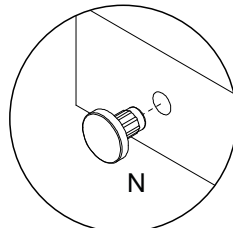
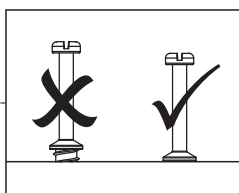

**Detalhe 4**  
Detalle/Detail

# Passo 9

Paso/Step

**PEÇA**  
Pieza/Piece

9 - TRAVESSA DOS PÉS x2

**FERRAGEM**  
Herraje/Hardware

A  04

**FERRAMENTA**  
Herramienta/Tool

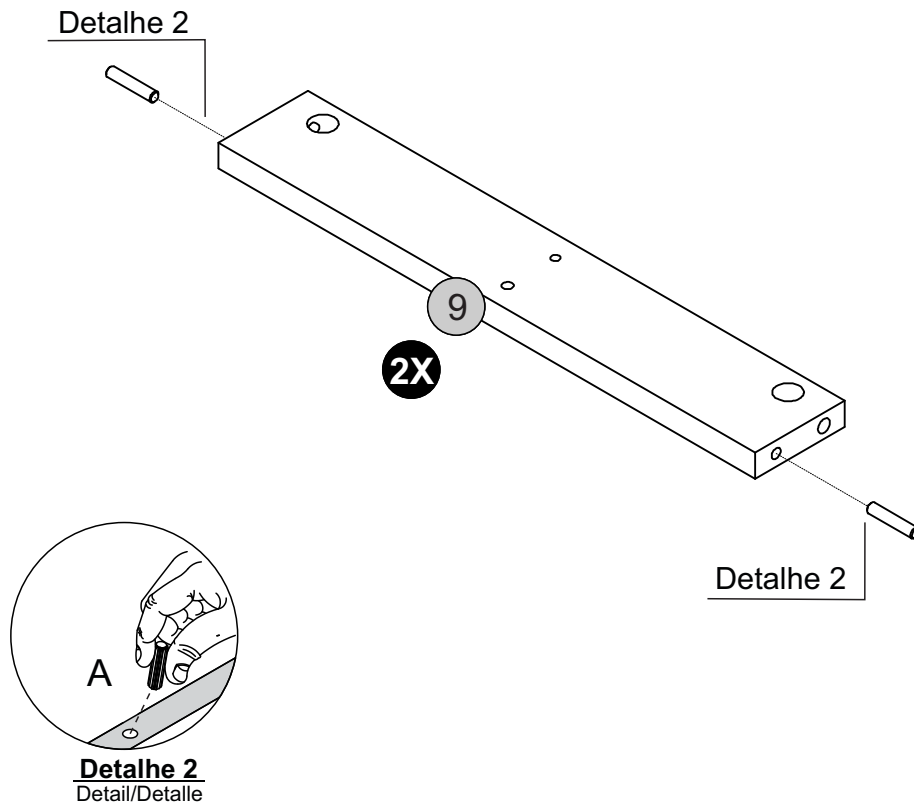
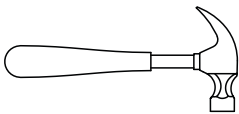

# Passo 10

Paso/Step

**PEÇA**  
Pieza/Piece

8 - TRAVESSA INFERIOR x1

**FERRAGEM**  
Herraje/Hardware

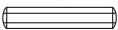
A  02

**FERRAMENTA**  
Herramienta/Tool

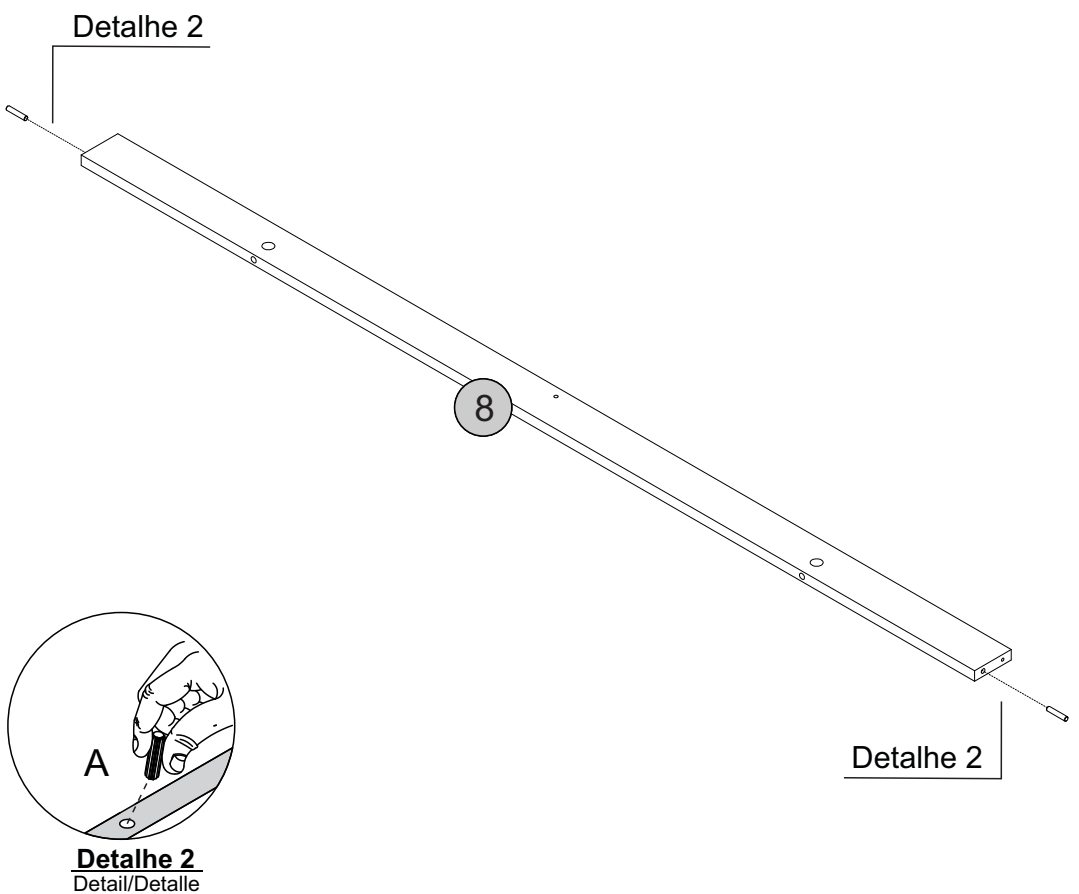
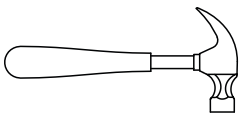



# Passo 11

Paso/Step

**PEÇA**  
Pieza/Piece

13 - PORTA x2

14 - ALMOFADA x2

**FERRAGEM**  
Herraje/Hardware

F  20

P  20

**FERRAMENTA**  
Herramienta/Tool

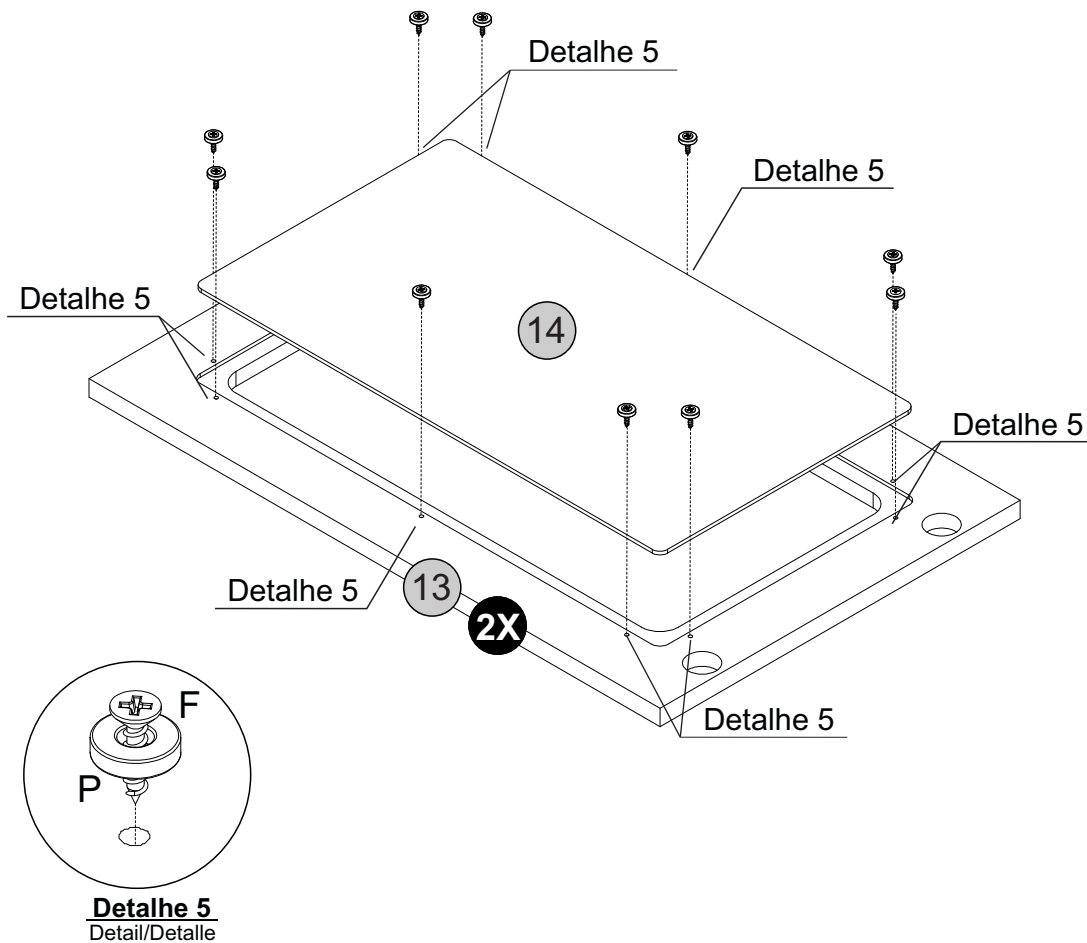
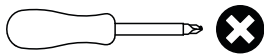

# Passo 12

Paso/Step

**PEÇA**  
Pieza/Piece

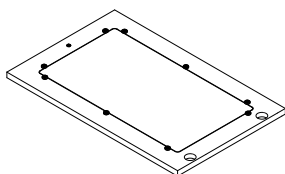

**FERRAGEM**  
Herraje/Hardware

E  08

K  04

**FERRAMENTA**  
Herramienta/Tool

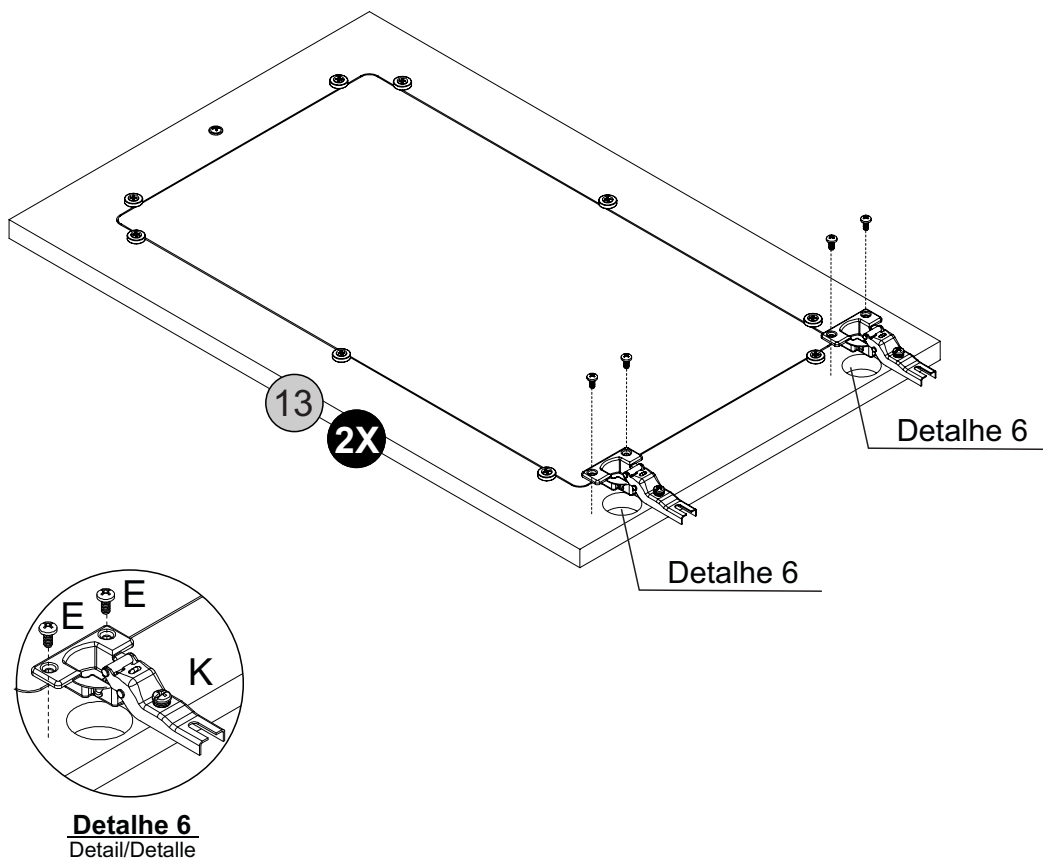
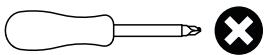

# Passo 13

Paso/Step

## PEÇA

Pieza/Piece

3 - PRATELEIRA FIXA x1

7 - DIVISÃO ESQUERDA x1

## FERRAGEM

Herraje/Hardware

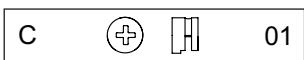

## FERRAMENTA

Herramienta/Tool

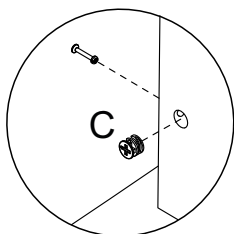
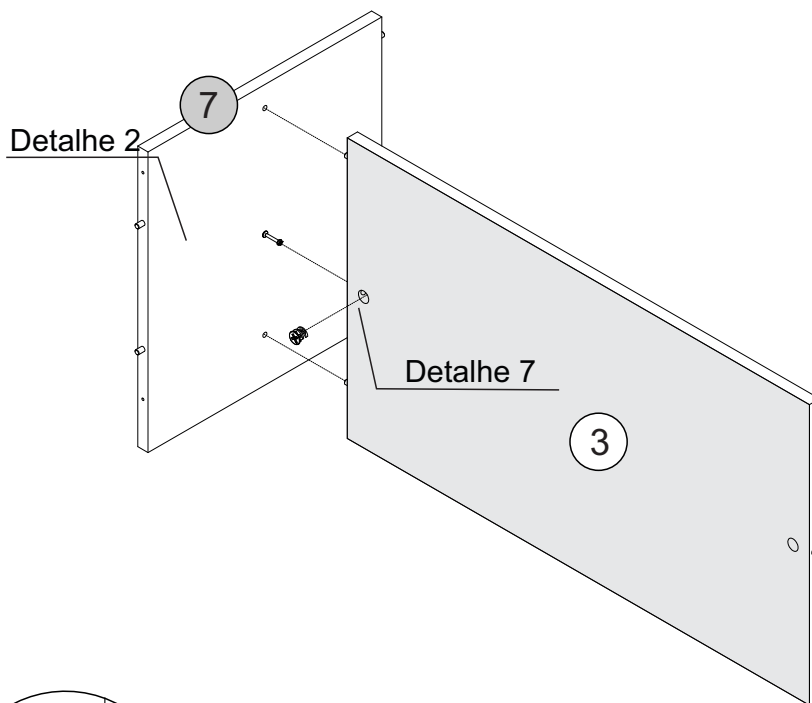
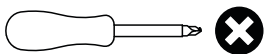

**Detalhe 7**  
Detalle/Detail

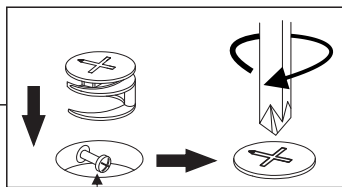

**Cabeça do parafuso precisa estar no centro**  
La cabeza del tornillo debe estar en el centro  
Screw head has to be in the center

# Passo 14

Paso/Step

## PEÇA

Pieza/Piece

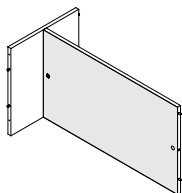

6 - DIVISÃO DIREITA x1

## FERRAGEM

Herraje/Hardware

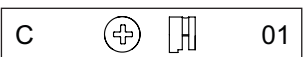

## FERRAMENTA

Herramienta/Tool

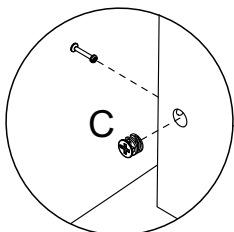
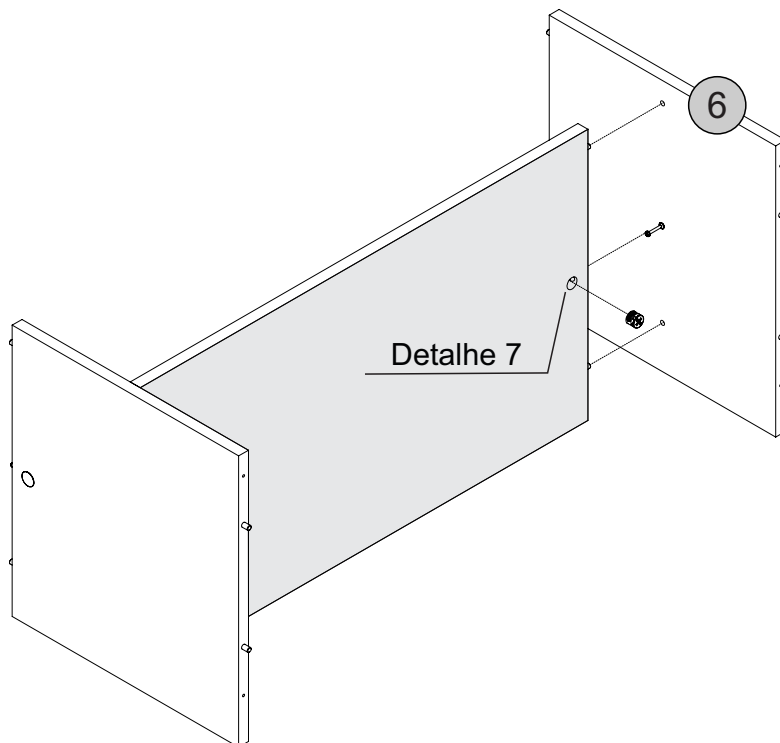
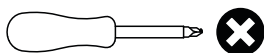

**Detalhe 7**  
Detalle/Detail

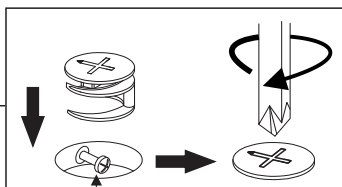

**Cabeça do parafuso precisa estar no centro**  
La cabeza del tornillo debe estar en el centro  
Screw head has to be in the center

# Passo 15

Paso/Step

## PEÇA Pieza/Piece

8 - TRAVESSA INFERIOR x1

9 - TRAVESSA DOS PÉS x2

## FERRAGEM Herraje/Hardware

D  x2

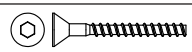
I  x2

## FERRAMENTA Tool/Herramienta

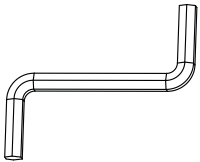

Detalhe 8

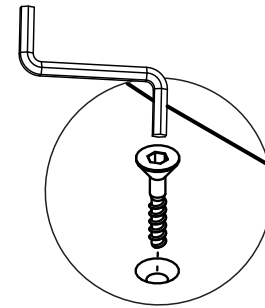
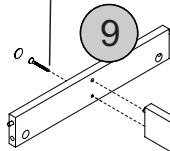

Detalhe 10  
Detail/Detalle

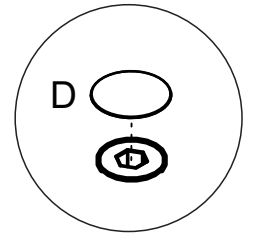

Detalhe 9  
Detail/Detalle

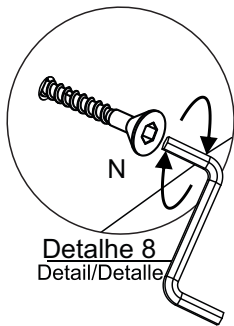

Detalhe 8  
Detail/Detalle

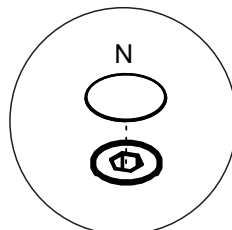

Detalhe 9  
Detail/Detalle

Detalhe 8

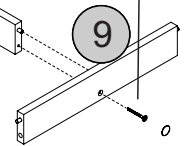

# Passo 16

Paso/Step

## PEÇA Pieza/Piece

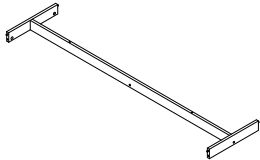



10 - PÉ ESQUERDO x2

11 - PÉ DIREITO x2

12 - PÉ CENTRAL x1

## FERRAGEM Herraje/Hardware

C   x4

D  x5

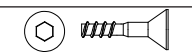
J  x1

## FERRAMENTA Herramienta/Tool

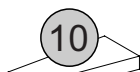
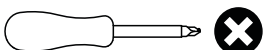

Detalhe 7

Detalhe 10

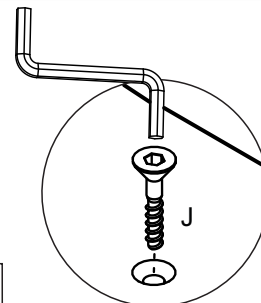

Detalhe 10  
Detail/Detalle

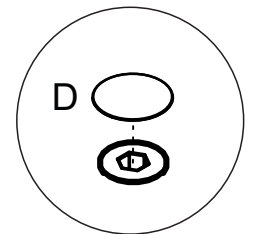

Detalhe 9  
Detail/Detalle

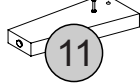

Detalhe 7

Detalhe 7

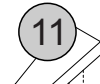

Detalhe 7

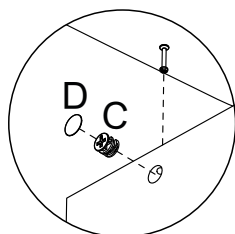

Detalhe 7  
Detalle/Detail

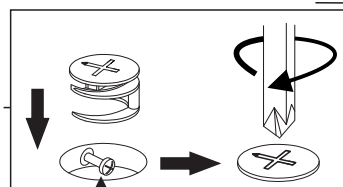

Cabeça do parafuso precisa estar no centro  
La cabeza del tornillo debe estar en el centro  
Screw head has to be in the center

# Passo 17

Paso/Step

**PEÇA**  
Pieza/Piece

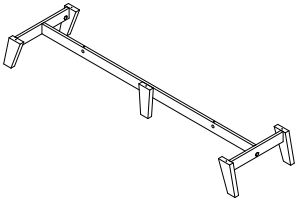

2 - BASE x1

**FERRAGEM**  
Herraje/Hardware

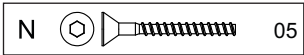

**FERRAMENTA**  
Tool/Herramienta

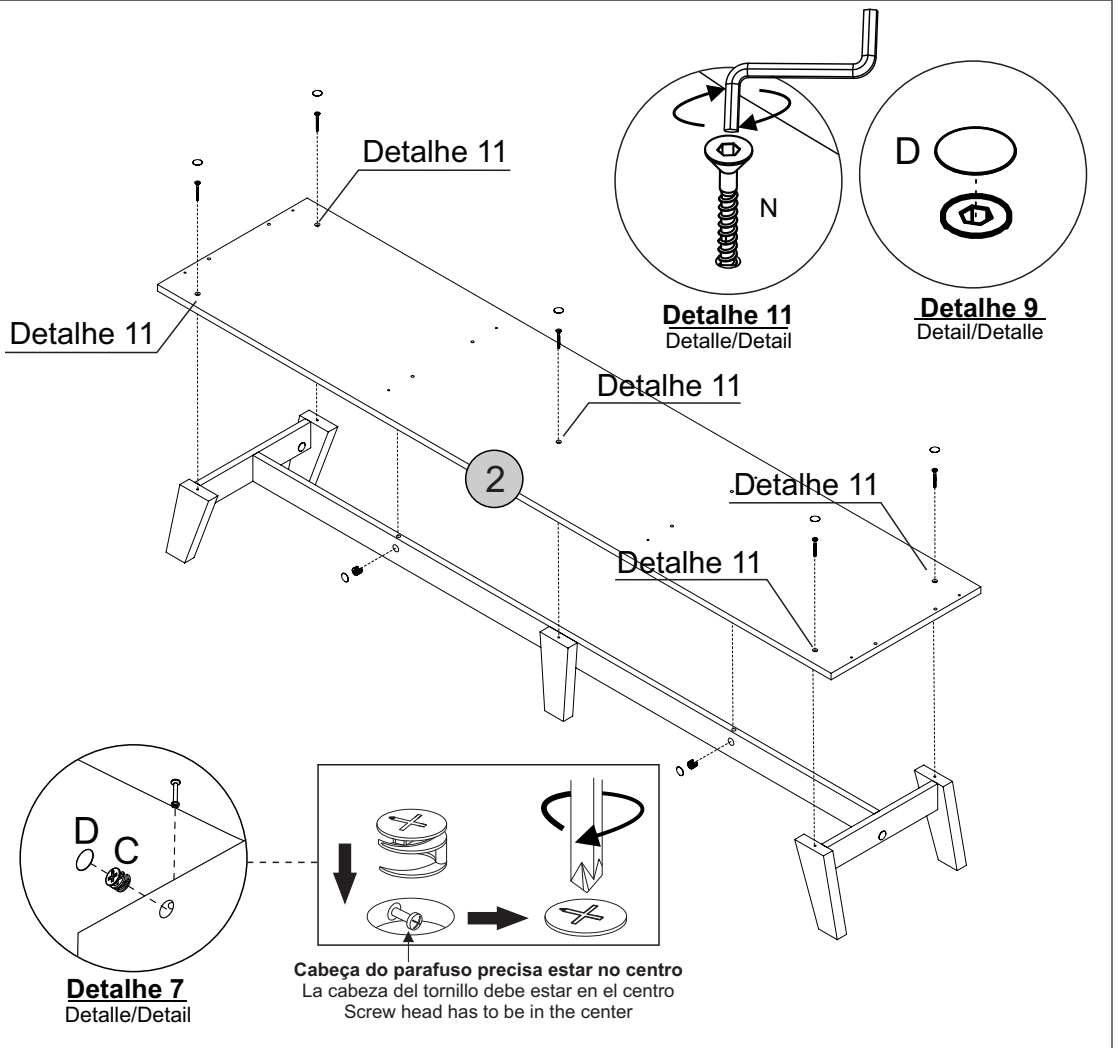
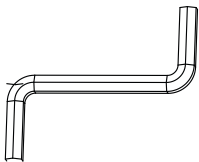

# Passo 18

Paso/Step

**PEÇA**  
Pieza/Piece

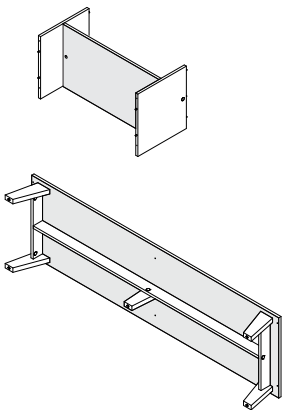

**FERRAMENTA**  
Herramienta/Tool



**FERRAMENTA**  
Herramienta/Tool

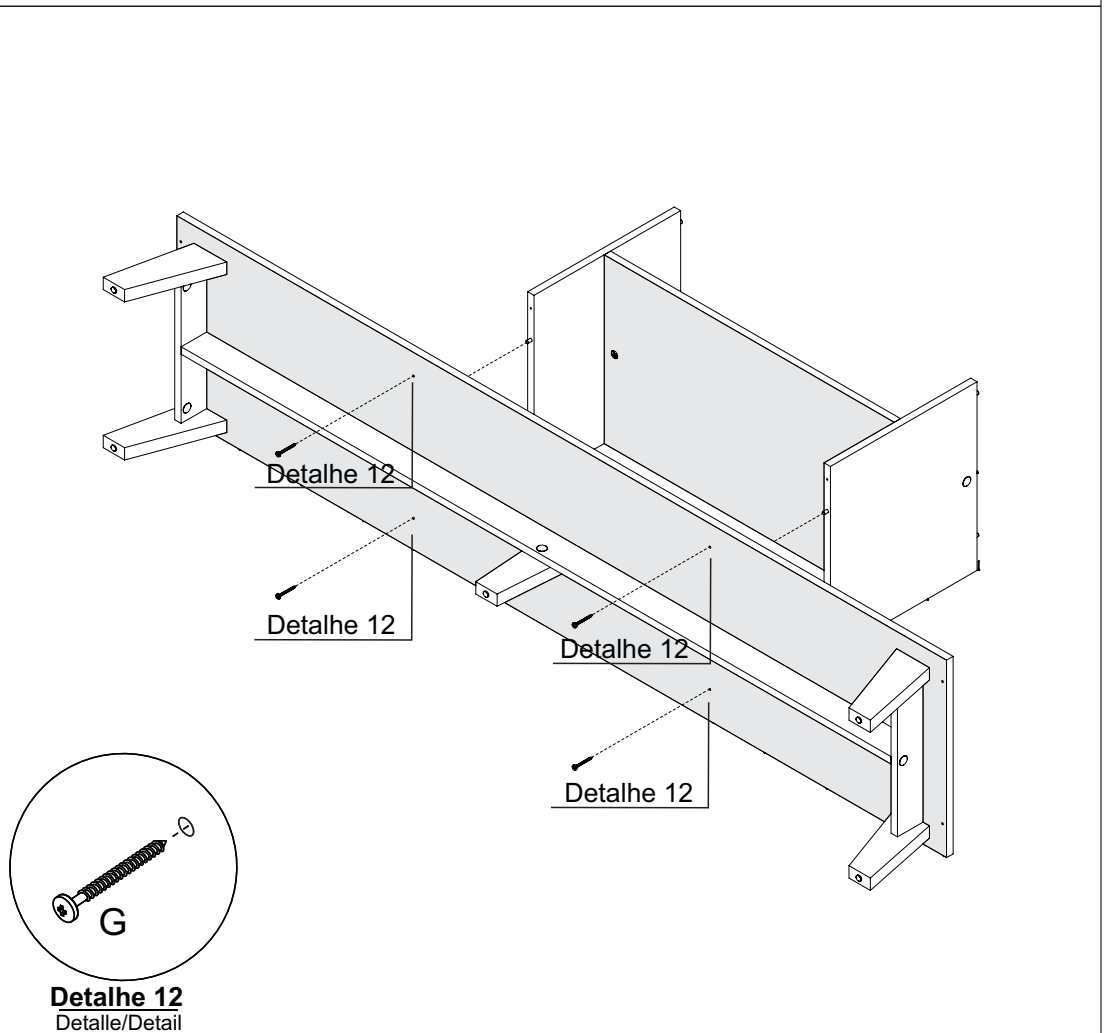
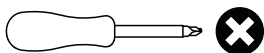

# Passo 19

Paso/Step

**PEÇA**  
Pieza/Piece

5 - LATERAL ESQUERDA x1

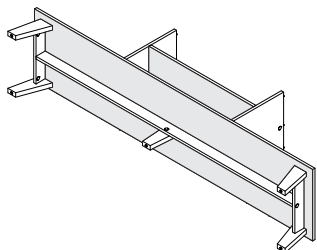

**FERRAMENTA**  
Herramienta/Tool

G  02

**FERRAMENTA**  
Herramienta/Tool

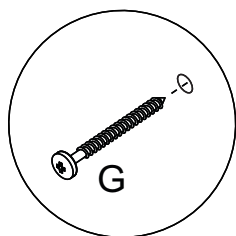
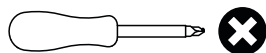

**Detalhe 12**  
Detalle/Detail

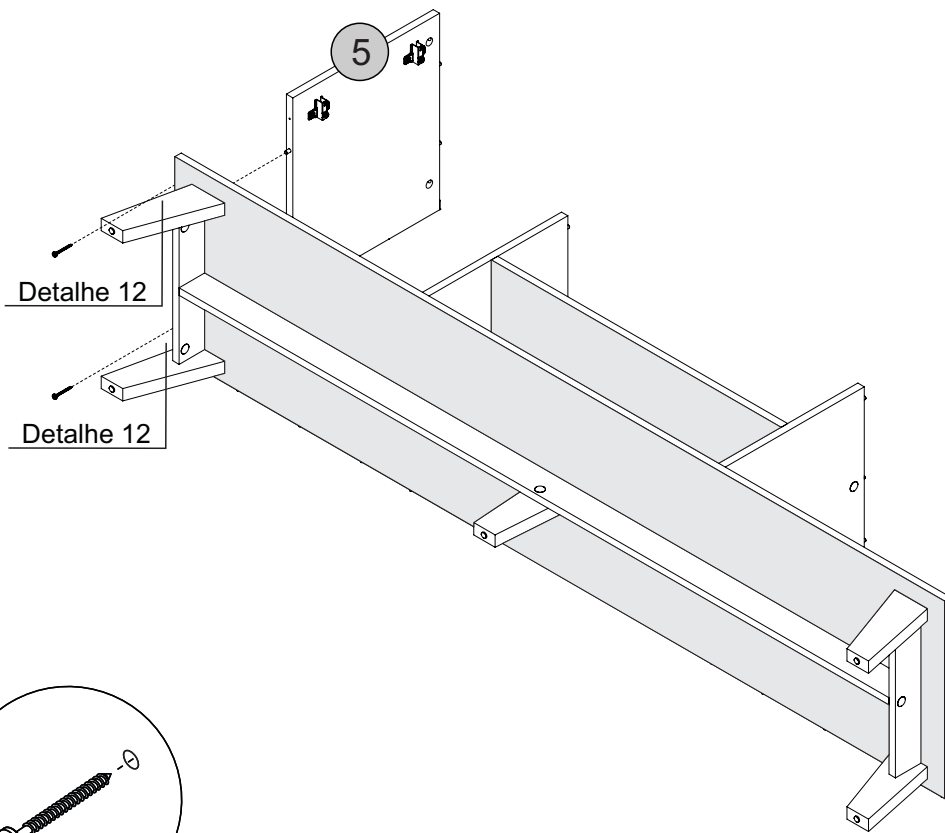

# Passo 20

Paso/Step

**PEÇA**  
Pieza/Piece

4 - LATERAL DIREITA x1

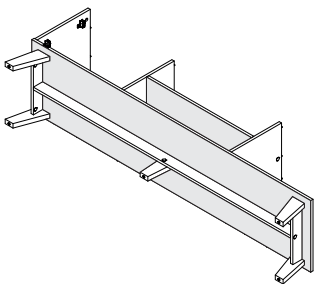

**FERRAMENTA**  
Herramienta/Tool

G  02

**FERRAMENTA**  
Herramienta/Tool

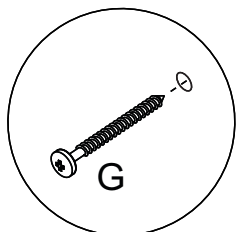
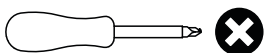

**Detalhe 12**  
Detalle/Detail

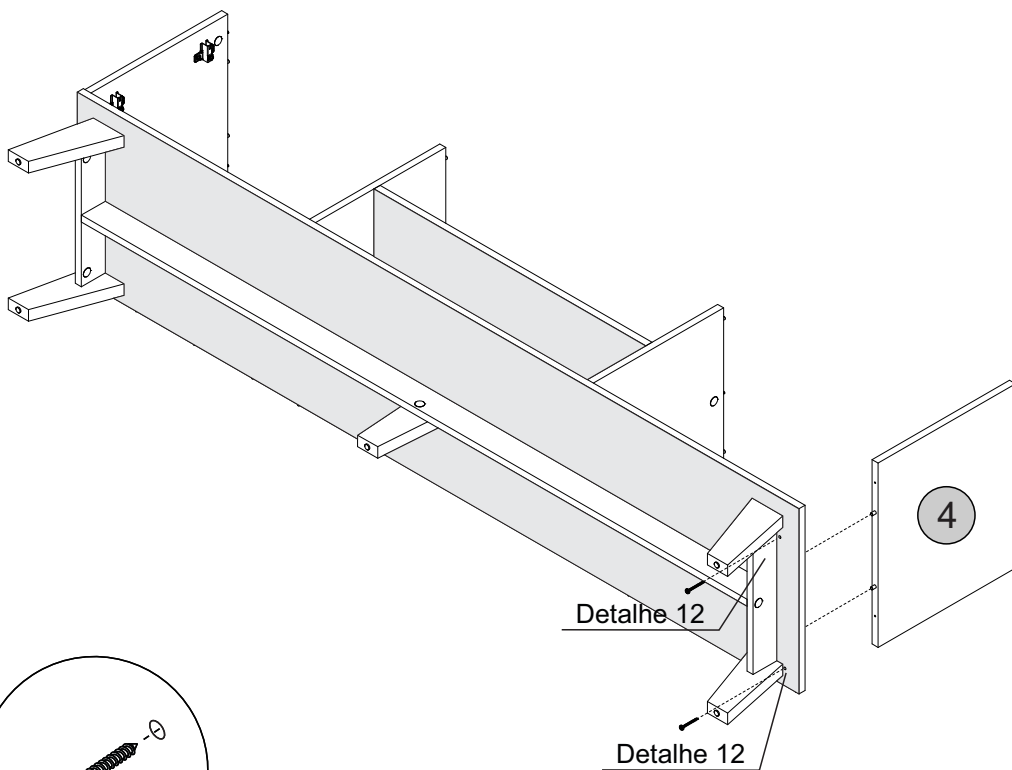

# Passo 21



Paso/Step

**PEÇA**  
Pieza/Piece

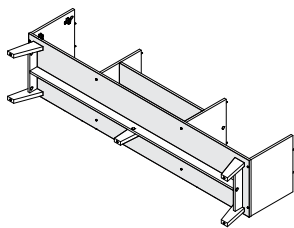
1 - TAMPO x1



**FERRAGEM**  
Herraje/Hardware

C   06

**FERRAMENTA**  
Herramienta/Tool

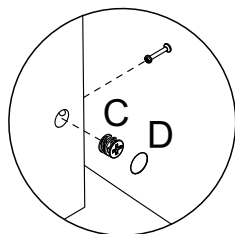
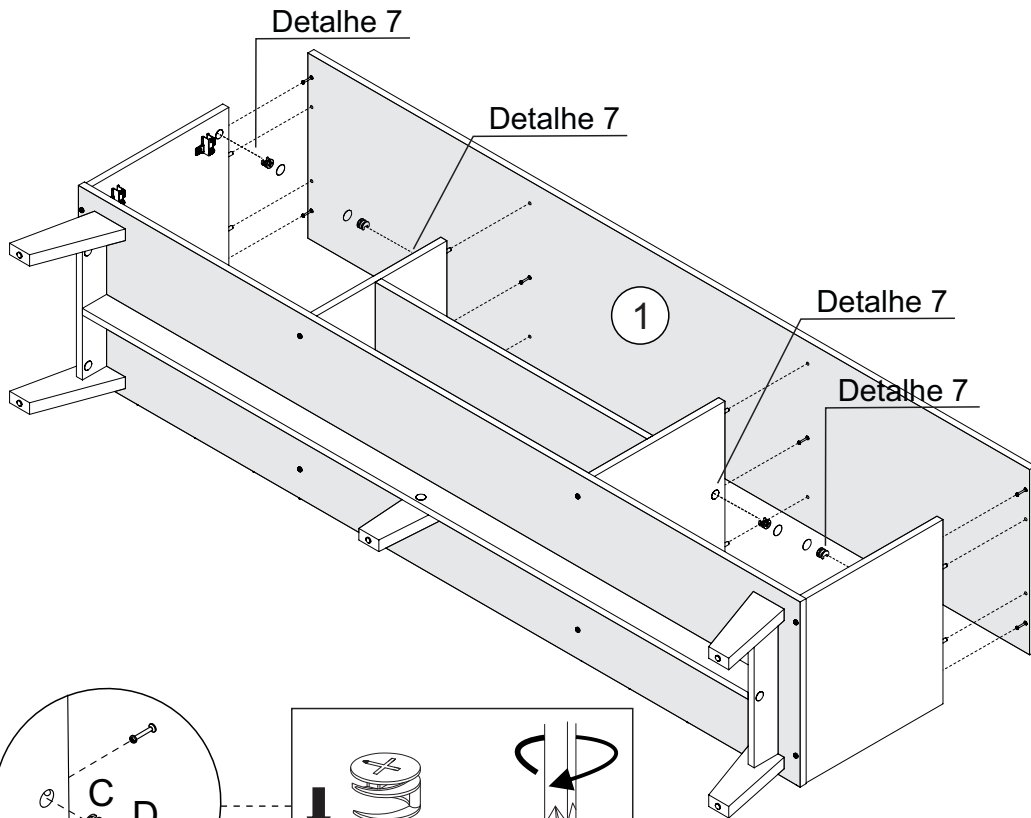
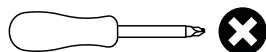

**Detalhe 7**  
Detalle/Detail

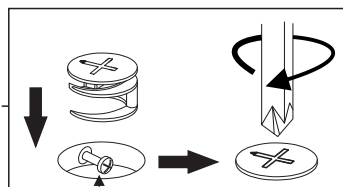

**Cabeça do parafuso precisa estar no centro**  
La cabeza del tornillo debe estar en el centro  
Screw head has to be in the center

# Passo 22

Paso/Step

**PEÇA**  
Pieza/Piece

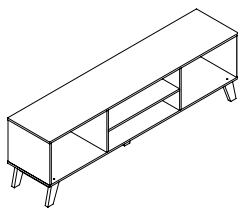

15 - TRASEIRO x1

**FERRAGEM**  
Hardware/Herraje

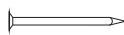
H  28

**FERRAMENTA**  
Tool/Herramienta

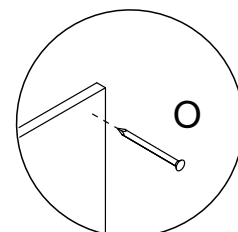
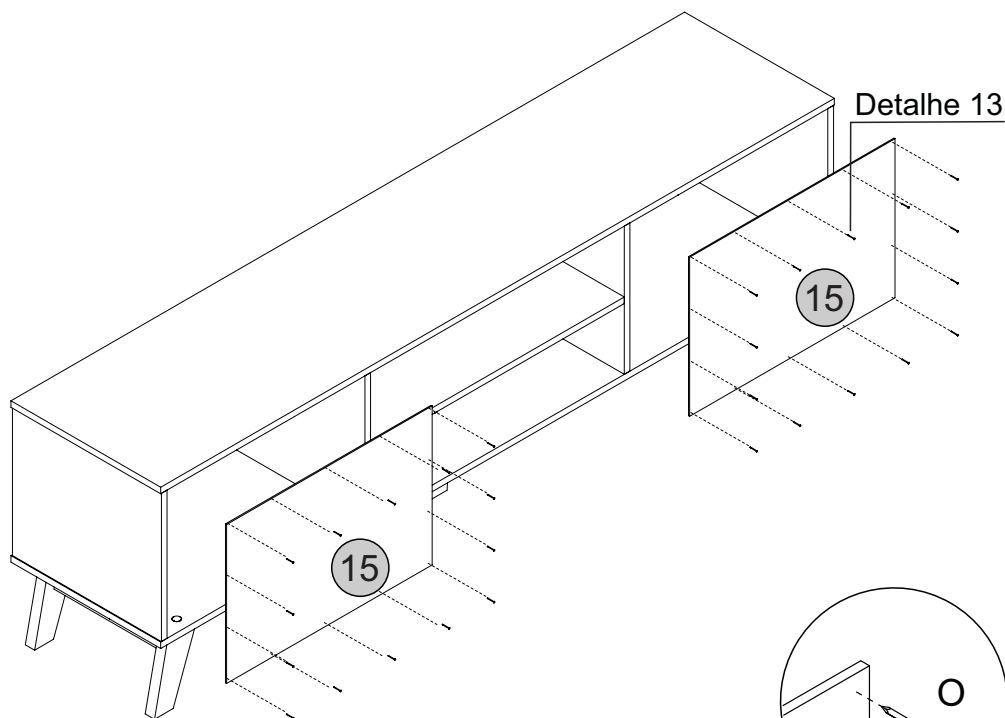
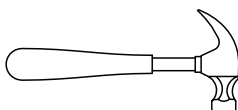

**Detalhe 13**  
Detail/Detalle

# Passo 23

Paso/Step

**PEÇA**  
Pieza/Piece

13 - PORTA x2

**FERRAGEM**  
Herraje/Hardware

H  02

M  02

**FERRAMENTA**  
Herramienta/Tool

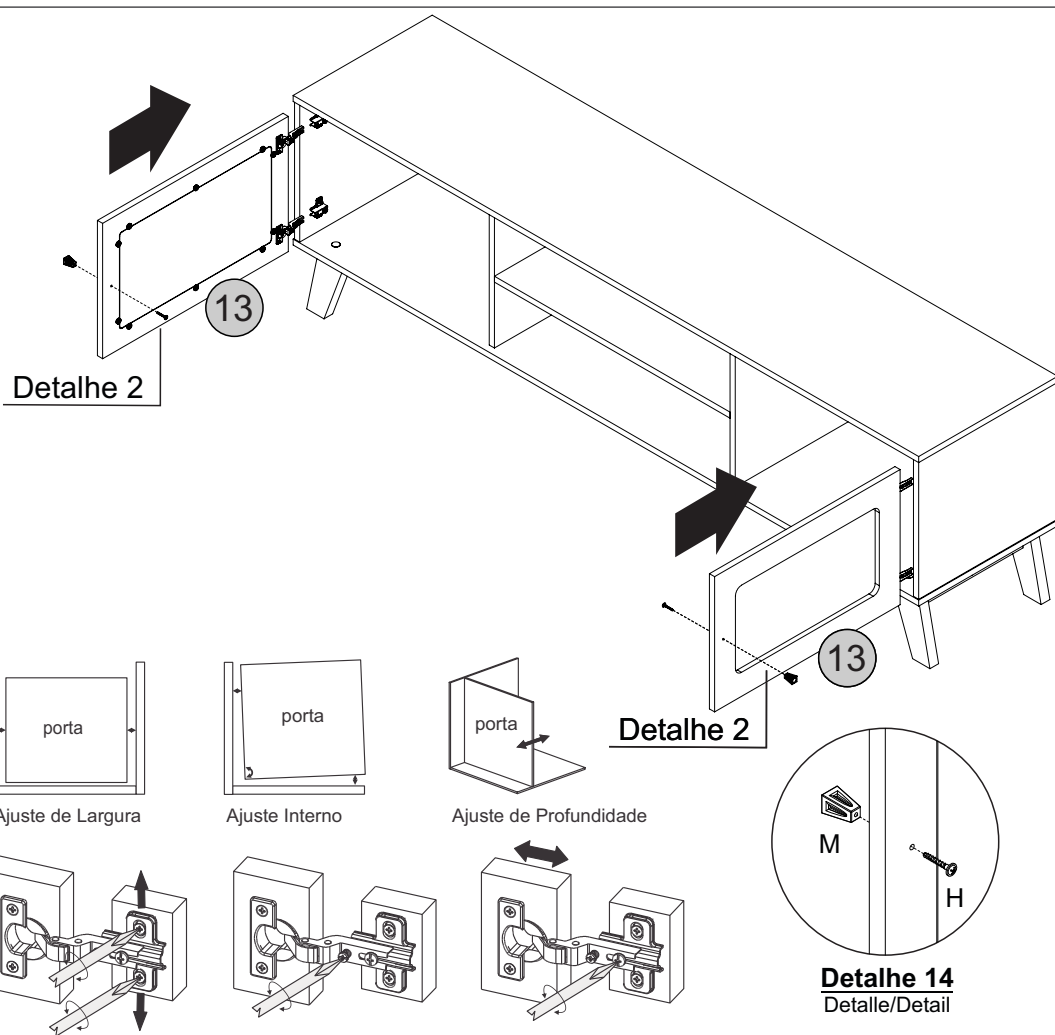
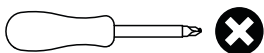

# Passo 24

Paso/Step

**PEÇA**  
Pieza/Piece

**FERRAGEM**  
Herraje/Hardware

**FERRAMENTA**  
Herramienta/Tool

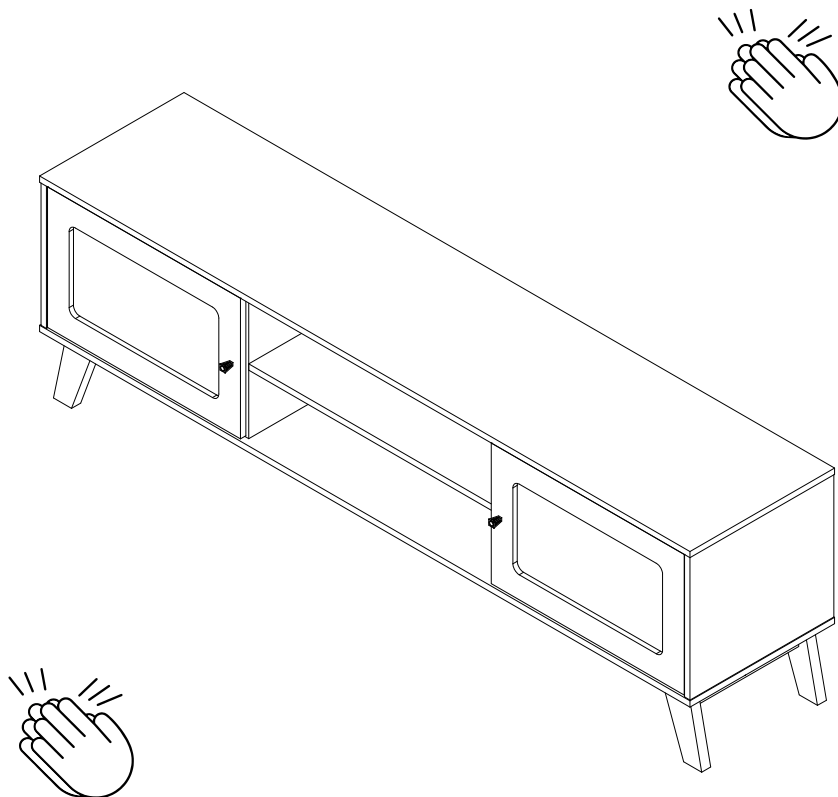

**Parabéns, você montou seu móvel! Agora é só decorar sua casa e aproveitar!**

**Queremos ver como ficou o móvel Artely do seu jeito... Marque a gente com a #meuartely. Ficaremos felizes em compartilhar!**

**Ah, e se tiver qualquer dúvida, sugestão ou comentário, entra em contato com a gente pelo nosso site [www.artely.com.br](http://www.artely.com.br).**

¡Congratulaciones, montaste tu mueble! ¡Ahora solo decora tu casa y disfruta!

Queremos ver este producto en tu hogar, a tu manera... Utilice #meuartely, ¡ficaremos encantados de compartir tu foto!

Si tienes alguna duda, sugerencia o comentario, contáctenos a través de nuestro sitio web [www.artely.com.br](http://www.artely.com.br).

Congratulations, you've assembled your new furniture! Decorate your home and enjoy!

We want to see how this product is in your home... Use #meuartely, we will be happy to share your picture!

If you have any doubt, suggestion or comment, get in touch with us through our website [www.artely.com.br](http://www.artely.com.br).