

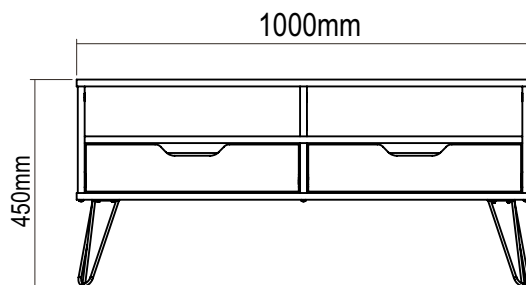

Mesa de Centro Estocolmo

Mesa Centrar Estocolmo / Center Table Estocolmo

Versão 1.0 / Versión 1.0 / 1.0 Version

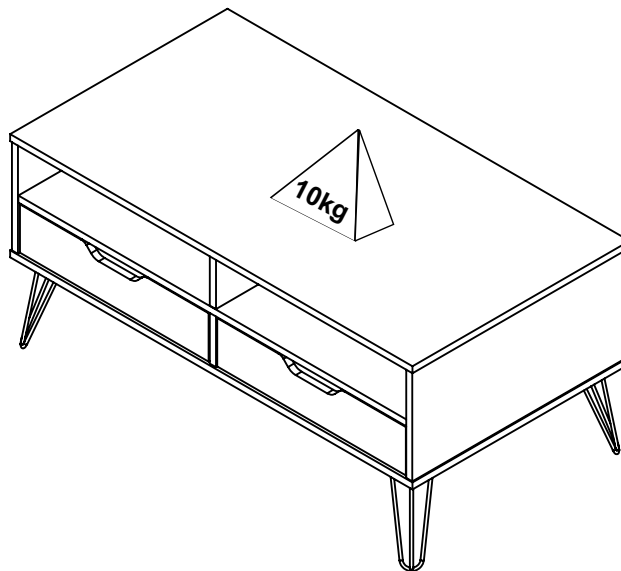

frente/frente/front

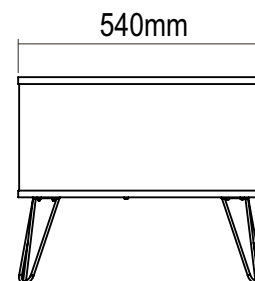

lateral/lado/side

Conservação e Limpeza - Conservación y Limpieza - Conservation and Cleaning

Não expor o produto ao sol, altas temperaturas e umidade. Não arrastar objetos sobre a superfície do móvel (ex.: TV, DVD, aparelho de som, objetos decorativos...) e manter em local seco e arejado. Para a limpeza, utilizar um pano seco e macio. Não é necessário o uso de materiais abrasivos ou álcool.

No exponga el producto a la luz solar, las altas temperaturas y la humedad. No arrastre los objetos a través de la superficie de la unidad (por ejemplo, TV, DVD, equipo de música, objetos de decoración ...) Mantener en un lugar fresco y seco.

Para la limpieza, utilizar un paño seco y suave. El uso de materiales abrasivos o del alcohol no es necesario.

Do not expose the product to sunlight, high temperatures and humidity. Do not drag objects across the surface of the unit (TV, DVD, stereo, decorative objects ...) keep it in a cool dry place. For cleaning, use a dry and soft cloth. Do not use abrasive materials or alcohol.

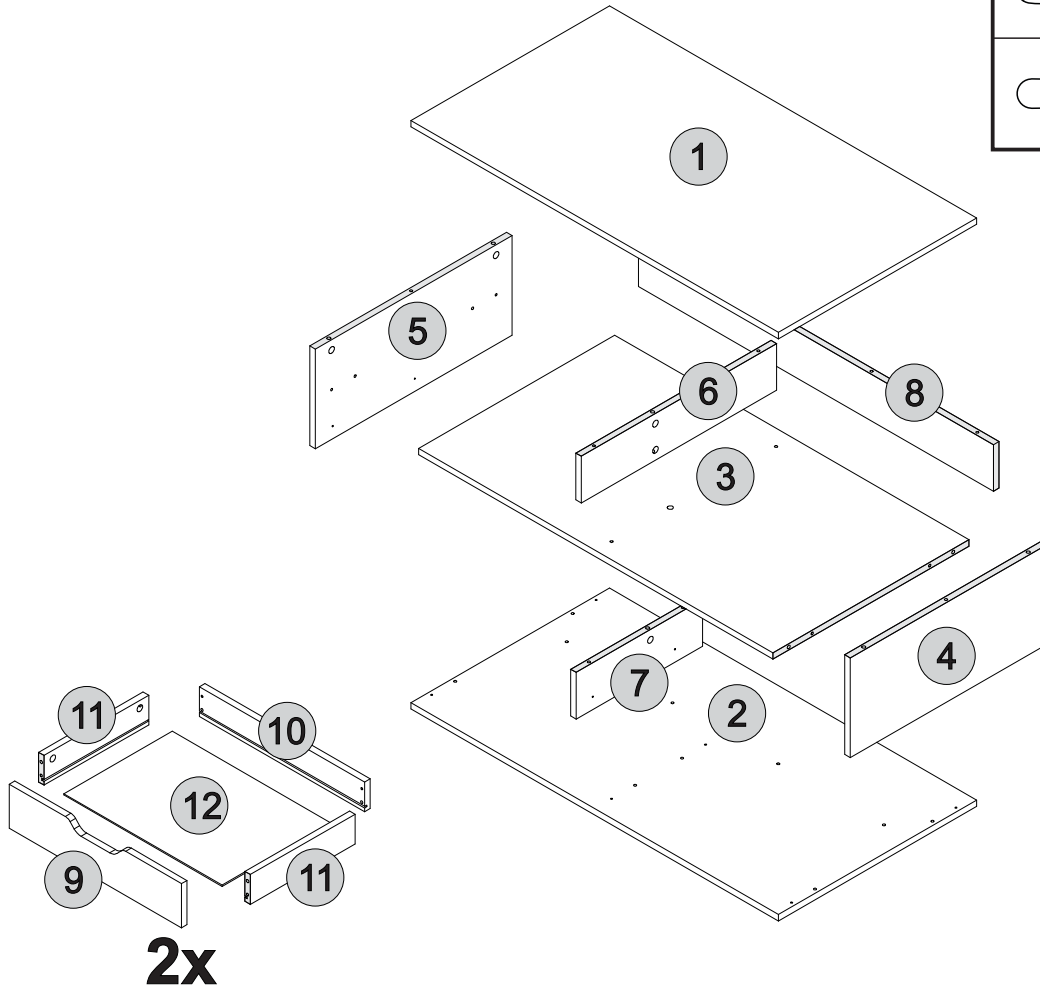
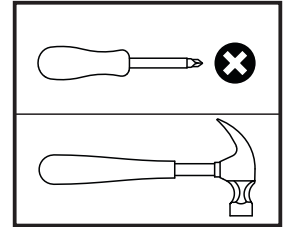



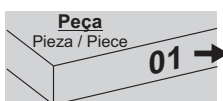

Descrição	Descripción	Description	Qty
1-Tampo (1000x540x15mm)	1-Tapa	1-Top	1
2-Base (100x540x15mm)	2-Base	2-Base	1
3-Prateleira Fixa (965x534x15mm)	3-Anaqueil Reparado	3-Fixed Shelf	1
4-Lateral Direita (536x235x15mm)	4-Lado Derecho	4-Right Side	1
5-Lateral Esquerda (536x235x15mm)	5-Lado Izquierdo	5-Left Side	1
6-Divisão Superior (532x110x15mm)	6-División Arriba	6-Higher Division	1
7-Divisão Inferior (344x110x15mm)	7-División Fondo	7-Bottom Division	1
8-Traseira (966x110x15mm)	8-Trasero	8-Back	1
9-Frente Gaveta (469x104x15mm)	10-Cajón Frontal	10-Drawer Front	2
10-Traseira Gaveta (450x70x15mm)	11-Trasero del Cajón	11-Drawer Back	2
11-Lateral Gaveta (285x70x15mm)	12-Lado del Cajón	12-Drawer Side	4
12-Fundo Gaveta (431x295x15mm)	13-Fundo del Cajón	13-Drawer Botton	2

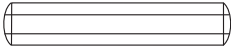
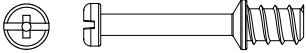
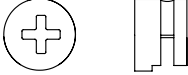

- O número na borda da peça corresponde ao manual.
- Para retirada do número usar Lustra-Móveis, Álcool em Gel ou Borracha.
- El número en el borde de la pieza coincide con el manual.
- Use una goma de borrar blanca, alcohol en gel o lustrador para muebles para eliminar los números.
- The number on the edge of the piece matches the manual.
- Use a White eraser, Alcohol Gel or Furniture Polish to remove the numbers.

Lista de Materiais

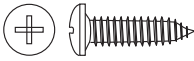
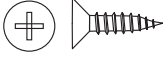
Lista de Materiales/ Hardware List

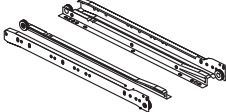
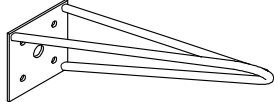
A		Cavilha / Tarugo / Dowel Ø6x30mm	34
B		Minifix / Minifix / Minifix Ø7x30mm	17
C		Tambor / Tambor / Minifix Cam Ø15x12mm	19
D		Tapa furo adesivo / Adhesivo / Hole Cover Ø18mm	15
E		Parafuso Tornillo / Screw Ø3,5x40mm CP	06
F		Parafuso Tornillo / Screw Ø4,0x14mm CP	16
G		Parafuso Tornillo / Screw Ø3,5x12mm CP	16
H		Haste Dupla Varilla Doble / Double Rod	01
I		Corrediça Guía / Slider 350mm	02
J		Pé Metal Foot Metal / Pie de Metal	04

DICA PARA FIXAR MINIFIX

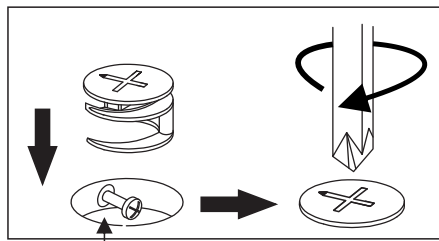

Cabeça do parafuso precisa estar no centro

Parafuso Minifix

Fixe o parafuso até o resalto encostar na superfície na peça. (veja o exemplo abaixo)

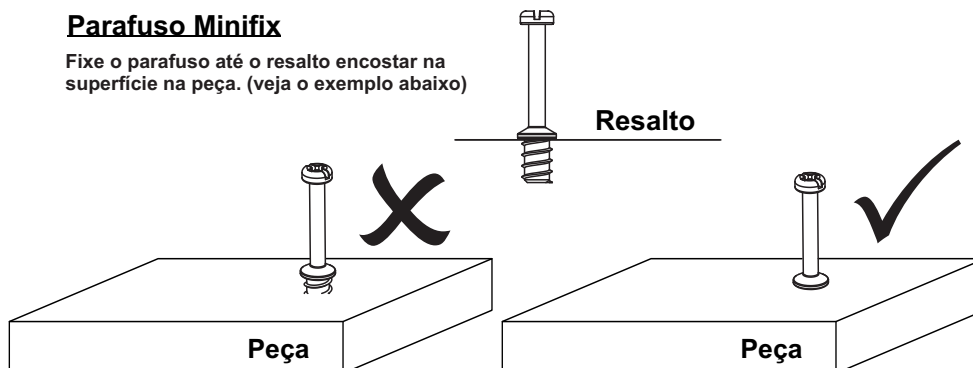

Passo 1

Paso/Step

PEÇA
Piece/Pieza

1 - TAMPO x1

FERRAGEM
Hardware/Herraje

B  05

FERRAMENTA
Tool/Herramienta

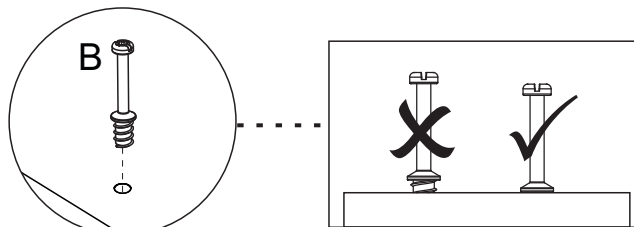
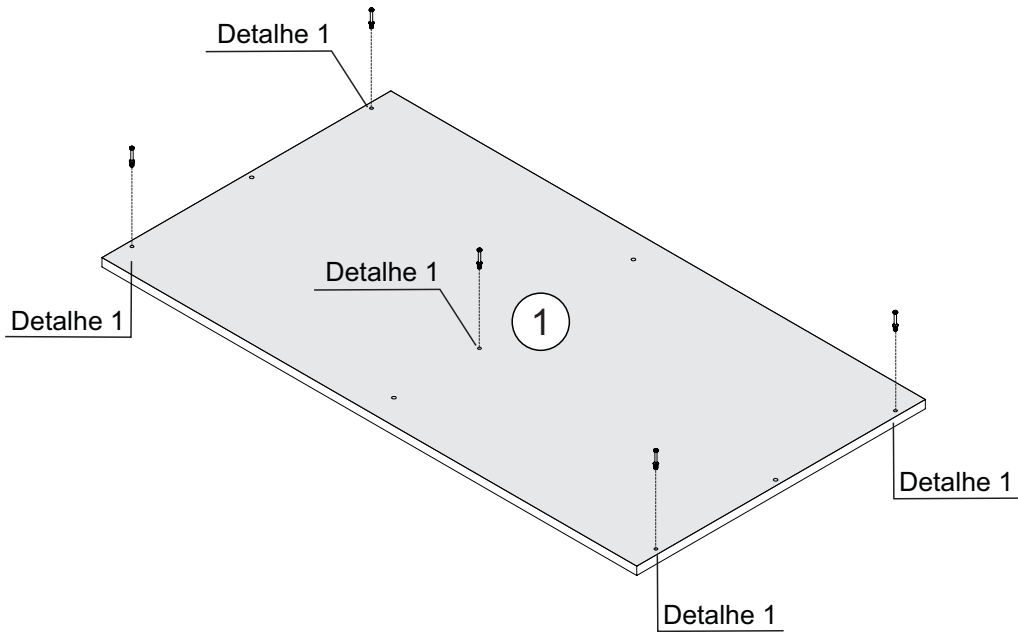
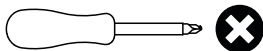

Detalhe 1
Detail/Detalle

Passo 2

Paso/Step

PEÇA
Piece/Pieza

3 - PRATELEIRA FIXA x1

FERRAGEM
Hardware/Herraje

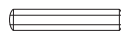
A  04

FERRAMENTA
Tool/Herramienta

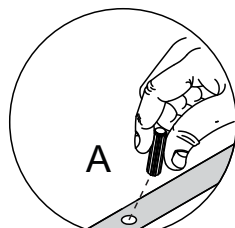
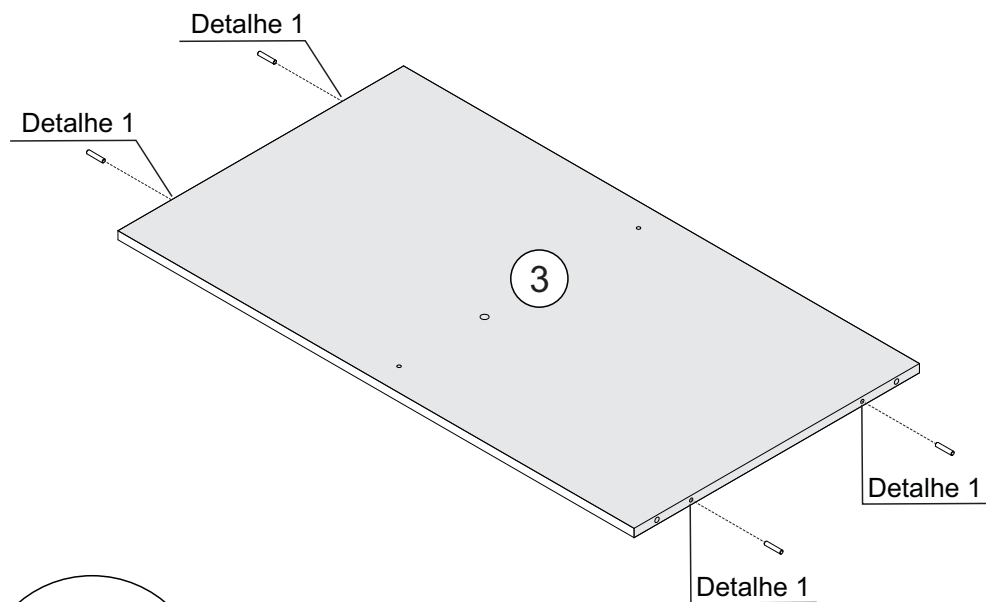
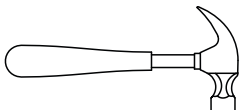

Detalhe 2
Detail/Detalle

Passo 3

Paso/Step

PEÇA

Piece/Pieza

4 - LATERAL DIREITA x1

FERRAGEM

Hardware/Herraje

A  03

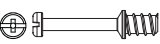
B  02

G  02

K  01

FERRAMENTA

Tool/Herramienta

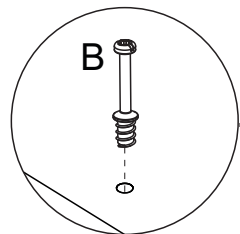
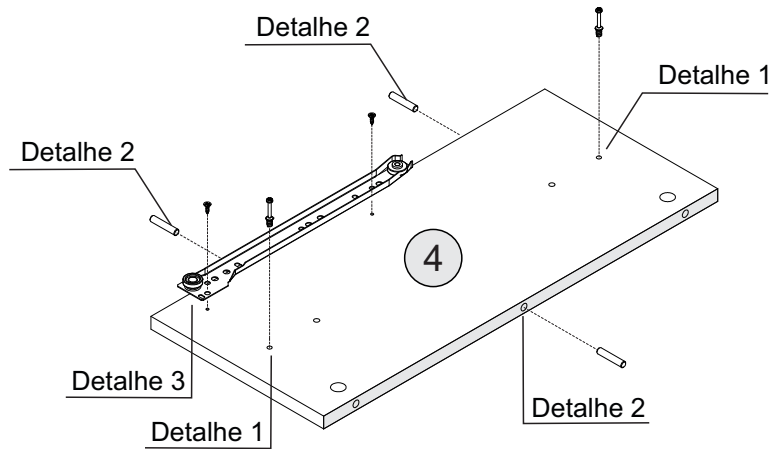
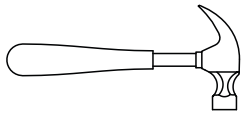
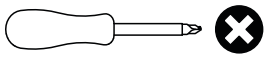

Detalhe 1
Detail/Detalle

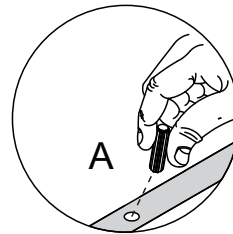

Detalhe 2
Detail/Detalle

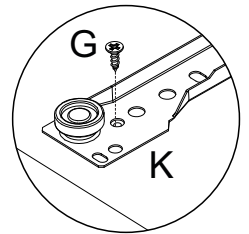

Detalhe 3
Detail/Detalle

Passo 4

Paso/Step

PEÇA

Piece/Pieza

5 - LATERAL ESQUERDA x1

FERRAGEM

Hardware/Herraje

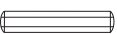
A  03

B  02

G  02

K  01

FERRAMENTA

Tool/Herramienta

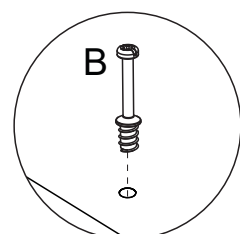
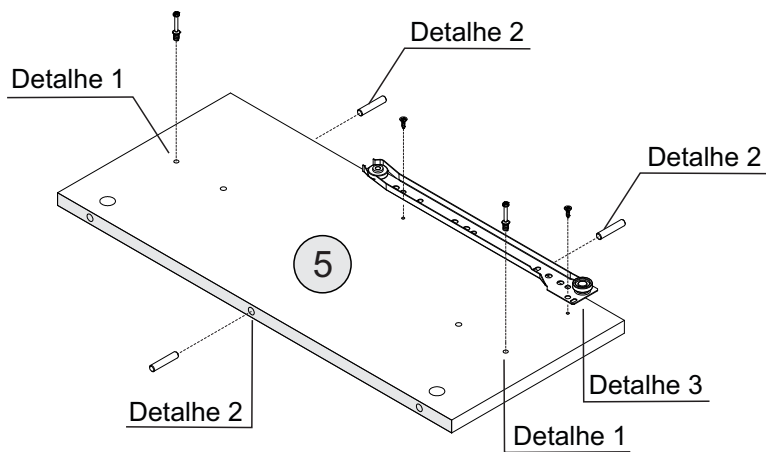
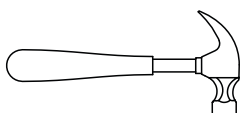
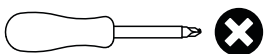

Detalhe 1
Detail/Detalle

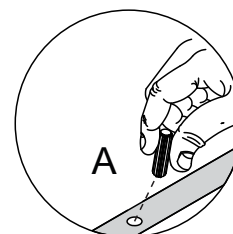

Detalhe 2
Detail/Detalle

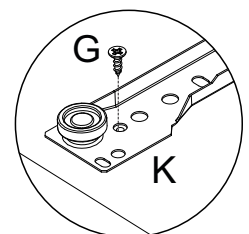

Detalhe 3
Detail/Detalle

Passo 5

Paso/Step

PEÇA
Piece/Pieza

6 - DIVISÃO SUPERIOR x1

FERRAGEM
Hardware/Herraje

A  04

FERRAMENTA
Tool/Herramienta

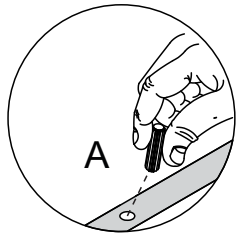
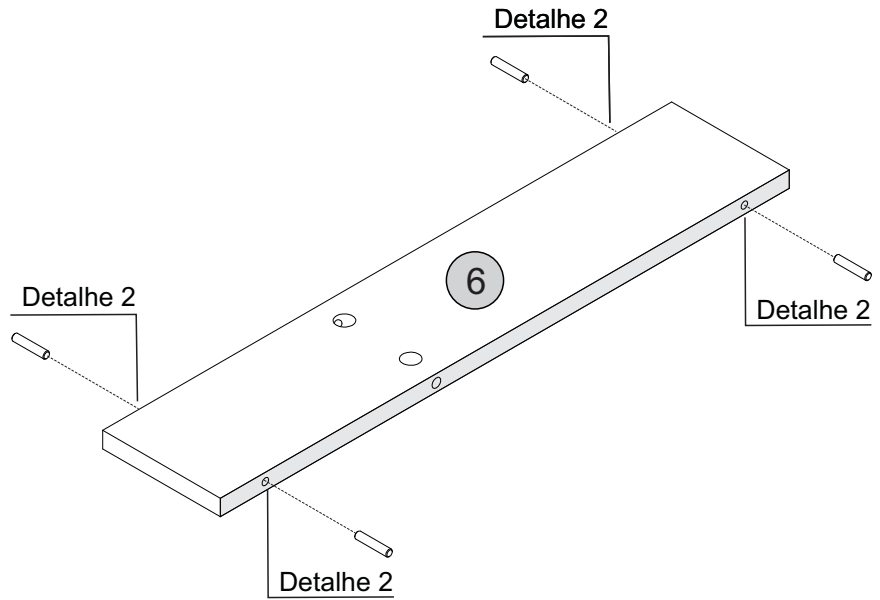
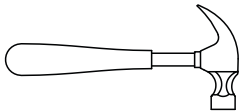

Detalhe 2
Detail/Detalle

Passo 6

Paso/Step

PEÇA
Piece/Pieza

7 - DIVISÃO INFERIOR x1

FERRAGEM
Hardware/Herraje

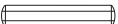
A  04

G  04

K  02

FERRAMENTA
Tool/Herramienta

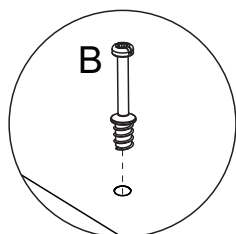
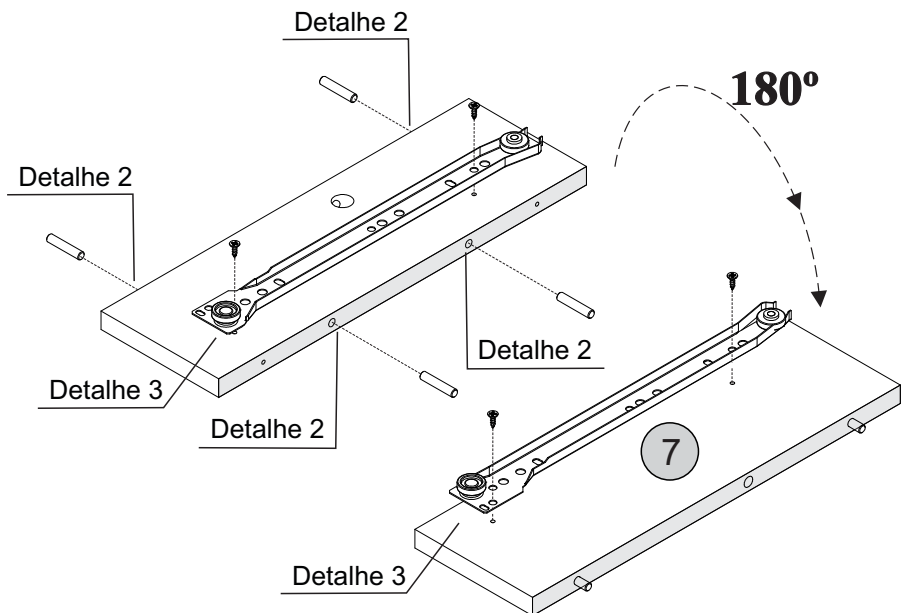
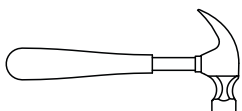
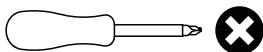

Detalhe 1
Detail/Detalle

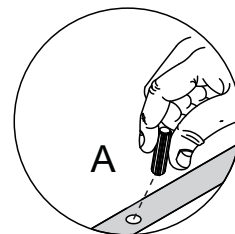

Detalhe 2
Detail/Detalle

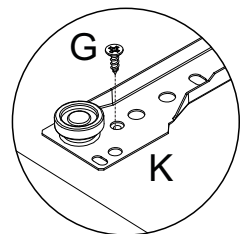

Detalhe 3
Detail/Detalle

Passo 7

Paso/Step

PEÇA
Piece/Pieza

8 - TRASEIRA x1

FERRAGEM
Hardware/Herraje

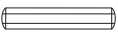
A  08

FERRAMENTA
Tool/Herramienta

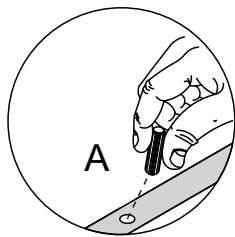
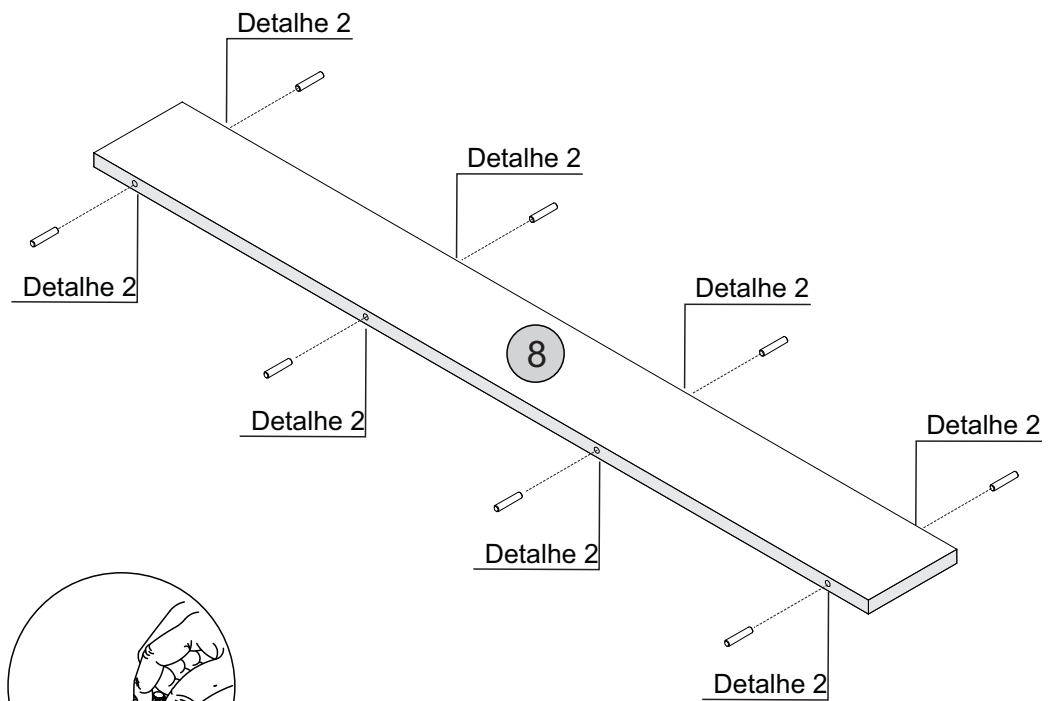
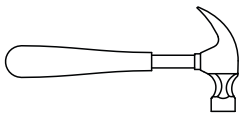

Detalhe 2
Detail/Detalle

Passo 8

Paso/Step

PEÇA
Piece/Pieza

3 - PRATELEIRA FIXA x1

6 - DIVISÃO SUPERIOR x1

7 - DIVISÃO INFERIOR x1

FERRAGEM
Hardware/Herraje

C   02

D  02

FERRAMENTA
Tool/Herramienta

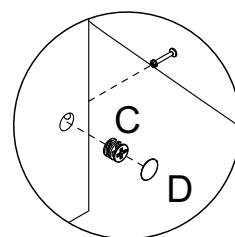
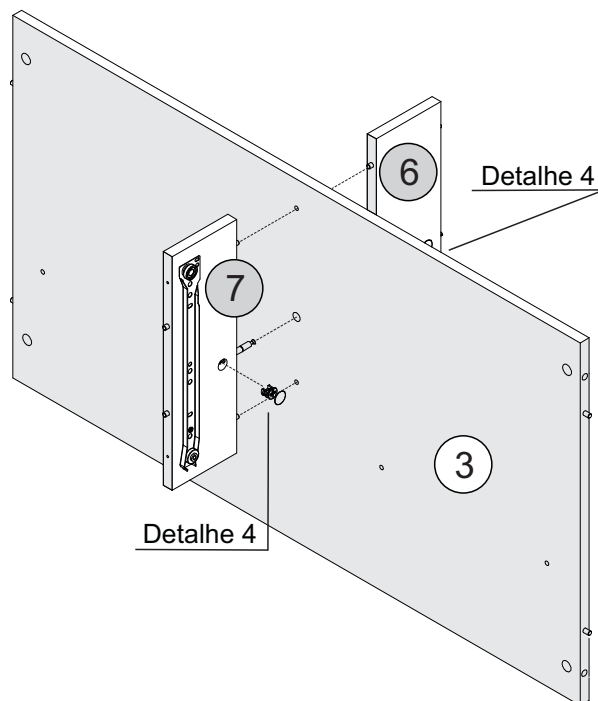
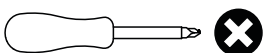

Detalhe 4
Detail/Detalle

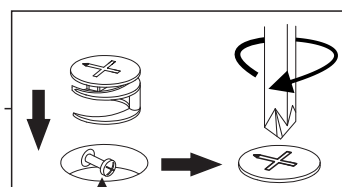

Cabeça do parafuso precisa estar no centro
La cabeza del tornillo debe estar en el centro
Screw head has to be in the center

Passo 9

Paso/Step

PEÇA
Piece/Pieza

5 - LATERAL ESQUERDA x1

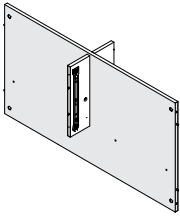

FERRAGEM
Hardware/Herraje

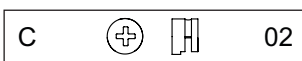

FERRAMENTA
Tool/Herramienta

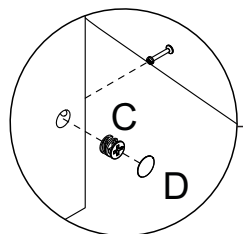
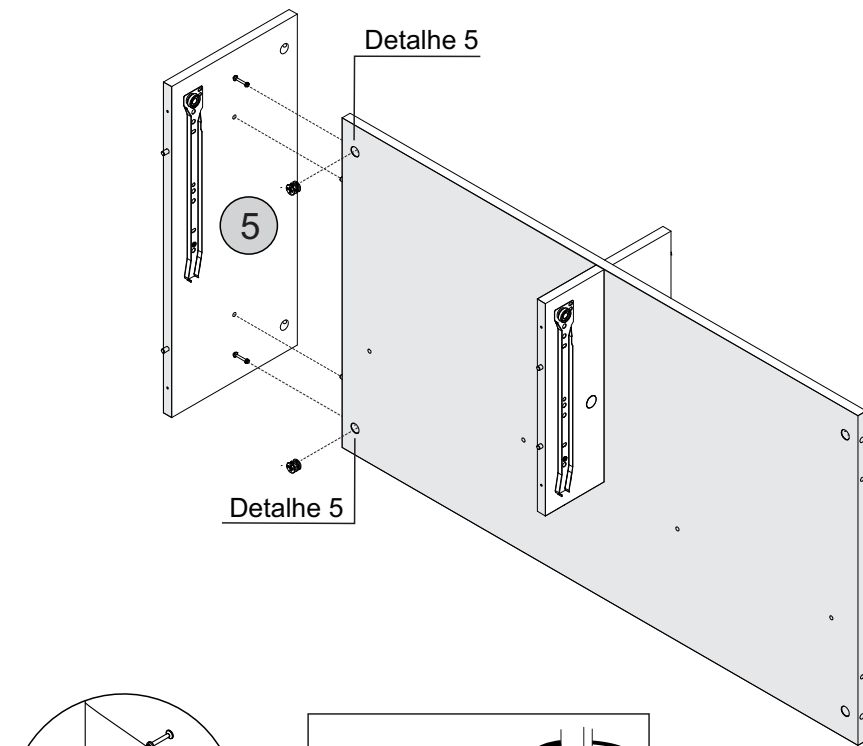
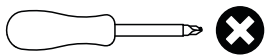

Detalhe 5
Detail/Detalle

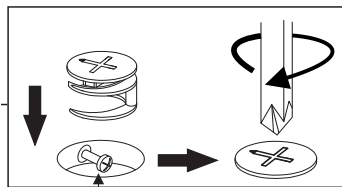

Cabeça do parafuso precisa estar no centro
La cabeza del tornillo debe estar en el centro
Screw head has to be in the center

Passo 10

Paso/Step

PEÇA
Piece/Pieza

4 - LATERAL DIREITA x1

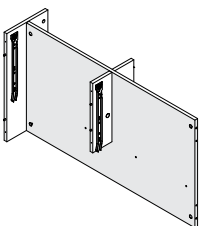

FERRAGEM
Hardware/Herraje

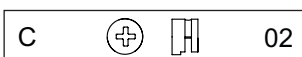

FERRAMENTA
Tool/Herramienta

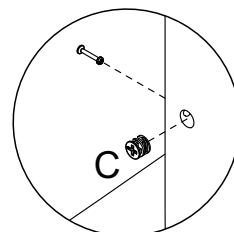
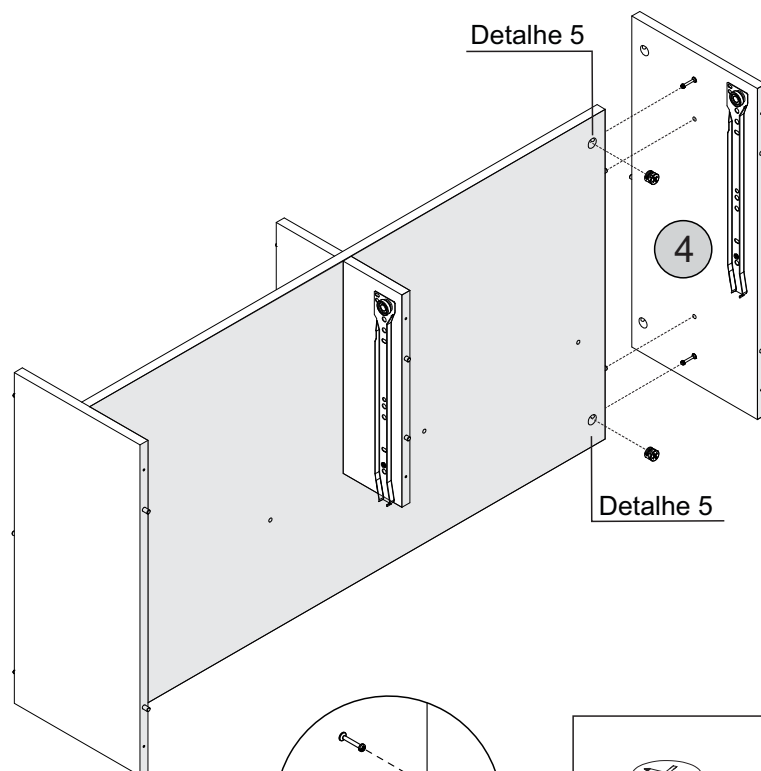
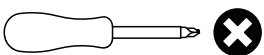

Detalhe 5
Detail/Detalle

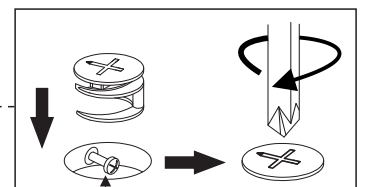

Cabeça do parafuso precisa estar no centro
La cabeza del tornillo debe estar en el centro
Screw head has to be in the center

Passo 11

Paso/Step

PEÇA
Piece/Pieza

1 - TAMPO x1

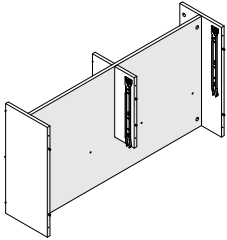

FERRAGEM
Hardware/Herraje

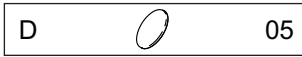
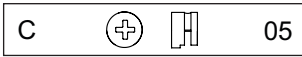

FERRAMENTA
Tool/Herramienta

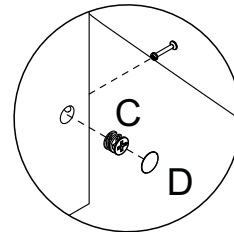
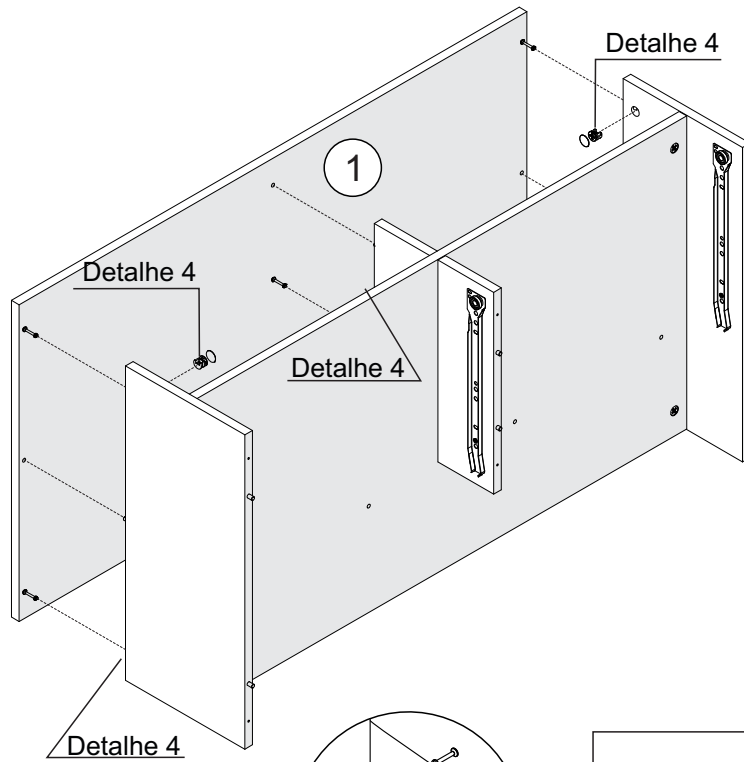
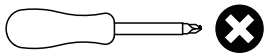

Detalhe 4
Detail/Detalle

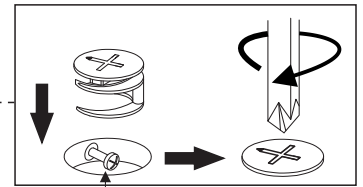

Cabeça do parafuso precisa estar no centro
La cabeza del tornillo debe estar en el centro
Screw head has to be in the center

Passo 12

Paso/Step

PEÇA
Piece/Pieza

8 - TRASEIRA x1

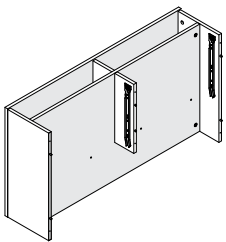

FERRAGEM
Hardware/Herraje

FERRAMENTA
Tool/Herramienta

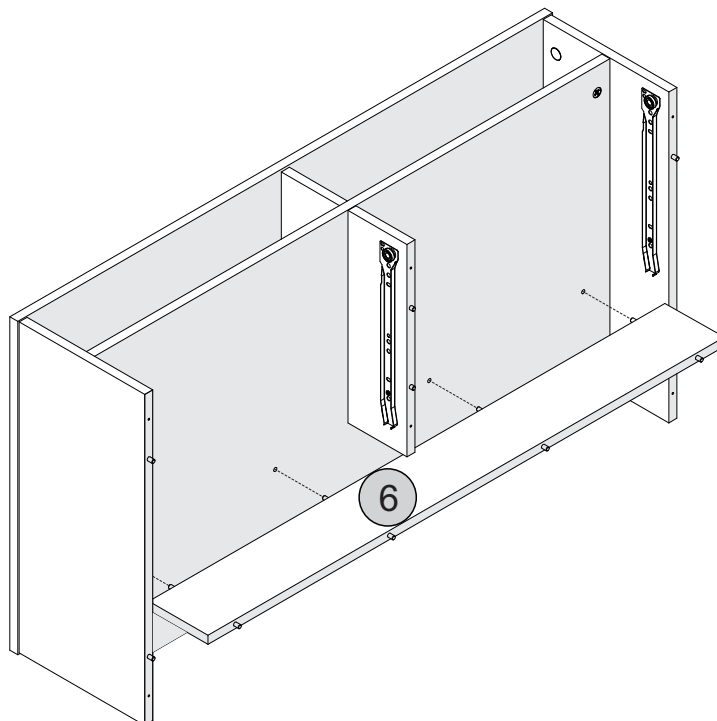

Passo 11

Paso/Step

PEÇA
Piece/Pieza

2 - BASE x1

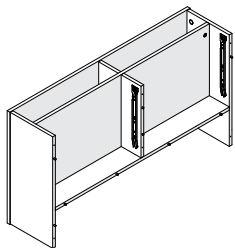

FERRAGEM
Hardware/Herraje

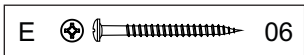

FERRAMENTA
Tool/Herramienta

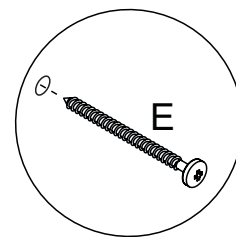
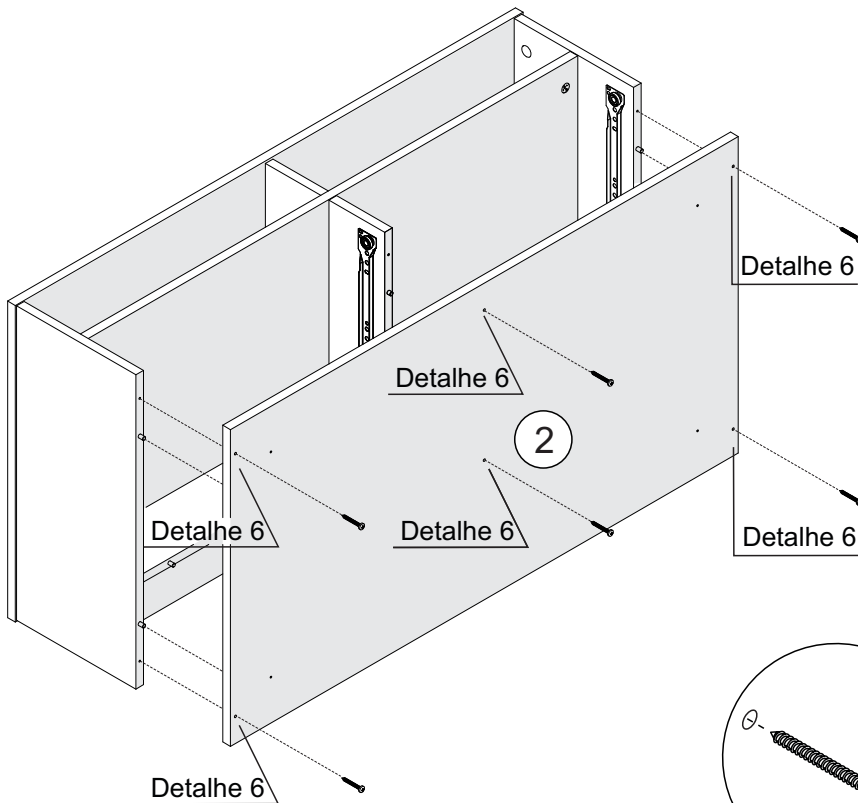
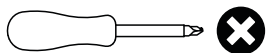

Detalhe 6
Detail/Detalle

Passo 12

Paso/Step

PEÇA
Piece/Pieza

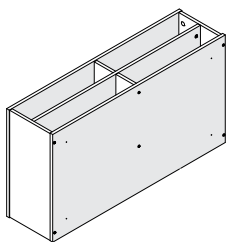

FERRAGEM
Hardware/Herraje

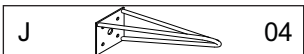

FERRAMENTA
Tool/Herramienta

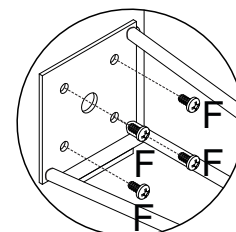
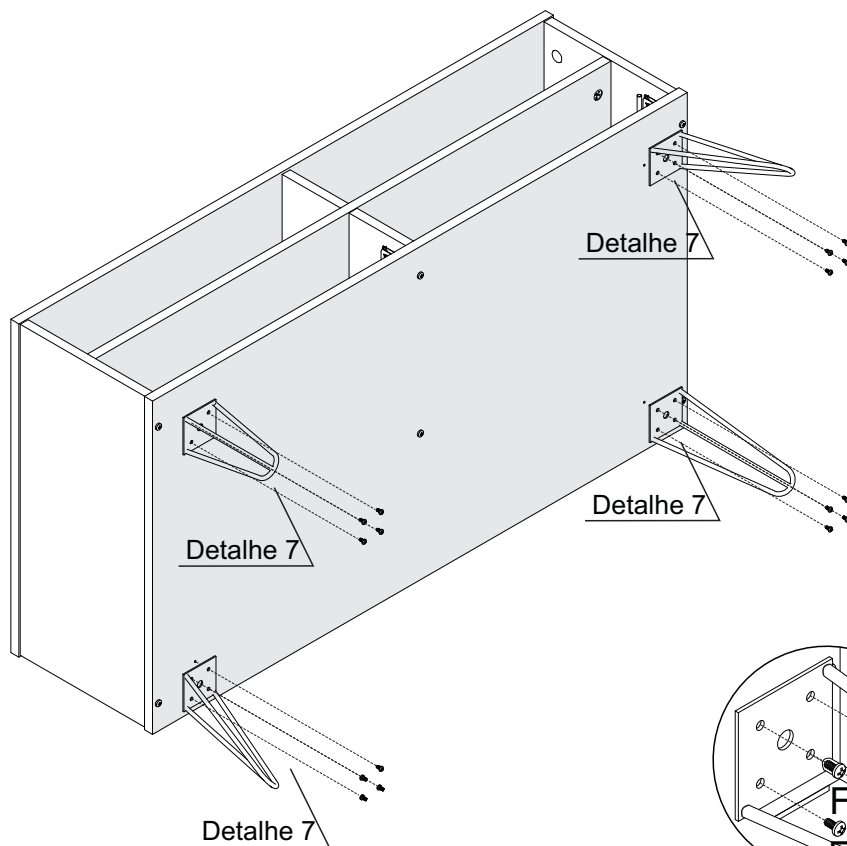
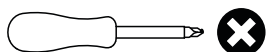

Detalhe 7
Detail/Detalle

Passo 15

Paso/Step

PEÇA Piece/Pieza

09 - FRENTE GAVETA x2

10 - TRASEIRA GAVETA x2

11 - LATERAL GAVETA x4

FERRAGEM Hardware/Herraje

A  08

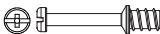
B  08

FERRAMENTA Tool/Herramienta

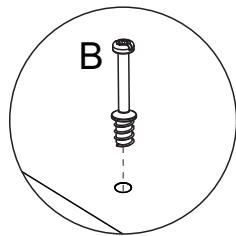
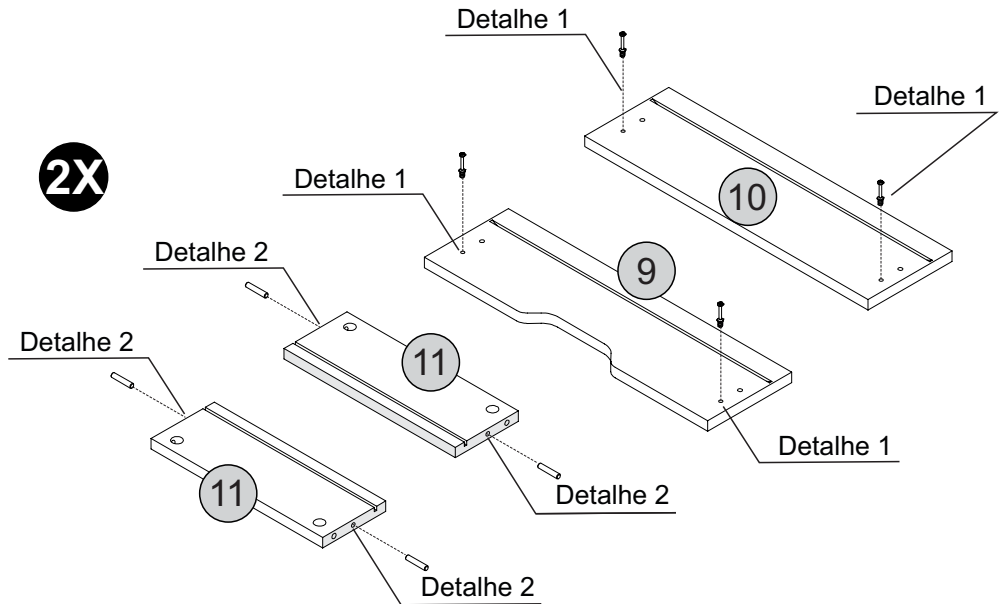
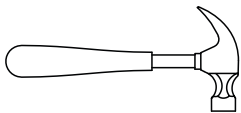
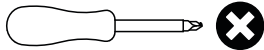

Detalhe 1
Detail/Detalle

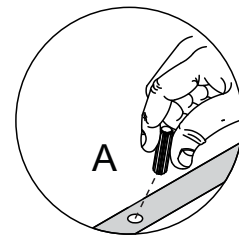
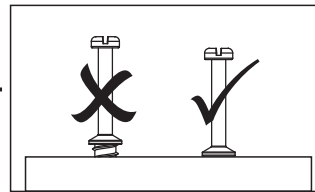

Detalhe 2
Detail/Detalle

Passo 16

Paso/Step

PEÇA Piece/Pieza

9 - FRENTE GAVETA x2

11 - LATERAL GAVETA x4

12 - FUNDO GAVETA x2

FERRAGEM Hardware/Herraje

C  04

D  04

FERRAMENTA Tool/Herramienta

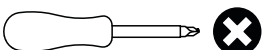

2X

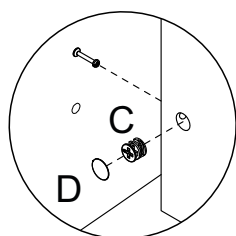
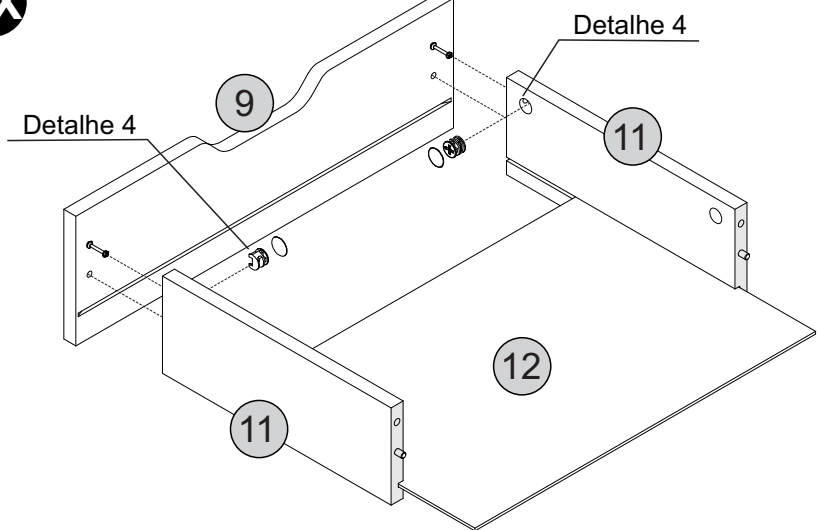

Detalhe 4
Detail/Detalle

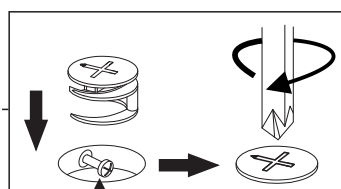

Cabeça do parafuso precisa estar no centro
La cabeza del tornillo debe estar en el centro
Screw head has to be in the center

Passo 17

Paso/Step

PEÇA
Piece/Pieza

10 - TRASEIRA GAVETA x2

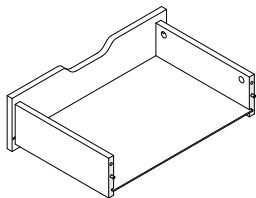

FERRAGEM
Hardware/Herraje

C 04

D 04

FERRAMENTA
Tool/Herramienta

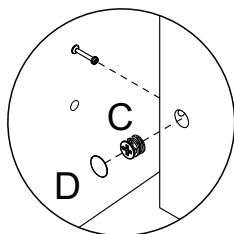
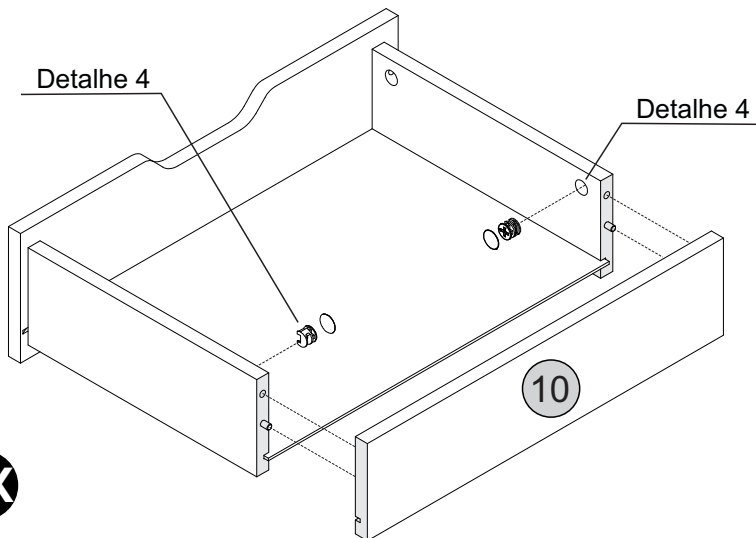
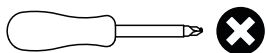

Detalhe 4
Detail/Detalle

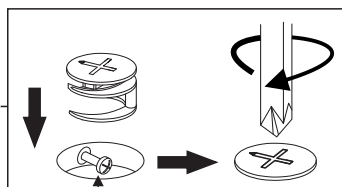

Cabeça do parafuso precisa estar no centro
La cabeza del tornillo debe estar en el centro
Screw head has to be in the center

Passo 18

Paso/Step

PEÇA
Piece/Pieza

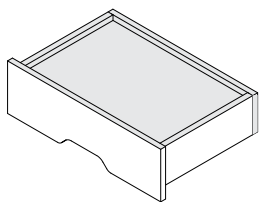

FERRAGEM
Hardware/Herraje

G 08

K 04

FERRAMENTA
Tool/Herramienta

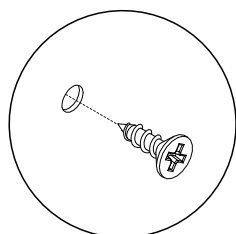
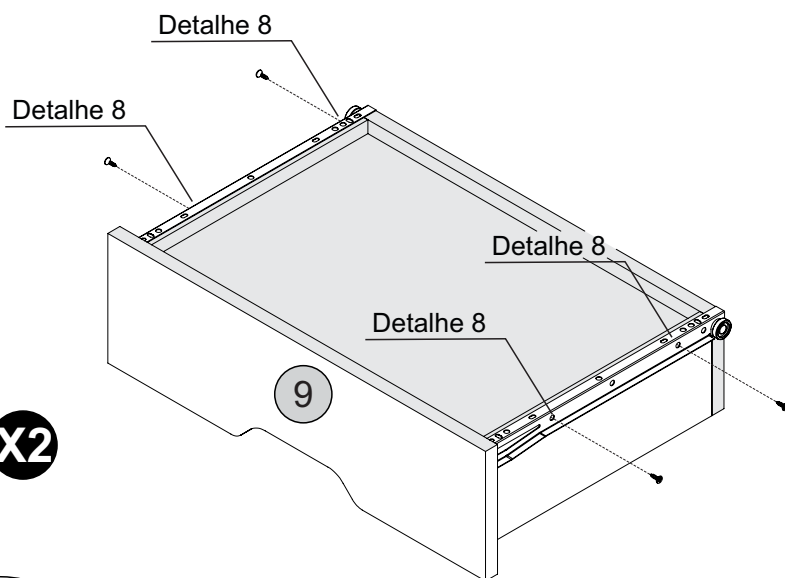
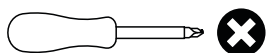

Detalhe 8
Detail/Detalle

Passo 19

Paso/Step

PEÇA
Pieça/Pieza

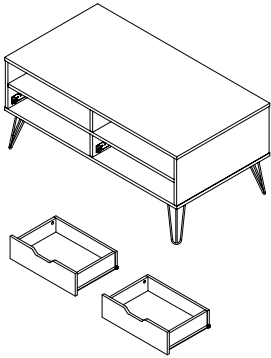

FERRAGEM
Hardware/Herraje

FERRAMENTA
Tool/Herramienta

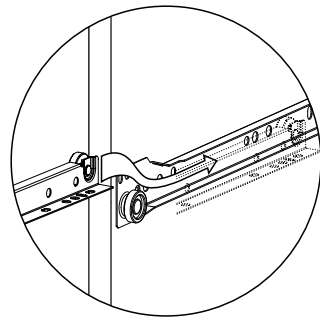
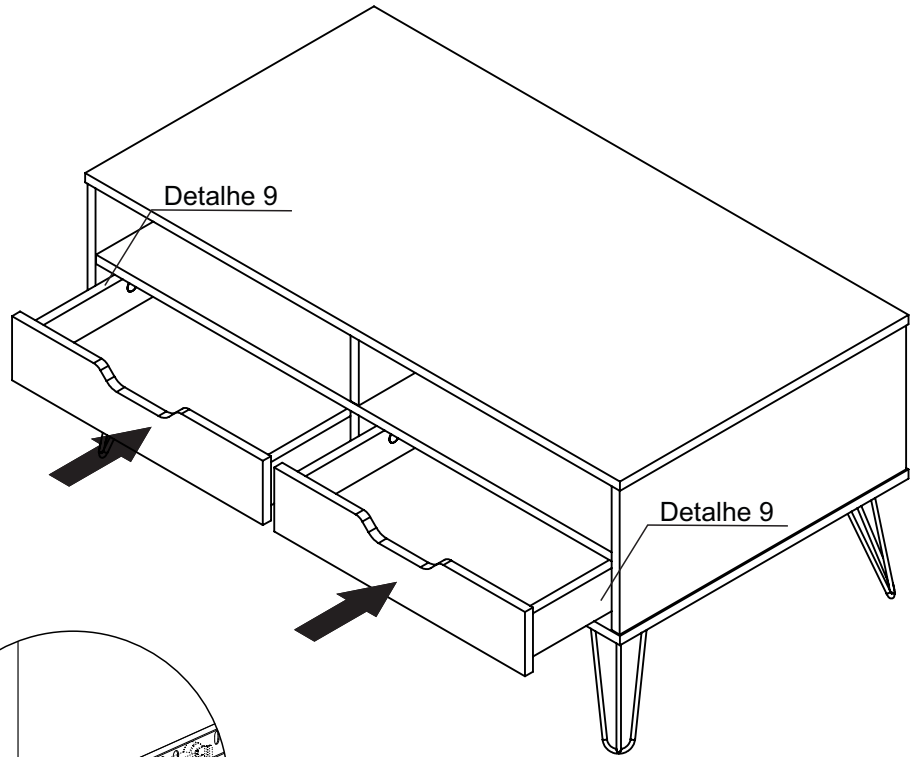

Detalhe 9
Detail/Detalle

Passo 20

Paso/Step

PEÇA
Pieça/Pieza

FERRAGEM
Hardware/Herraje

FERRAMENTA
Tool/Herramienta



- O número na borda da peça corresponde ao manual.
- Para retirada do número usar Lustra-Móveis, Alcool em Gel ou Borracha.
- El número en el borde de la pieza coincide con el manual.
- Use una goma de borrar blanca, alcohol en gel o lustrador para muebles para eliminar los números.
- The number on the edge of the piece matches the manual.
- Use a White eraser, Alcohol Gel or Furniture Polish to remove the numbers.

