



mxmóveis

Rodovia SC-492 - Km 10 - B. Industrial

89905-000 - Bandeirante - SC

Fone: (49) 3622-4549

e-mail: mxmoveis@mxmoveis.com.br

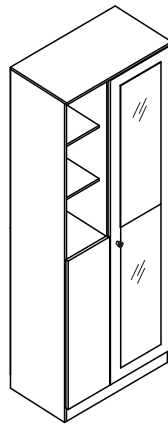

Ref. MU001

Sapateira

Mueble para zapato

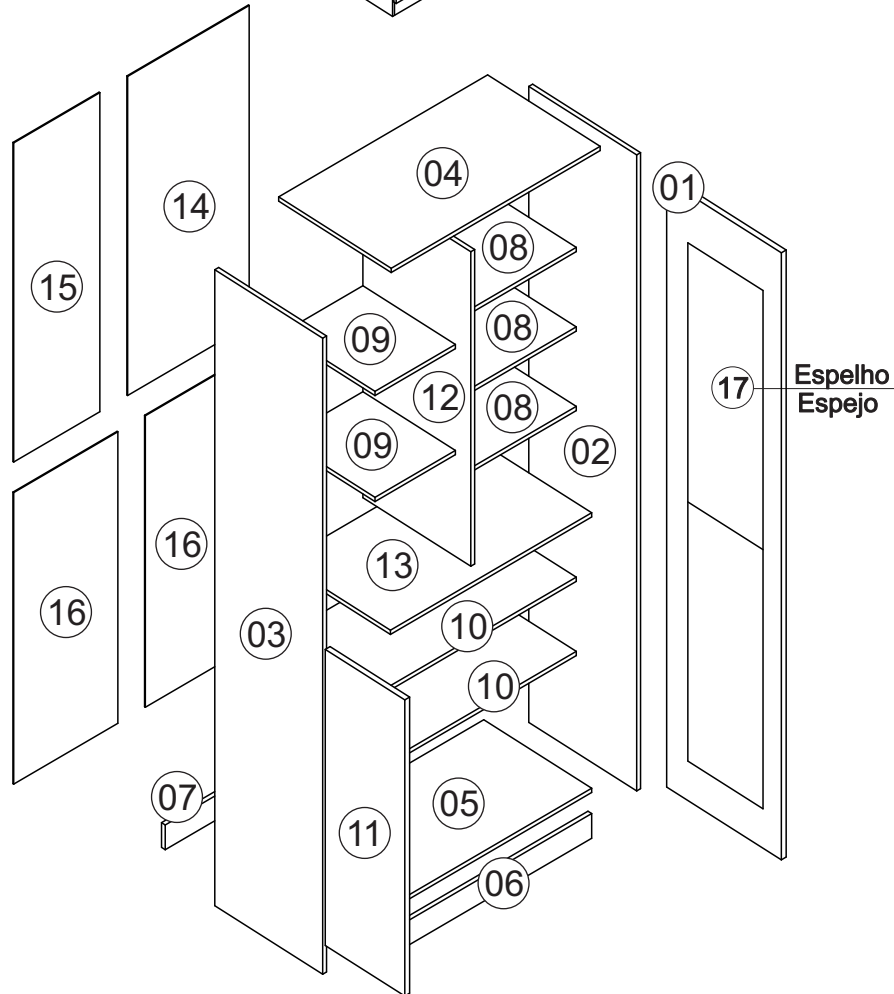

Nº	CÓDIGO ASSISTÊNCIA	NOME DA PEÇA/DESCRIPCIÓN PIEZAS	MEDIDAS (mm)	QTD.	CÓDIGO DAS PEÇAS/CÓDIGO PIEZAS				
					HAVANA/ HAVANA RIP.	TERRANO/ TERRANO RIP.	MARROCOS	BRANCO	NOGAL
01	MU001.25.00	Porta/Puerta	1722x373x15	01	54306	54295	189468	54229	154093
02	MU001.17.00	Lateral externa direita/Lateral derecha	1800x350x12	01	152383	54638	189469	54501	154094
03	MU001.18.00	Lateral externa esquerda/Lateral izquierda	1800x350x12	01	152384	58761	189470	58755	154095
04	MU001.05.00	Base superior/Base superior	650x365x12	01	168824	168823	189472	168822	168828
05	MU001.01.00	Base inferior/Base inferior	626x350x12	01	54511	54496	189473	54504	154098
06	MU001.30.02	Rodapé frontal/Zócalo delantero	626x70x12	01	54312	49370	189474	54235	154099
07	MU001.32.00	Rodapé traseiro/Zócalo de atrás	626x70x12	01	45477	45477	45477	45477	45477
08	MU001.27.02	Prateleira/Repisa	364x300x12	03	54497	54497	54497	54497	54497
09	MU001.27.01	Prateleira/Repisa	250x300x12	02	58763	58759	189475	58756	154100
10	MU001.27.00	Prateleira/Repisa	626x300x12	02	54498	54498	54498	54498	54498
11	MU001.25.01	Porta/Puerta	840x260x15	01	54305	54294	189467	54228	154092
12	MU001.19.00	Lateral interna/Divisoria	890x350x12	01	54509	54494	189471	54502	154096
13	MU001.02.01	Base central/Base del medio	626x350x12	01	58764	58760	189476	58757	154101
14	MU001.13.00	Forro/Revés	903x378x2,5	01	51000	51000	51000	51000	51000
15	MU001.13.02	Forro/Revés	903x268x2,5	01	60777	60763	189477	60743	154102
16	MU001.13.01	Forro/Revés	830x323x2,5	02	51002	51002	51002	51002	51002
17	1636	Espelho/Espejo	800x250	02	-	-	-	-	-

Ferragens/Herrajes

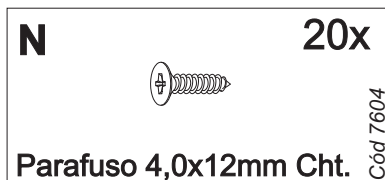
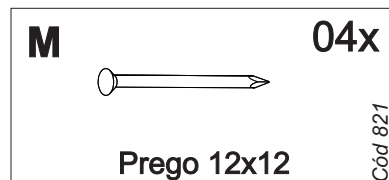
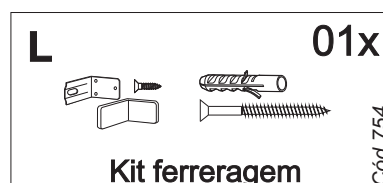
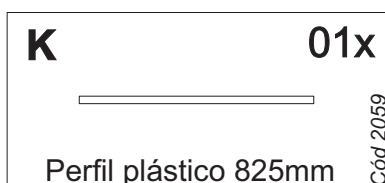
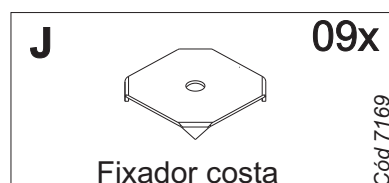
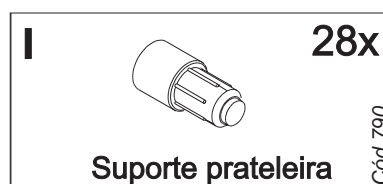
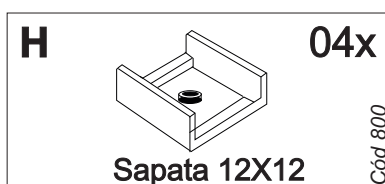
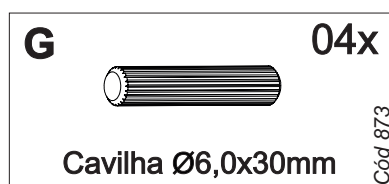
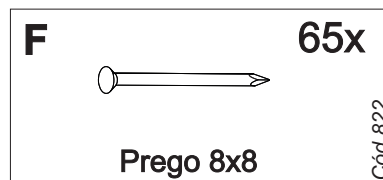
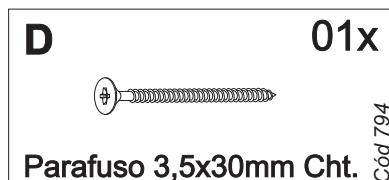
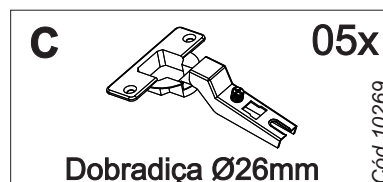
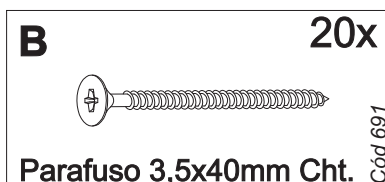

Medidas em mm

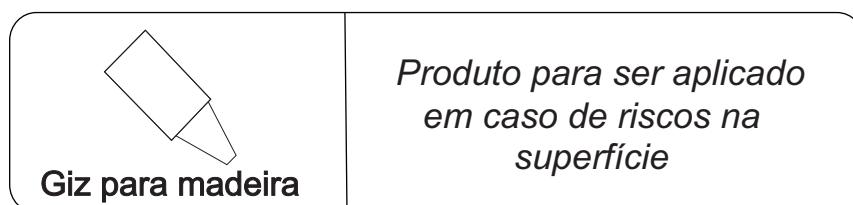
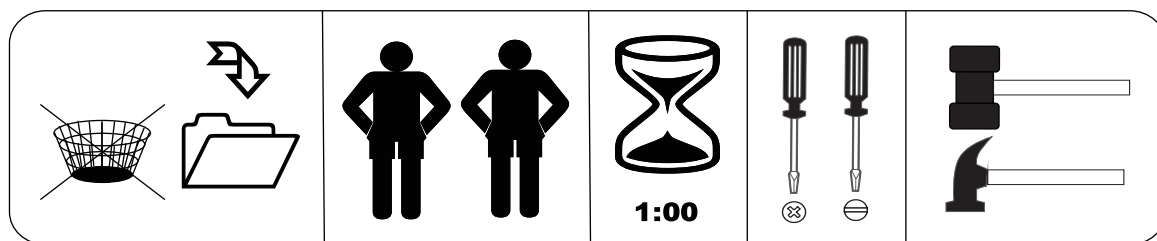

Pré-Montagem/Preparación Piezas

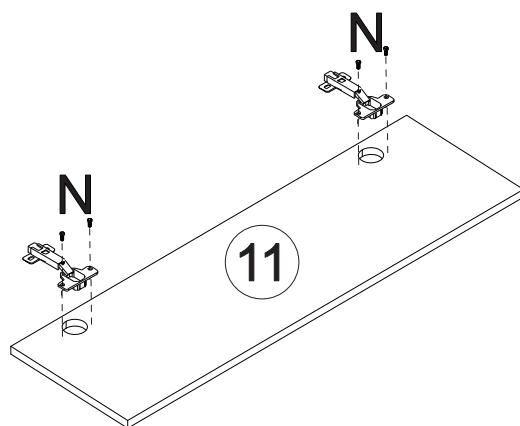
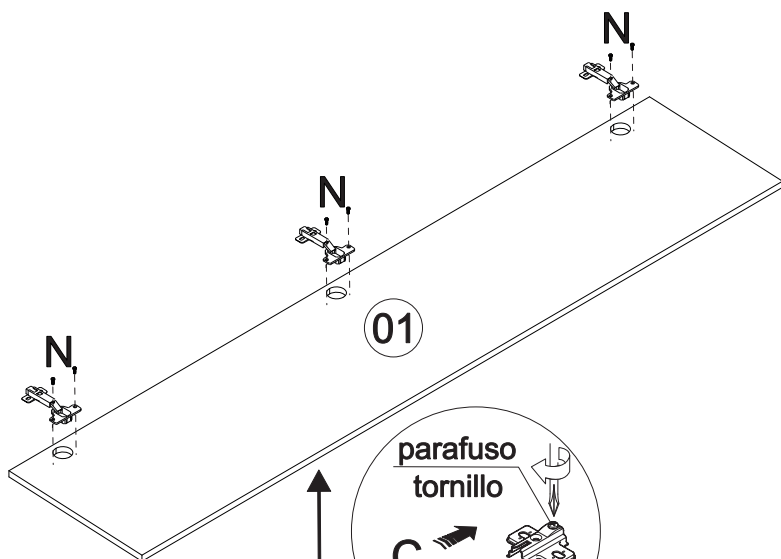

***Usar uma proteção no chão para não danificar o espelho utilizar una protección en el suelo para no dañar el espejo**

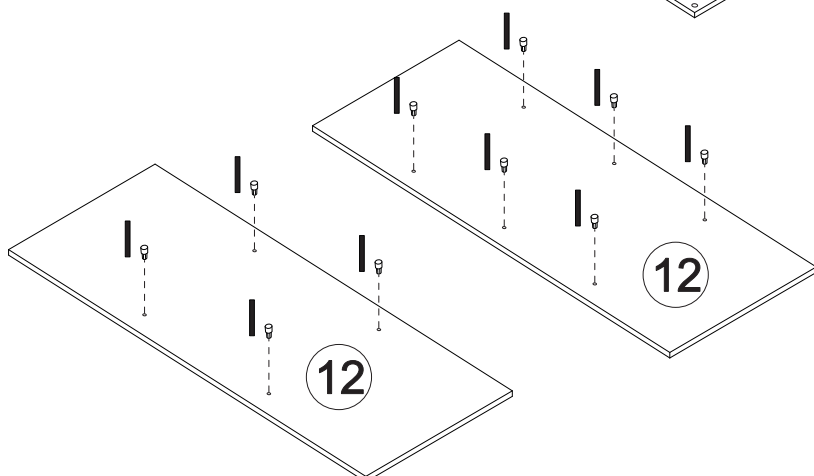
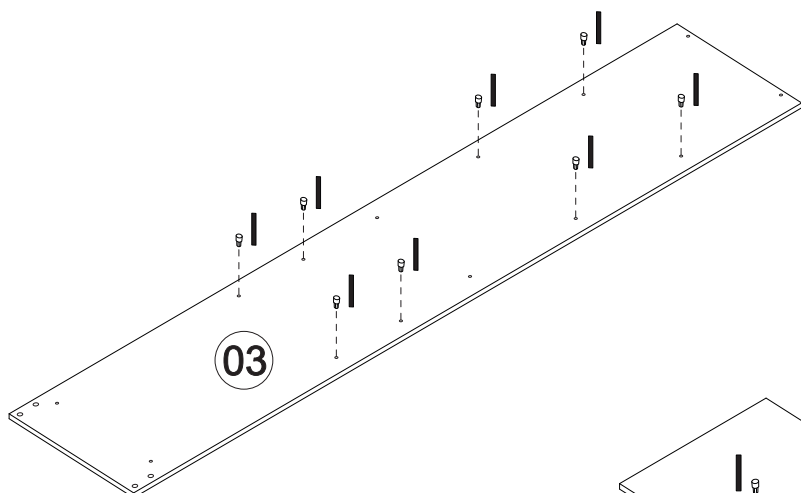
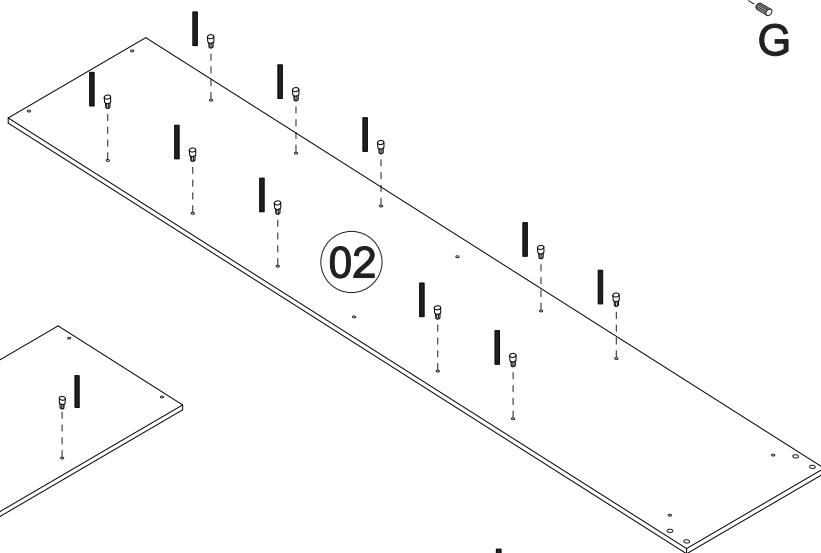
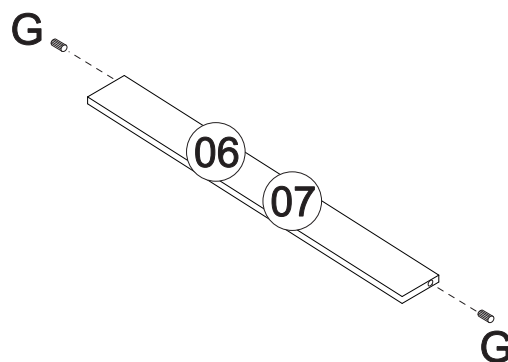

Montagem/Montaje

01

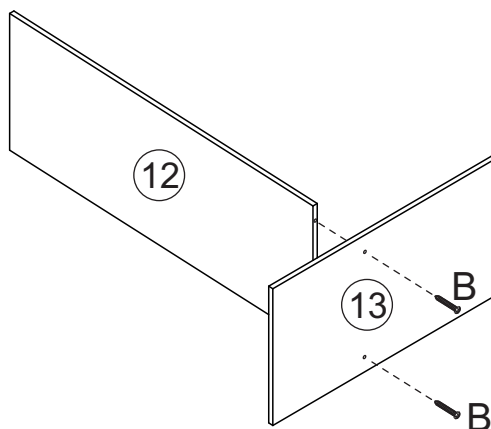

02

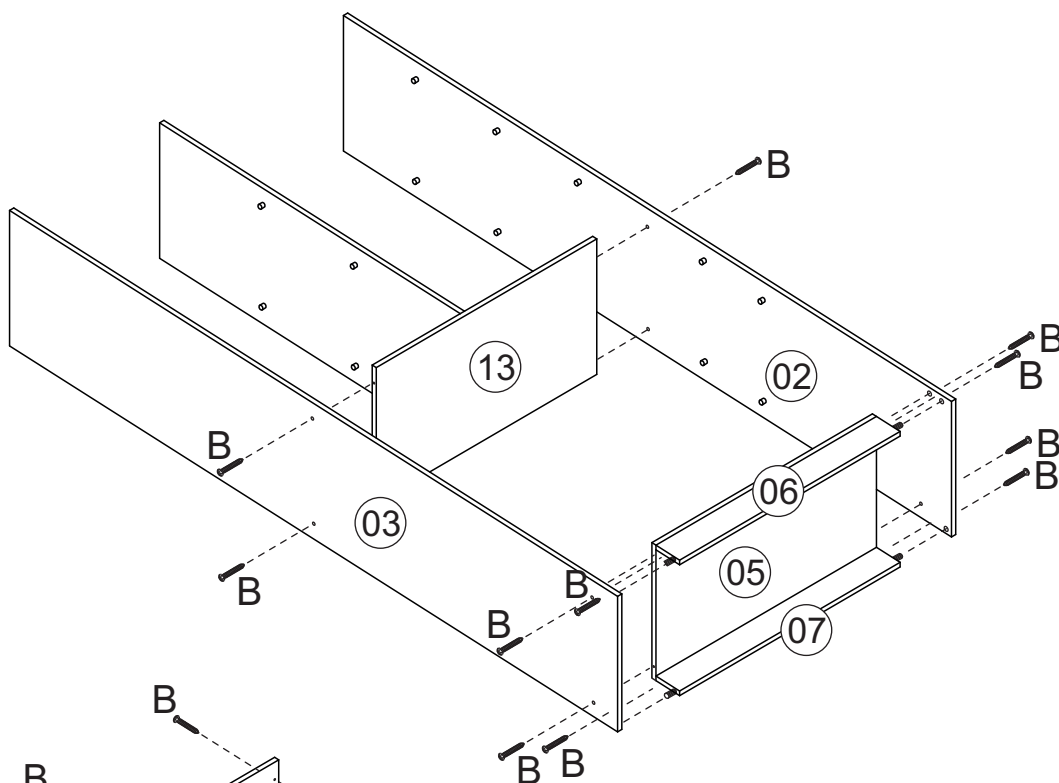

03

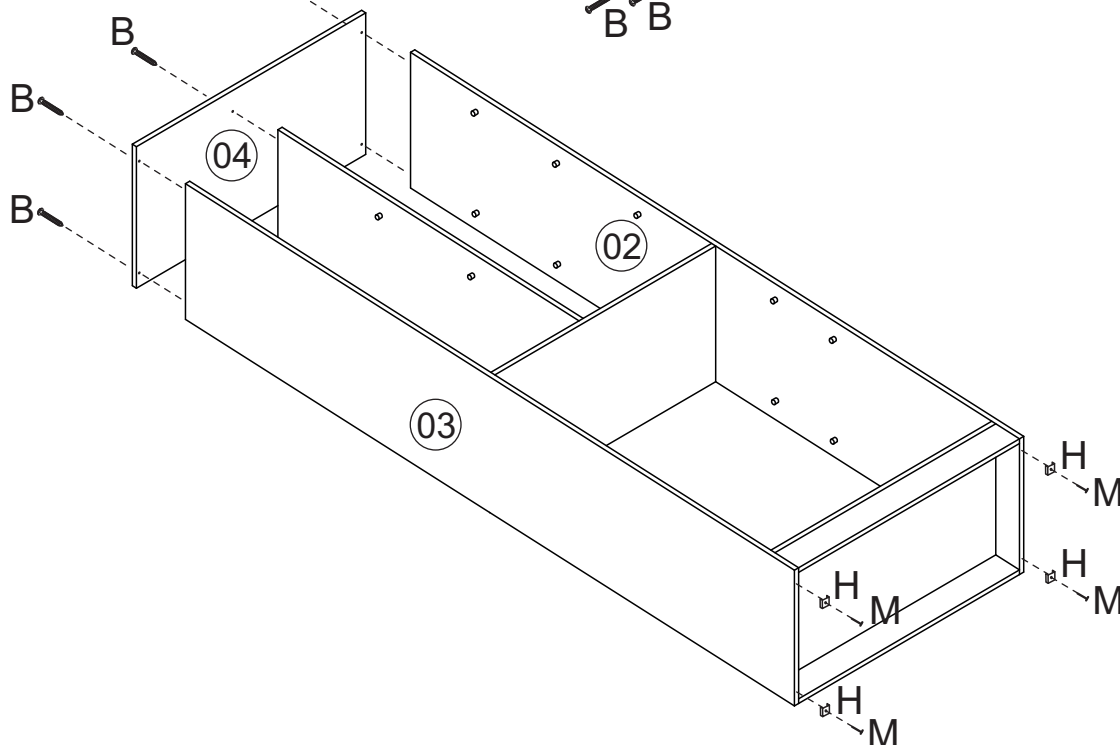

Montagem/Montaje

04

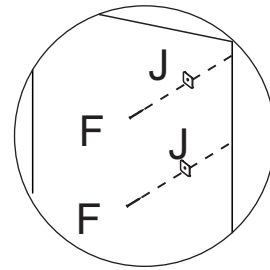
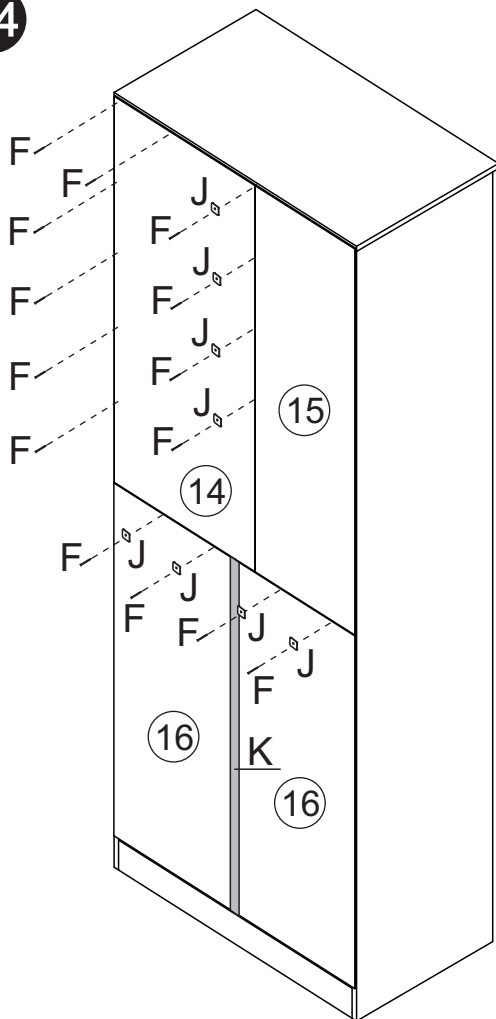

*Usar o prego (F) e a junção (J) a cada 150mm.

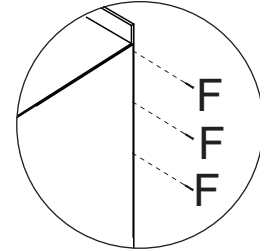

*Colocar um prego (F) a cada 100mm.

05

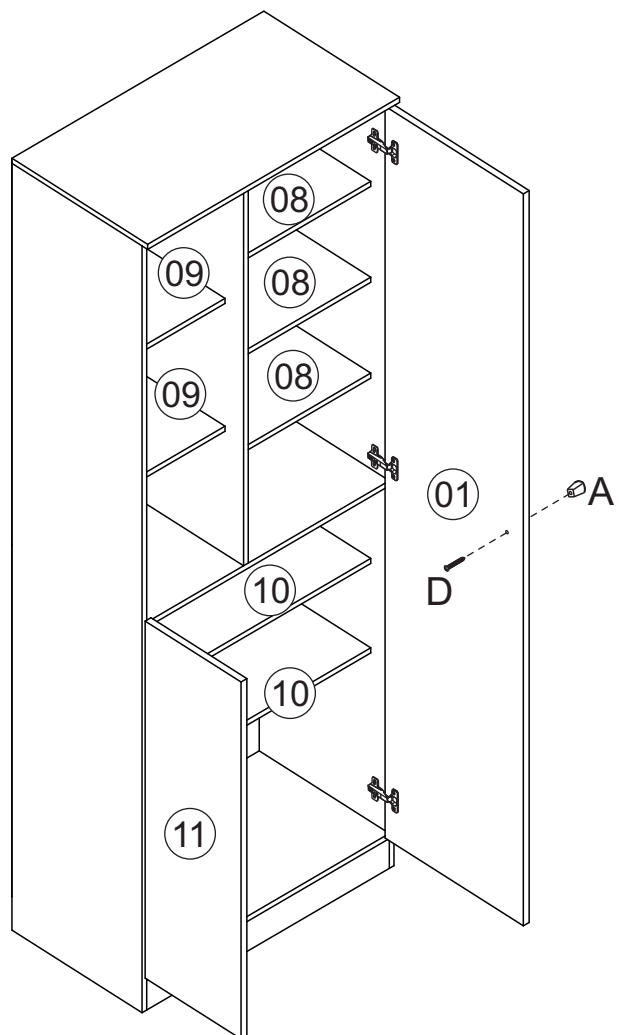
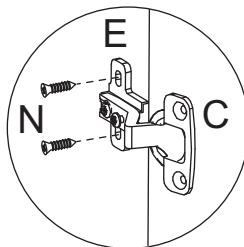

Fixação na parede
Fijación en la pared

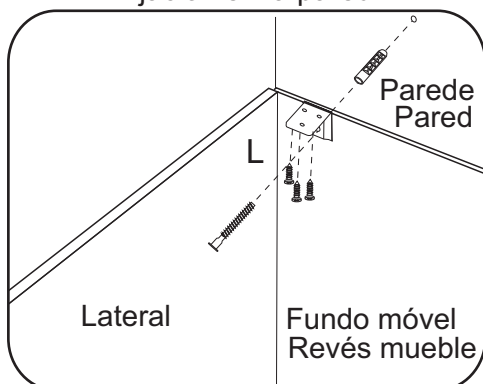

*Fixar a cantoneira na parte interna do móvel.
Fijar la pieza «L» en el interior del mueble.

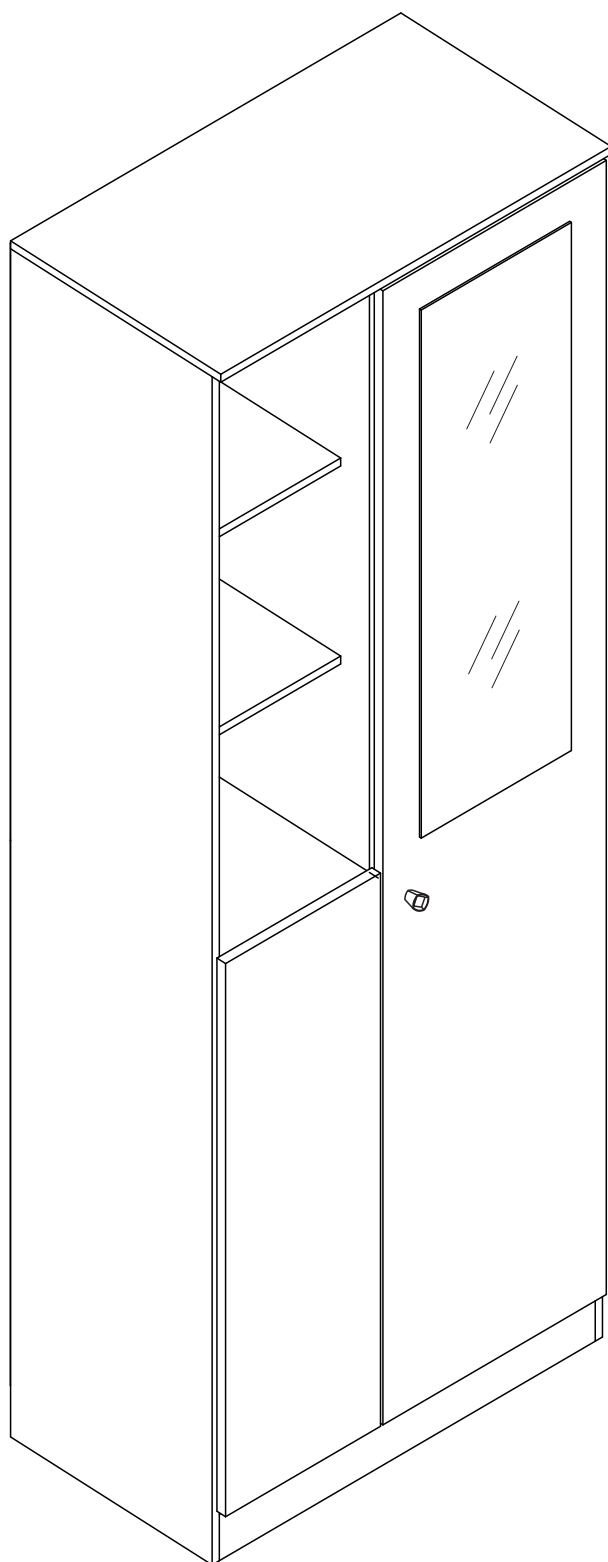

(VERIFICAR SE O ESPELHO ESTA BEM FIXADO, CASO FOR NECESSÁRIO, AJUSTAR O MESMO)

Limpeza/Limpieza

- ✘ Use um pano levemente umedecido com água, seguido de pano seco.
- ✘ *Use solamente un paño húmedo con agua y después un paño seco.*
- ✘ Nunca utilize produtos químicos ou abrasivos.
- ✘ *No utilice productos quimicos o abrasivos.*