

CO6401 TORRE QUENTE

Manual de Montagem
 Assembly Instructions
 Instrucción de Montaje

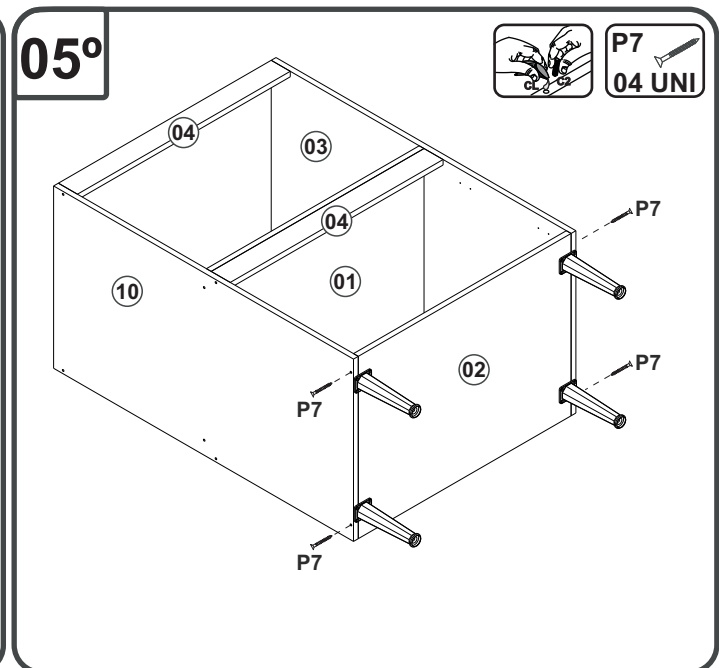
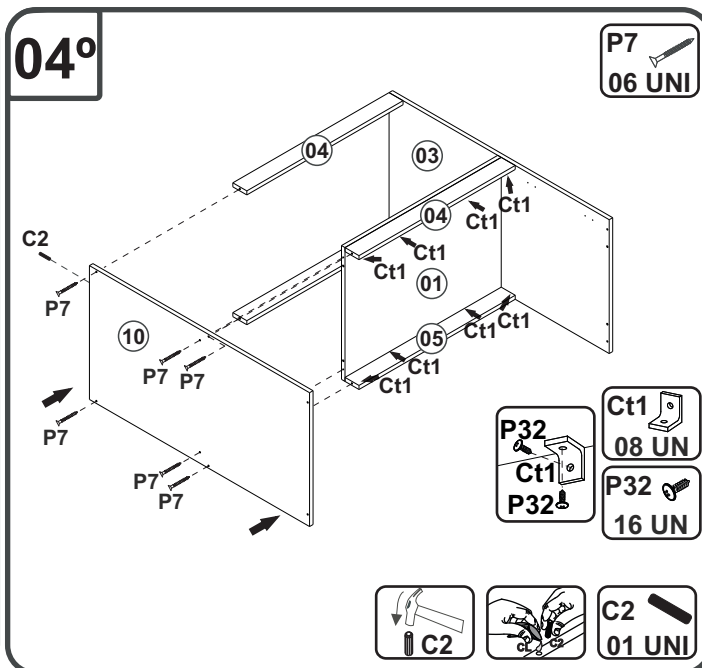
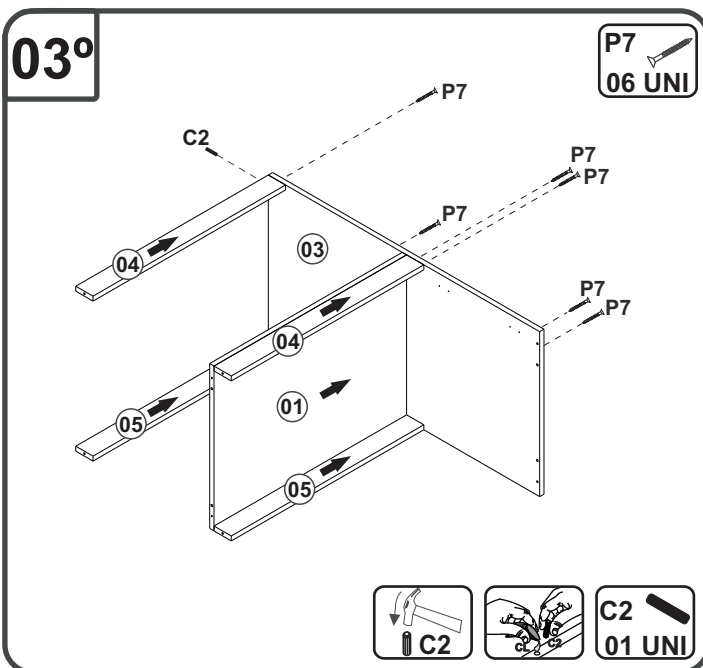
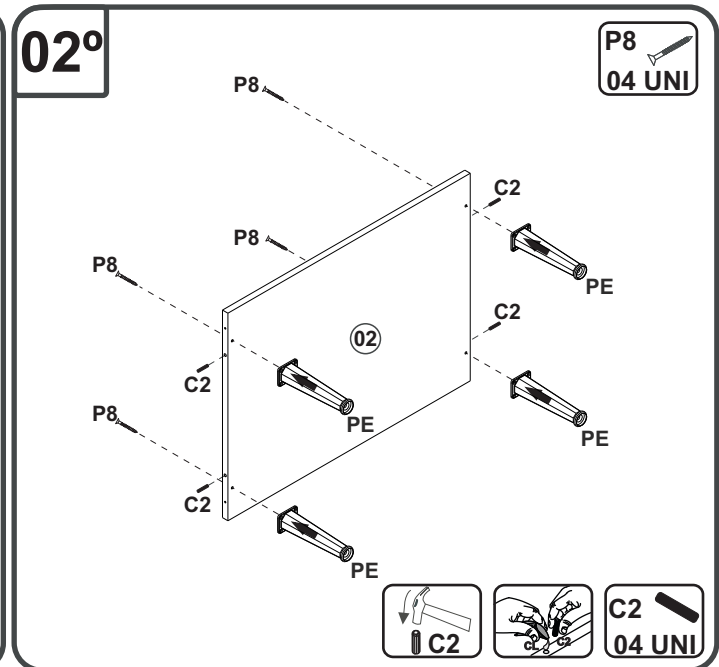
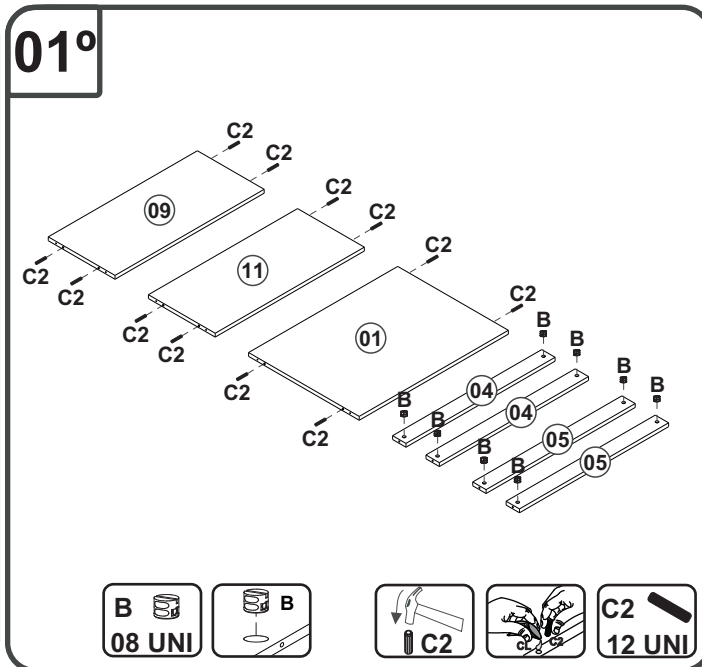
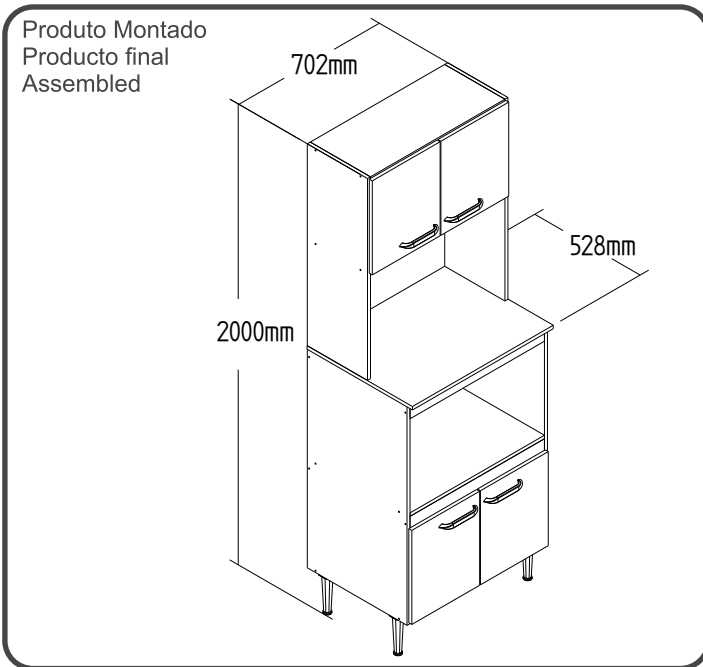

CO6401 TORRE QUENTE

Manual de Montagem
Assembly Instructions
Instrucción de Montaje

decibal[®]
móveis

10°



PESO SUPORTADO/PESO SOPORTADO/ WEIGHT SUPPORTED

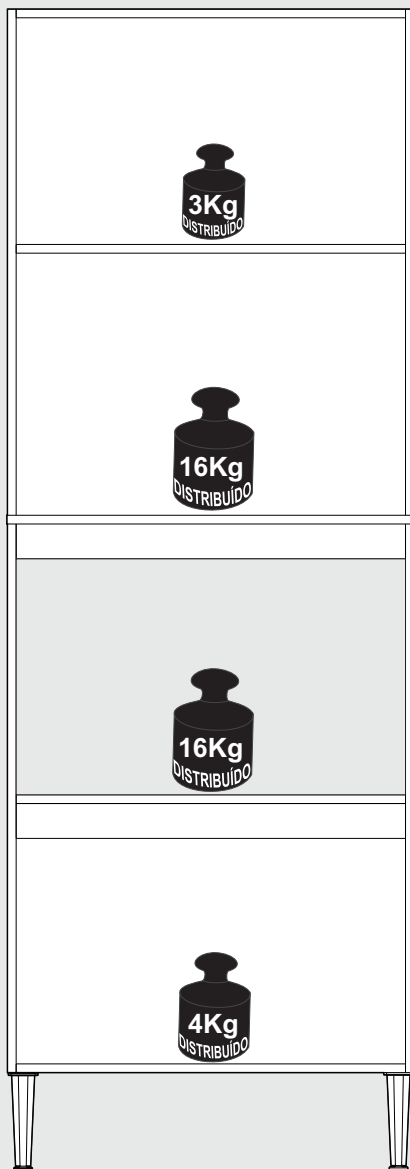

11°

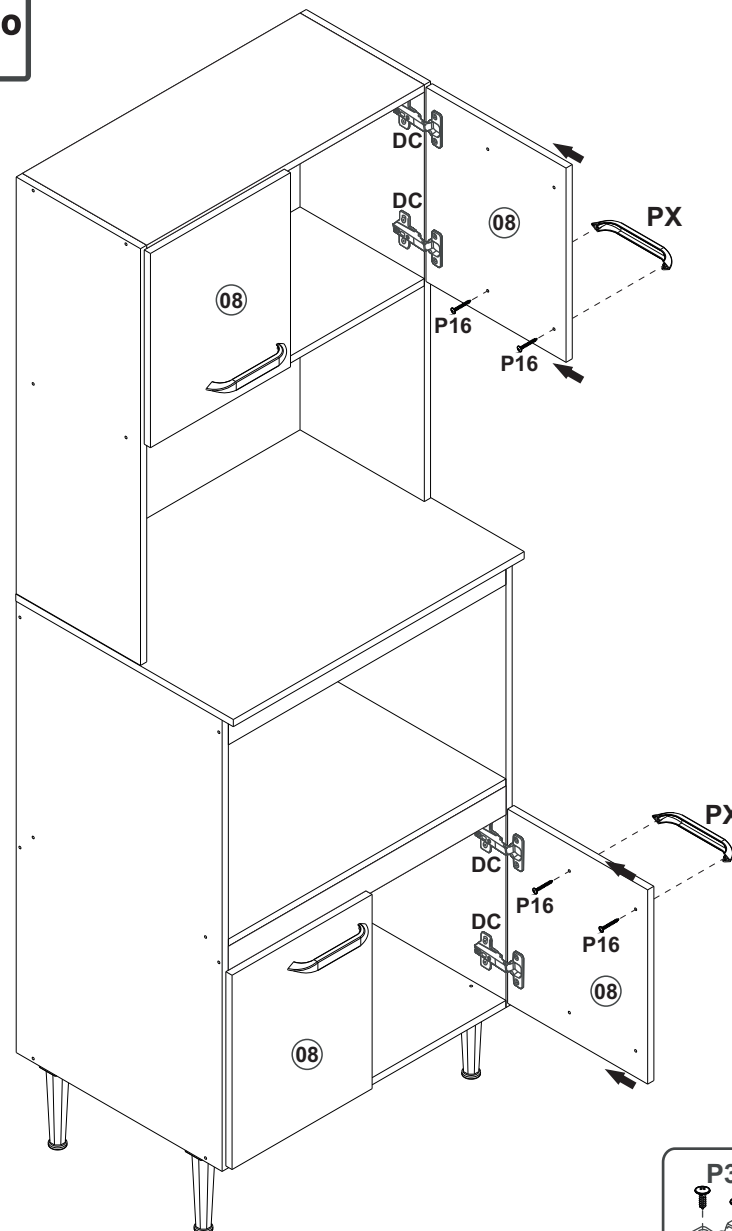

P32
32 UNI

P16
08 UNI

PX
04 UNI

DC
08 UNI

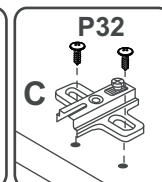
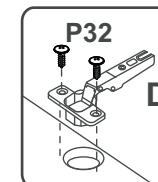
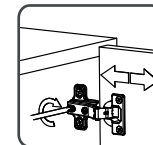
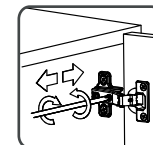
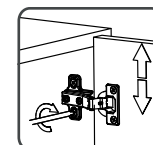

D C
DOBRADIÇA/BISAGRA/HINGE D=26mm C=5

CO6401 TORRE QUENTE

Manual de Montagem
Assembly Instructions
Instrucción de Montaje

decibal[®]
móveis

Relação de Peças/ Relación de Piezas/Parts List

N°	CÓDIGO/CODE	DESCRIÇÃO/DESCRIPCIÓN/DESCRIPTION	QTD/CANT	VOL.
1	0569863	BASE MEIO	670X497X15MM	1
2	0569855	BASE INF	670X497X15MM	1
3	0569860	LATERAL DIR INF/LATERAL/SIDE	944X497X15MM	1
4	0569867	TRAVESSA FRT/TRAVIESSA/TRVERSE	670X60X15MM	2
5	0569868	TRAVESSA TRS/TRAVIESSA/TRVERSE	670X60X15MM	2
6	0569862	LATERAL ESQ SUP/LATERAL/SIDE	871X300X15MM	1
7	0569858	LATERAL DIR SUP/LATERAL/SIDE	871X300X15MM	1
8	0569866	PORTA/PUERTA/DOOR	406X338X15MM	4
9	0569859	TAMPO SUP/TAPA/TOP	670X300X15MM	1
10	0569861	LATERAL ESQ INF/LATERAL/SIDE	944X497X15MM	1
11	0569864	BASE SUP	670X300X15MM	1
12	0569865	TAMPO/TAPA/TOP	702X525X15MM	1
13	0569856	COSTA MAIOR/REVÉS/BACK	694X472X2, 8MM	1
14	0569857	COSTA MENOR/REVÉS/BACK	694X407X2, 8MM	1
15	0569968	COSTA INF/REVÉS/BACK	694X415X2, 8MM	1

Escala (1:1)

LEGENDA	DESCRIÇÃO/DESCRIPCIÓN/DESCRIPTION	CÓDIGO	QUANT.
PU	 PARAFUSO UNIÃO/UNIÓN DETORNILLO /SCREW UNION	01495	02
B	 BUCHA/BUJE/BUCHING	02734	08

ATENÇÃO!!!! montadores e consumidores
* Ajustar o torque da parafusadeira para não danificar as peças escareando o parafuso *

ATENCIÓN!!!! montadores e consumidores
* Ajuste el torque del destornillador para no dañar las piezas avallanando el tornillo *

ATTENTION!!!! assemblers and consumers
* Adjust the torque of the screwdriver so as not to damage the parts by countersinking the screw *

ATENÇÃO!!!! montadores e consumidores

* Para limpar o móveis utilize somente um pano úmido (umedecido em água pura ou água com sabão neutro). Depois, passe um pano seco. Evite a umidade excessiva.
* Evite usar álcool, água sanitária, detergente e outros produtos químicos, mesmo diluídos em água.
* Não utilize produtos abrasivos de nenhuma espécie

ATENCIÓN!!!! montadores e consumidores

* Para limpiar el mueble utilice solamente un paño húmedo (humedecido con agua limpia o con un jabón suave). A continuación, utilice un paño seco. Evite el exceso de humedad.
* Evite uso de alcohol, hipoclorido solución basada, detergente y otros productos químicos, mismo diluídos en agua.
No utilice productos abrasivos de ningún tipo.

ATTENTION!!!! assemblers and consumers

* To clean the furniture, use only a damp cloth (humidify it only in pure water ou water and neutral soap). After, use a dry cloth. Avoid excessive humidity.
* Avoid using alcohol, bleach, detergent and other chemical products, even diluted in water. Do not use any kind of abrasive cleaning agents to clean the furniture.
The use of such products may jeopardize the ?nal characteristics of the furniture.

www.decibal.com.br

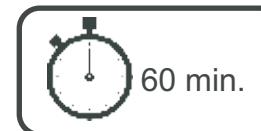

60 min.



2 montador
2 ajustador
2 Fitter

Ferramentas necessárias
Necessary tools
Herramientas necesarias

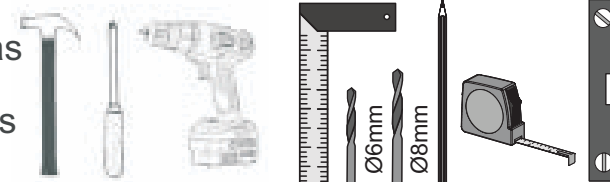









CO6401 TORRE QUENTE







Manual de Montagem
Assembly Instructions
Instrucción de Montaje



Escala (1:1)

LEGENDA	DESCRIÇÃO/DESCRIPCIÓN/DESCRIPTION	CÓDIGO	QUANT.
P1	 PARAFUSO/TORNILLO/SCREW 3,5X12	01328	06
P7	 PARAFUSO/TORNILLO/SCREW 4X45	01318	28
P8	 PARAFUSO/TORNILLO/SCREW 5X45	01320	04
P9	 PARAFUSO/TORNILLO/SCREW 6X50	03827	02
P16	 PARAFUSO/TORNILLO/SCREW 3,5X25	09955	08
P32	 PARAFUSO/TORNILLO/SCREW 4X14	12412	84
C2	 CAVILHA/TARUGO/DOWEL 6X30 MM	01211	20
C3	 CAVILHA/TARUGO/DOWEL 6X50 MM	01212	04
Pr1	 PREGO/CLAVO/NAIL 10X10	01330	55

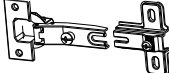
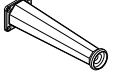
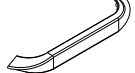
Escala (N/A)

LEGENDA	DESCRIÇÃO/DESCRIPCIÓN/DESCRIPTION	CÓDIGO	QUANT.
CL	 COLA/PEGAMENTO/GLUE	01213	01
ET	 ETIQUETA LOGO DECIBAL/LABEL DECIBAL	01312	01
FX	 FIXADOR COSTA/FIJADOR FONDO/FIXER COAST	01331	06
AD	 ADESIVO/ADHESIVO/ADHESIVE	15mm	24
Ct1	 CANTONEIRA/PIEZA L/SHEET	03077	24
DC	 DOBRADIÇA/BISAGRA/HINGE D=26mm C=5mm	01268	08
PE	 PÉ/PATA/FOOT PE BRONZE CAFE 170 MM	13306	04
PX	 PUXADOR/PEGADOR /HANDLE PUX DUBAI 160MM CHAPAGNE ESCURO	13305	04
B8	 BUCHA/BUJE/BUCHING	01311	02
S5	 SUPORTE AÉREO/APOYO AÉREO/AIR SUPPORT	03828	02

Medida em mm

