

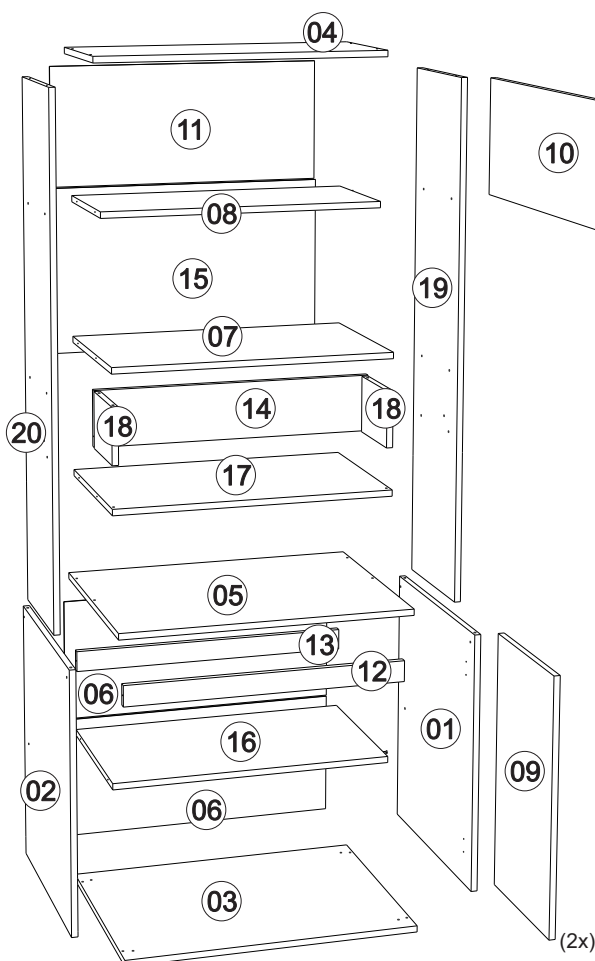

Rodovia SC-492 - Km 10 - B. Industrial
89905-000 - Bandeirante - SC
Fone: (49) 3622-4549
e-mail: mxmoveis@mxmoveis.com.br

Ref. TGL01

Torre quente 2 fornos
Cozinha/Cocina
GLORIA

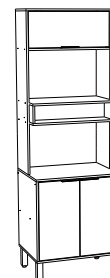

Nº	CÓDIGO ASSISTÊNCIA	NOME DA PEÇA/DESCRIPCIÓN PIEZAS	MEDIDAS (mm)	QTD.	CASTANHO OFF WHITE
01	TGL01.17.00	Lateral externa direita/Lateral derecha	625x516x15	01	263926
02	TGL01.18.00	Lateral externa esquerda/Lateral izquierda	625x516x15	01	263928
03	TGL01.01.00	Base inferior/Base inferior	700x516x15	01	263920
04	TGL01.05.00	Base superior/Base	700x300x15	01	263924
05	TGL01.33.00	Tampo/Tapa	700x516x22	01	263932
06	TGL01.13.01	Forro/Revés	686x412x2.5	02	263918
07	TGL01.02.02	Base micro/Base	670x400x15	01	263923
08	TGL01.01.01	Base inferior aéreo/Base inferior	670x300x15	01	263921
09	TGL01.25.00	Porta balcão/Puerta	615x329x15	01	260953
10	TGL01.25.01	Porta aéreo torre/Puerta	662x277x15	01	264015
11	TGL01.13.00	Forro/Revés	686x300x2.5	01	260938
12	TGL01.28.00	Ripa sustentação	670x50x15	01	263930
13	TGL01.28.01	Ripa sustentação	670x50x15	01	260956
14	TGL01.28.02	Ripa sustentação	670x135x15	01	263931
15	TGL01.13.02	Forro/Revés	686x297x2.5	01	260940
16	TGL01.02.00	Base interna/Base	670x387x15	01	261612
17	TGL01.02.01	Base interna/Base	670x400x15	01	263922
18	TGL01.38.00	Ripa de acabamento	209x135x15	01	263925
19	TGL01.17.01	Lateral externa dir	1265x300x15	01	263927
20	TGL01.18.01	Lateral externa esq	1265x300x15	01	263929

Ferragens/Herrajes

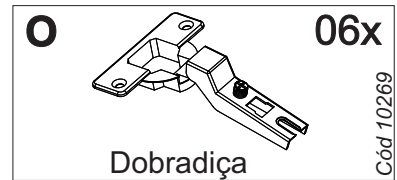
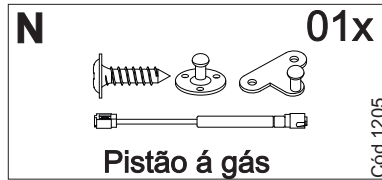
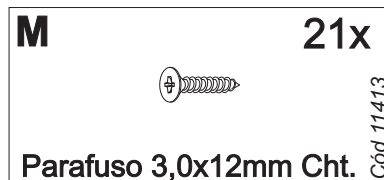
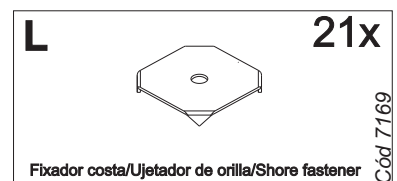
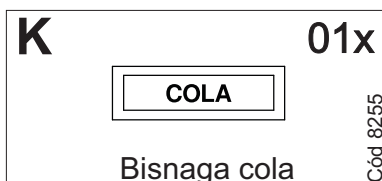
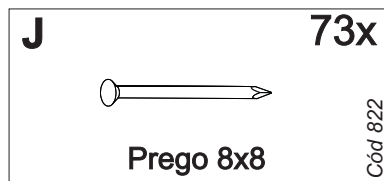
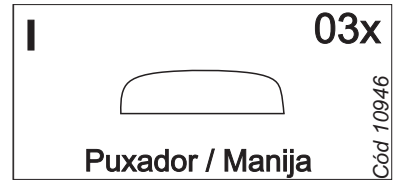
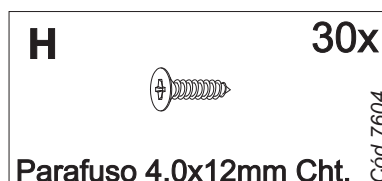
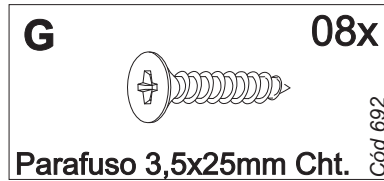
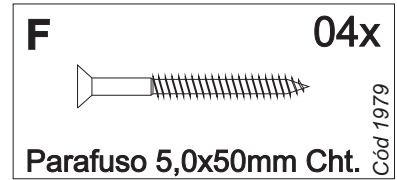
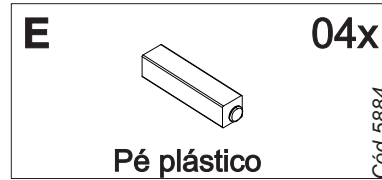
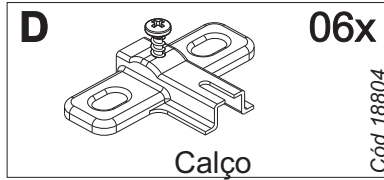
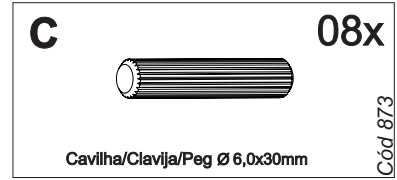
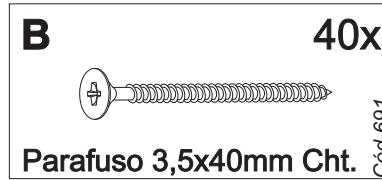

*Usar os parafusos (G) para unir este módulo a outro.
Usar los tornillos (G) para unirse este módulo a otro.

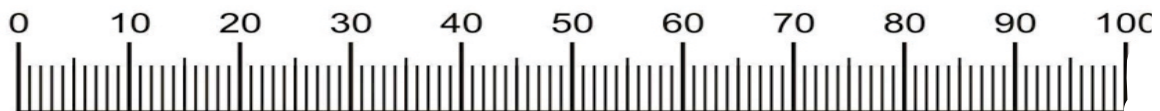

Medidas em mm
Measures in mm
Mesuras en mm

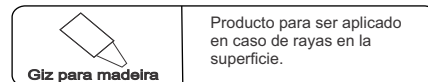
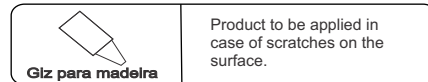
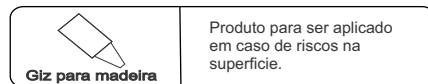
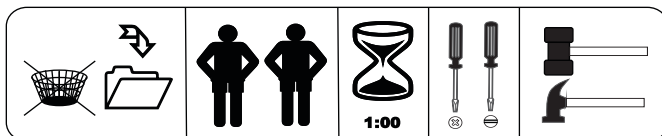

Limpeza/Limpieza

- ≠ Use um pano levemente umedecido com água, seguido de pano seco.
- ≠ Use solamente un paño húmedo con agua y después un paño seco.
- ≠ Nunca utilize produtos químicos ou abrasivos.
- ≠ No utilice productos químicos o abrasivos.

Pré-Montagem/Preparación Piezas

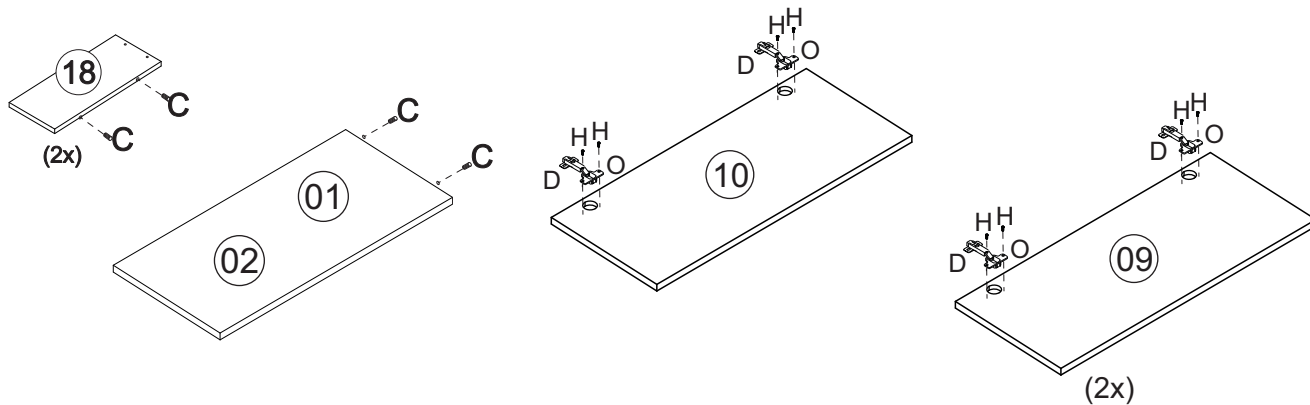

01 Montagem/Montaje

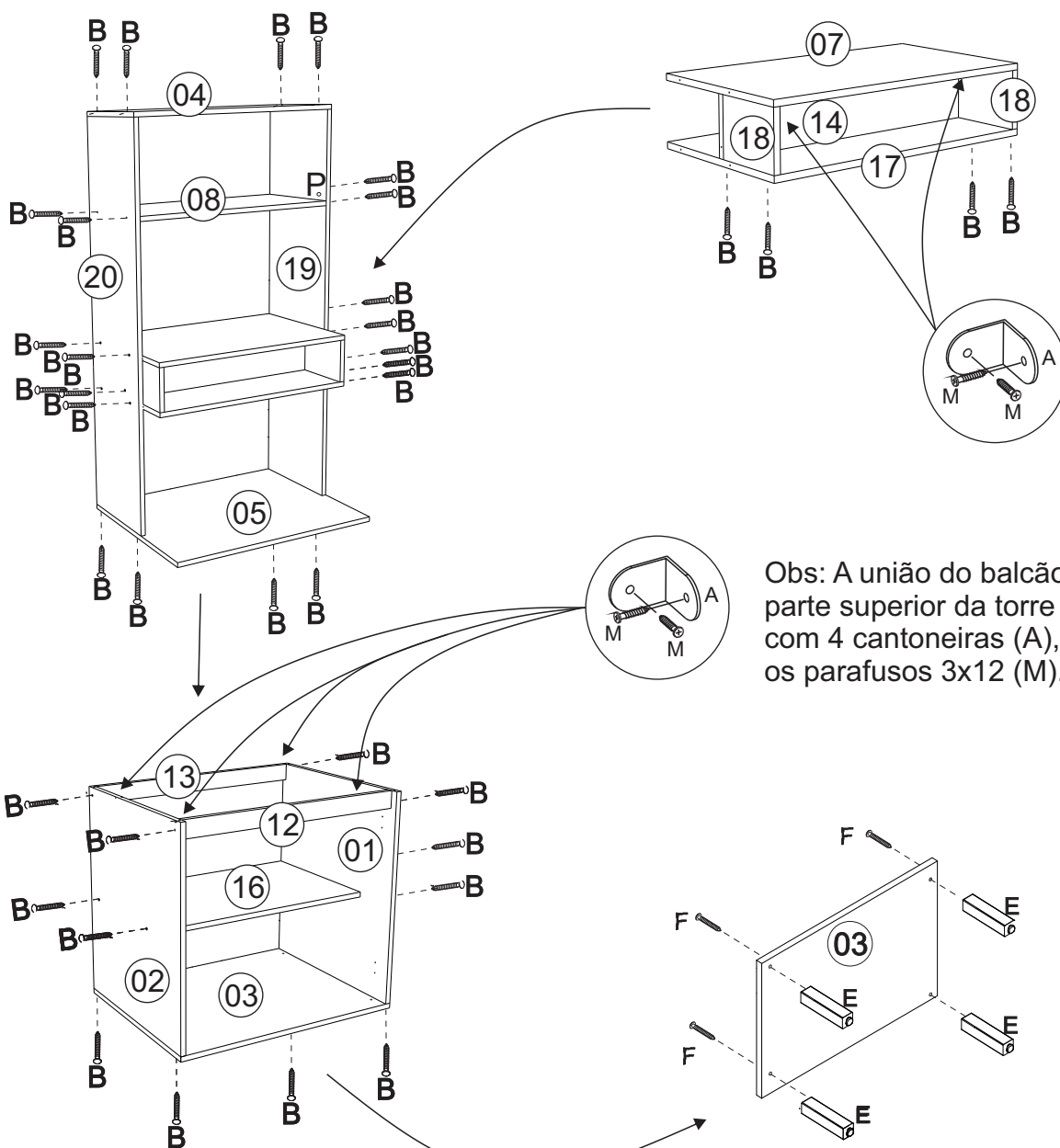

Obs: A união do balcão com a parte superior da torre se faz com 4 cantoneiras (A), e com os parafusos 3x12 (M).

02 Montagem/Montaje

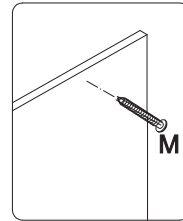
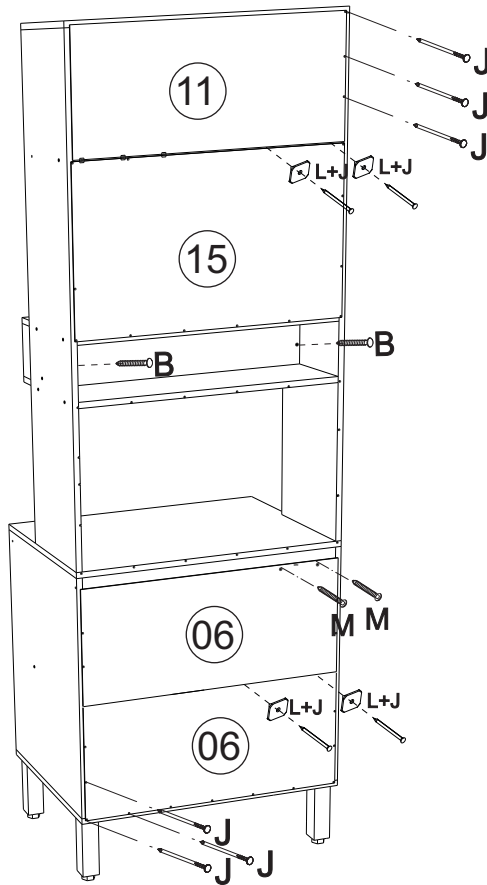

*Colocar um parafuso (M) a cada 100mm
 *Colocar un tornillo (M) cada 100mm
 *Place a screw (M) every 100mm

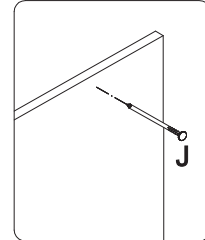

*Colocar um prego (J) a cada 100mm
 *Colocar un clavo (J) cada 100mm
 *Place a nail every (J) 100mm

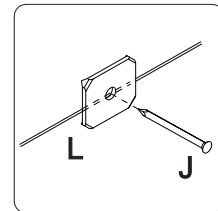

*Usar o prego (J) e a junção (L) a cada 100mm
 *Usar el clavo (J) y la junta (L) cada 100mm
 *Use the nail (J) and the joint (L) every 100mm

03 Montagem/Montaje

