

HENNInd. e Com. de Móveis Henn
Mondai - SC - Brasil

☎ +55 49 3674.3500

📷 📱 @moveishenn
www.henn.com.br**INSTRUÇÕES DE
MONTAGEM**INSTRUCCIONES DE MONTAJE
ASSEMBLY INSTRUCTIONS**Torre Quente 01 Forno 715mm Requite | Torre
Caliente 01 Horno 715mm Requite | Hot Tower 01 Oven 715mm
Requite**

C644-217 Nature/Areia HP

C644-218 Nature/Nature/Areia HP

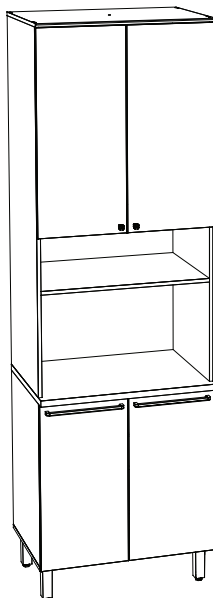
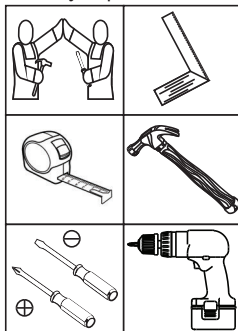
Requisitos para montagem
Requisitos para la montaje
Assembly RequirementsImagens meramente ilustrativas,
não acompanha o produto.
Imágenes ilustrativas, no incluidas
con el producto.
Illustrative images, not included
with the product.**AVISO**

Para limpeza de seu móvel, use uma franela seca ou umedecida, e não utilize produtos químicos que possam danificar seu produto.

SISTEMA DE MONTAGEM

O sistema de montagem dos produtos, funciona de acordo com a ordem crescente dos números indicados no desenho. Ex: 01, 02, 03, 04... até a conclusão da montagem.

ASSISTÊNCIA TÉCNICA

Para solicitação de Assistência Técnica você consumidor deverá entrar em contato com o Lojista o qual você realizou a compra deste produto e solicitar a assistência técnica das peças avariadas. A garantia abrange todas as peças, partes e componentes que eventualmente venham apresentar defeito de fabricação no prazo de 03 (três) meses, contando a partir da entrega do produto ao consumidor, mediante nota fiscal de compra. Se houver qualquer alteração na estrutura do produto ou ocorrer defeito por negligência do montador/consumidor em relação a instrução de montagem e manuseio, não será fornecido assistência técnica gratuita.

ADVERTENCIA

Para limpieza de su móvil, use una franela seca o húmeda, y no utilice productos químicos que puedan dañar su producto.

SISTEMA DE MONTAJE

El sistema de montaje de los productos funciona de acuerdo con el orden creciente de los números indicados en el dibujo. Ej: 01, 02, 03, 04... hasta la conclusión del montaje.

ASISTENCIA TÉCNICA

Para solicitar Asistencia Técnica, el consumidor debe comunicarse con el Comercio que usted realizó la compra de este producto y solicita asistencia técnica para las partes dañadas. La garantía cubre todas las partes, piezas y componentes que eventualmente puedan presentar defecto de fabricación en el plazo de 03 (tres) meses, contados a partir de la entrega del producto al consumidor, mediante factura de compra. Si se produce algún cambio en la estructura del producto o se produce un defecto por negligencia del montador/consumidor en relación con las instrucciones de montaje y manipulación, no se prestará asistencia técnica gratuita.

NOTICE

To clean your furniture, use a dry or wet cloth, and do not use chemicals that may damage your product.

ASSEMBLY SYSTEM

The products' assembly system works according to the increasing order of the indicated numbers. For example: 01, 02, 03, 04 ... to the end of the assembly.

TECHNICAL ASSISTANCE

To request Technical Assistance, the consumer must contact the retailer from whom you purchased this product and request technical assistance for the damaged parts. The warranty covers all parts, parts and components that may eventually present a manufacturing defect within a period of 03 (three) months, counting from the delivery of the product to the consumer, by means of a purchase invoice. If there is any change in the structure of the product or defect occurs due to negligence of the assembler/consumer in relation to the assembly and handling instruction, free technical assistance will not be provided.

ACESSÓRIOS | ACCESORIOS | ACCESSORIES

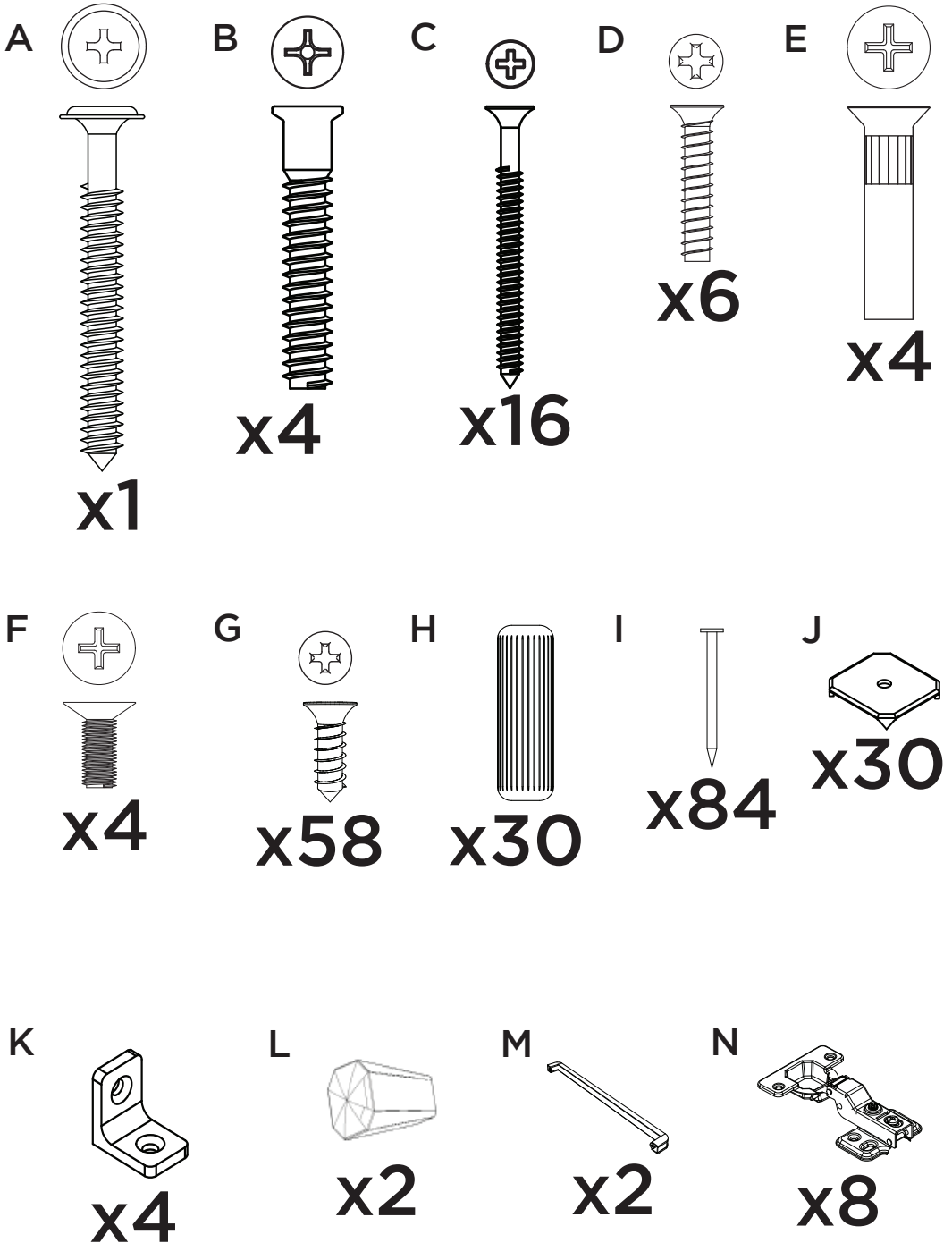

Parafusos em escala
Tornillos escalados
Scaled screws

1:1

ACESSÓRIOS | ACCESORIOS | ACCESSORIES

O

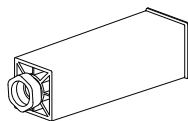

x4

P

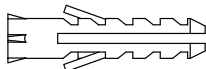

x1

Q

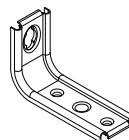

x1

R

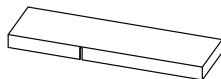

x1

S

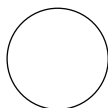

x18

T

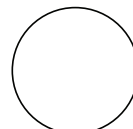

x12

U

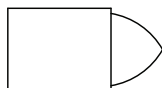

x3

V

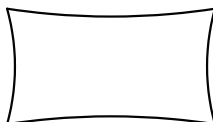

x1

W

HENN

x1

X



x4

Y

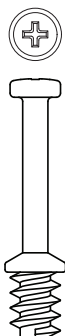

x8

Z



x8



Os parafusos (E/F) devem ser usados somente quando este módulo for acoplado a outro módulo componível Henn.



Los tornillos (E/F) se debe utilizar sólo cuando el módulo está conectado a otro módulo compatible Henn.



Screws (E/F) are to be used only when this module is mated to another Henn buildable module.

LISTA DE PEÇAS | LISTA DE PIEZAS | LIST OF PIECES

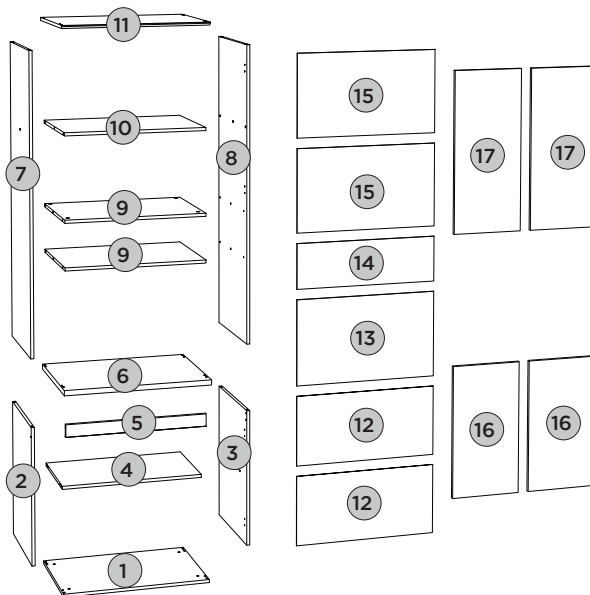

Item	Caixa Caja Box	Qtd Ctd Qty	Descrição Descripción Description	Dimensões (mm) Dimensiones (mm)		
				Comprimento Largo Length	Largura Ancho Width	Espessura Grosor Thickness
1	1/1	01	BASE BASE BASE	715	490	15
2	1/1	01	LATERAL ESQUERDA INFERIOR LATERAL IZQUIERDA INFERIOR LEFT SIDE LOWER	660	490	15
3	1/1	01	LATERAL DIREITA INFERIOR LATERAL DERECHA INFERIOR RIGHT SIDE LOWER	660	490	15
4	1/1	01	PRATELEIRA ESTANTE SHELF	684	400	15
5	1/1	01	TRAVESSA FRONTAL TRAVESAÑO FRONTAL FRONT CROSSBAR	684	60	15
6	1/1	01	TAMPO 25MM TAPA 25MM TOP 25MM	715	533	25
7	1/1	01	LATERAL ESQUERDA SUPERIOR LATERAL IZQUIERDA SUPERIOR UPPER LEFT SIDE	1445	490	15
8	1/1	01	LATERAL DIREITA SUPERIOR LATERAL DERECHA SUPERIOR UPPER RIGHT SIDE	1445	490	15
9	1/1	02	PRATELEIRA CENTRAL ESTANTE CENTRAL CENTRAL SHELF	684	490	15
10	1/1	01	PRATELEIRA SUPERIOR ESTANTE SUPERIOR UPPER SHELF	684	490	15
11	1/1	01	TAMPO TAPA TOP	715	517	15
12	1/1	02	FUNDO INFERIOR FONDO INFERIOR LOWER BOTTOM	708	343	3
13	1/1	01	FUNDO CENTRAL FONDO CENTRAL CENTRAL FUND	708	422	3
14	1/1	01	FUNDO MENOR FONDO MÁS PEQUEÑO SMALLER BOTTOM	708	223	3
15	1/1	02	FUNDO SUPERIOR FONDO SUPERIOR UPPER BOTTOM	708	410	3
16	1/1	02	PORTA INFERIOR PUERTA INFERIOR LOWER DOOR	665	354	15
17	1/1	02	PORTA PUERTA DOOR	813	354	15





PASSO 1

ITM/C644-

PEÇAS REQUERIDAS

1	BASE	x1
2	LATERAL ESQUERDA INFERIOR	x1
3	LATERAL DIREITA INFERIOR	x1
4	PRATELEIRA	x1
5	TRAVESSA FRONTAL	x1

ACESSÓRIOS REQUERIDOS

B		04
H		14
O		04
V		

FERRAMENTAS NECESSÁRIAS

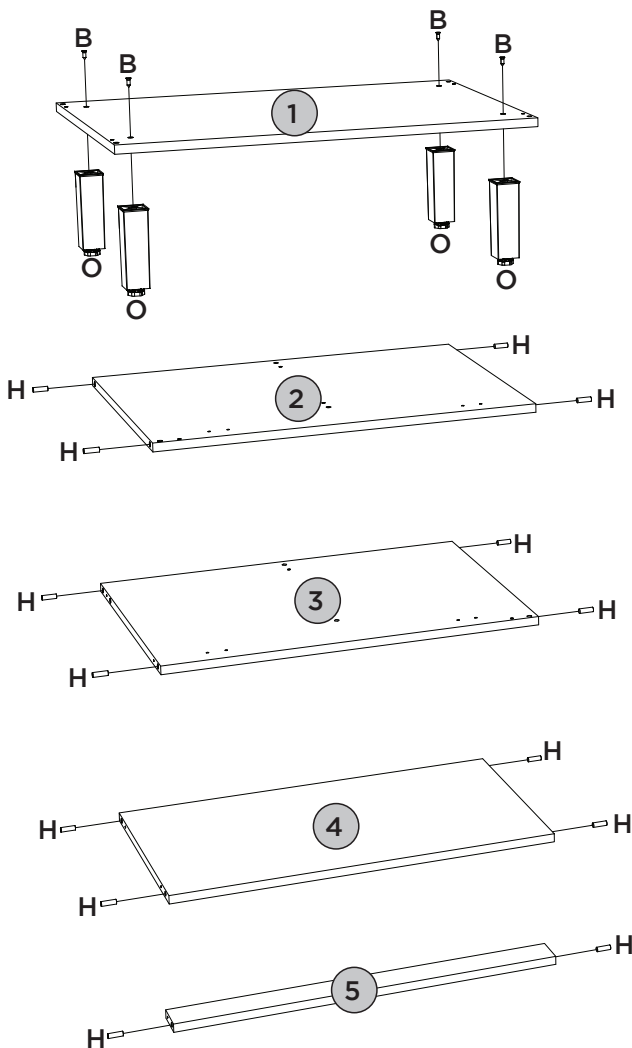
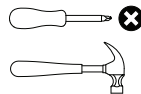

Utilizar o sachê de cola (V) em todas as cavilhas (H) do produto.

Con el pegamento sobre (V) en todos los pernos (H) producto.

Use the glue sachet (V) on all the pegs (H) of the product.



PASSO 2

ITM/C644-

PEÇAS REQUERIDAS

7	LATERAL ESQUERDA SUPERIOR	x1
8	LATERAL DIREITA SUPERIOR	x1
9	PRATELEIRA CENTRAL	x2
10	PRATELEIRA SUPERIOR	x1

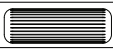
ACESSÓRIOS REQUERIDOS

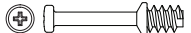
H		16
V		
Y		08

FERRAMENTAS NECESSÁRIAS

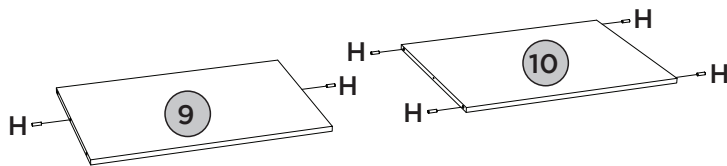
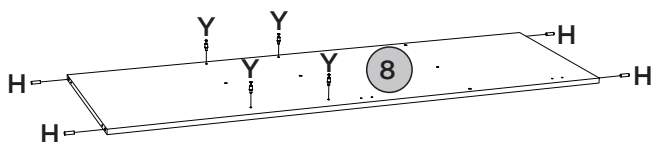
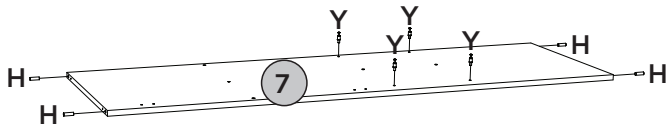
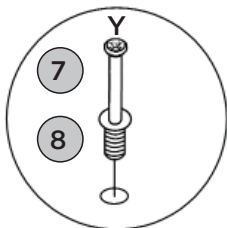
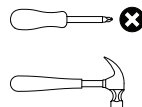



PASSO 3

PEÇAS REQUERIDAS

1	BASE	x1
2	LATERAL ESQUERDA INFERIOR	x1
3	LATERAL DIREITA INFERIOR	x1
4	PRATELEIRA	x1
5	TRAVESSA FRONTAL	x1

ACESSÓRIOS REQUERIDOS

C		10
V		

FERRAMENTAS NECESSÁRIAS

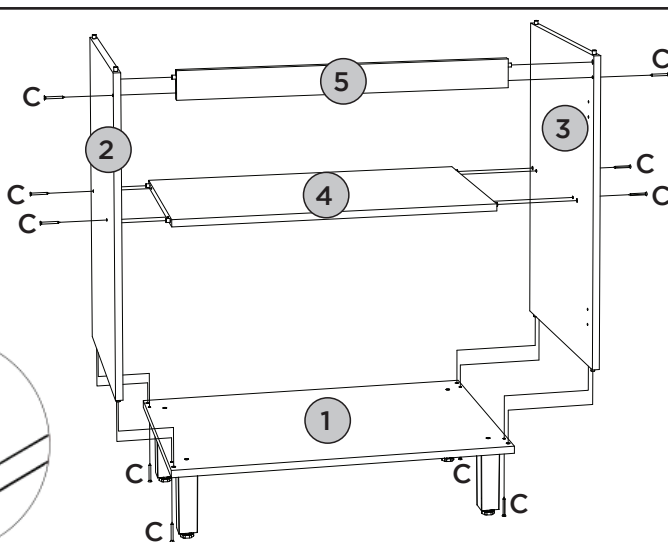
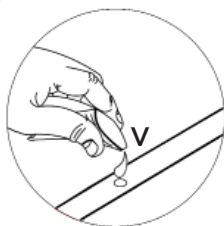
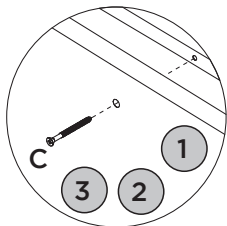
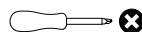





PASSO 4

ITM/C644-

PEÇAS REQUERIDAS

6	TAMPO 25MM	x1
7	LATERAL ESQUERDA SUPERIOR	x1
8	LATERAL DIREITA SUPERIOR	x1
9	PRATELEIRA CENTRAL	x2
10	PRATELEIRA SUPERIOR	x1
11	TAMPO	x1

ACESSÓRIOS REQUERIDOS

C		06
V		
X		04
Z		08

FERRAMENTAS NECESSÁRIAS

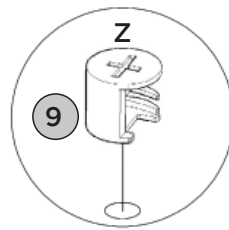
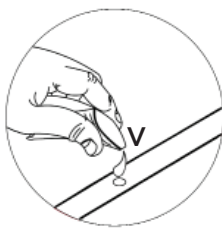
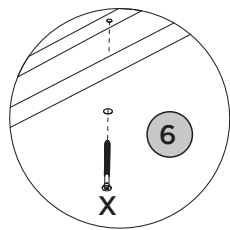
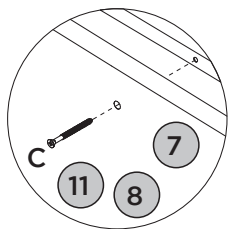
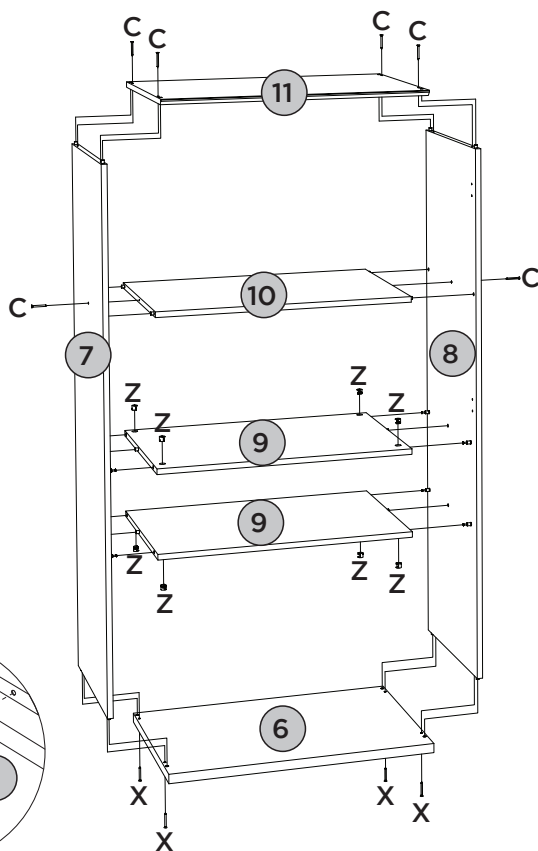
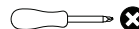

PASSO 5

ITM/C644-

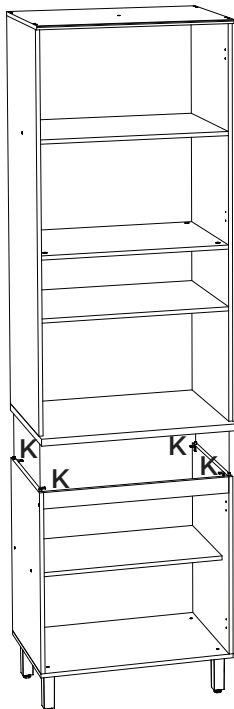

ACESSÓRIOS REQUERIDOS

G		08
K		04
V		

FERRAMENTAS NECESSÁRIAS

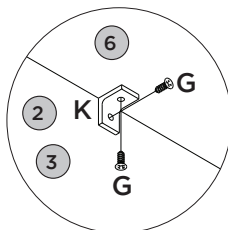
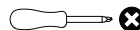

PASSO 6

PEÇAS REQUERIDAS

12	FUNDO INFERIOR	x2
13	FUNDO CENTRAL	x1
14	FUNDO MENOR	x1
15	FUNDO SUPERIOR	x2

ACESSÓRIOS REQUERIDOS

I		84
J		30

FERRAMENTAS NECESSÁRIAS



Fixar os pregos a uma distância de 100mm de um para outro.

Fijar las uñas a un distancia de 100mm uno a otro.

Fix the nails at a distance of 100mm from one to the other

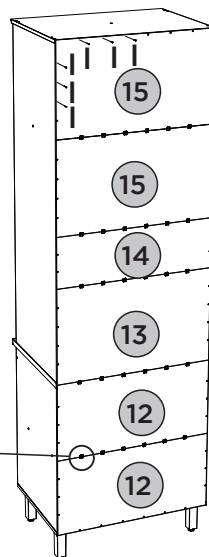
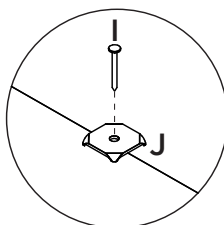

PEÇAS REQUERIDAS

16	PORTA INFERIOR	x2
17	PORTA	x2

ACESSÓRIOS REQUERIDOS

G		16
N		08



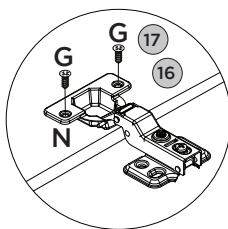
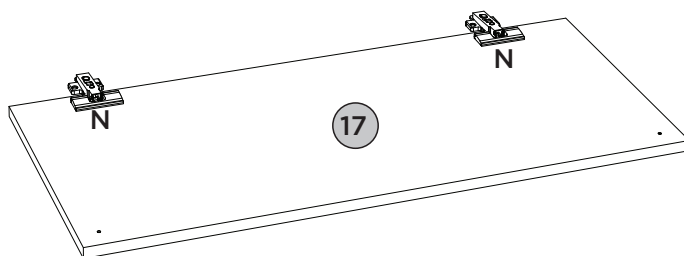
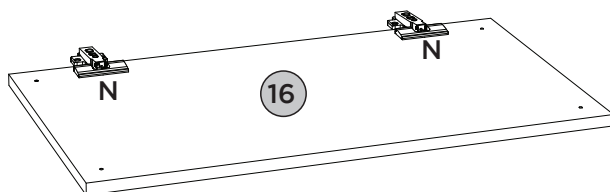
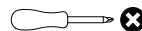



FERRAMENTAS NECESSÁRIAS



PEÇAS REQUERIDAS

16	PORTA INFERIOR	x2
17	PORTA	x2

ACESSÓRIOS REQUERIDOS

D	 	06
G	 	32
L		02
M		02

FERRAMENTAS NECESSÁRIAS

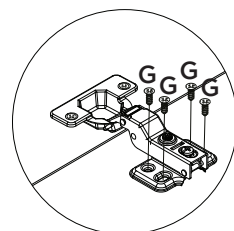
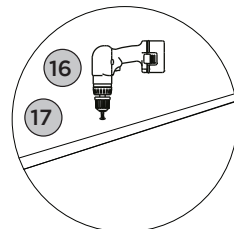
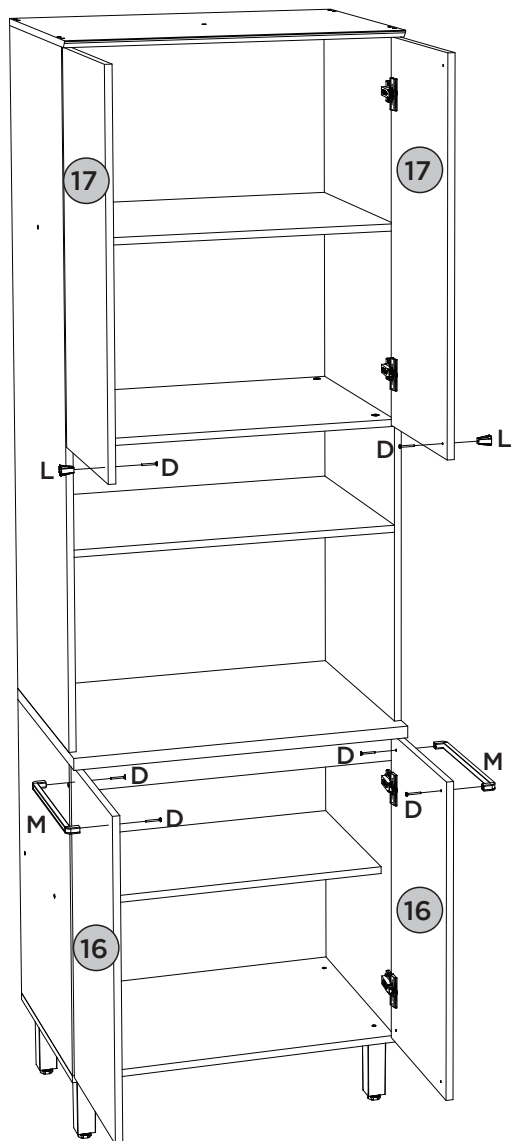
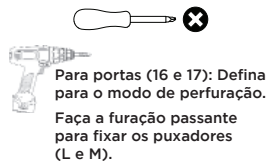

ACESSÓRIOS REQUERIDOS

A		01
G		02
P		01
Q		01
R		01

S		18
T		12
U		03
W		01

FERRAMENTAS NECESSÁRIAS



Para parede: Ajustar no modo perfuração
Para peça (11): Usar torque 5

Pesos máximos recomendados com carga distribuída
Peso máximo recomendado con la carga distribuida
Recommended maximum weight with distributed load.

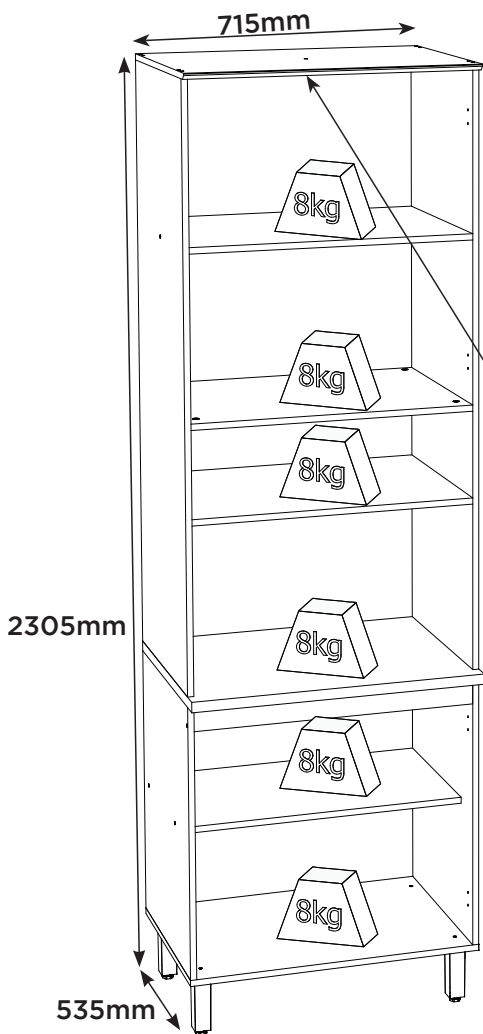

PERFECT CORRECTION
CORRECCIÓN PERFECTA

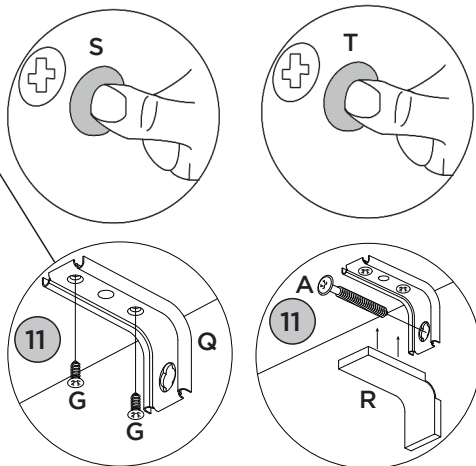
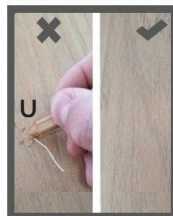

RECOMENDAÇÃO

Para fixar o móvel na parede usar o suporte de fixação (Q), o parafuso 4,0x14mm CHT (G), a Bucha 8mm (P) e o parafuso 5,0x50mm FLA (A).

RECOMENDACIÓN

Para conectar el móvil a la pared con el soporte (Q), tornillo 4,0x14mm CHT (G), el casquillo de 8 mm (P) y el 5,0 x50mm tornillo FLA (A).

RECOMMENDATION

To fix the furniture to the wall use the fixing bracket (Q), the 4,0x14mm CHT (G) screw, the 8mm bushing (P) and the 5.0x50mm FLA screw (A).

Produto Concluído
Producto terminado
Finished Product

