

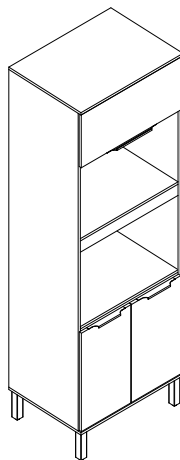

Rodovia SC-492 - Km 10 - B. Industrial  
89905-000 - Bandeirante - SC  
Fone: (49) 3622-4549  
e-mail: mxmoveis@mxmoveis.com.br



**Ref. TVE02**

*Torre Quente*  
*Armario p/hornos*  
*Cozinha/Cocina*  
*Verace*

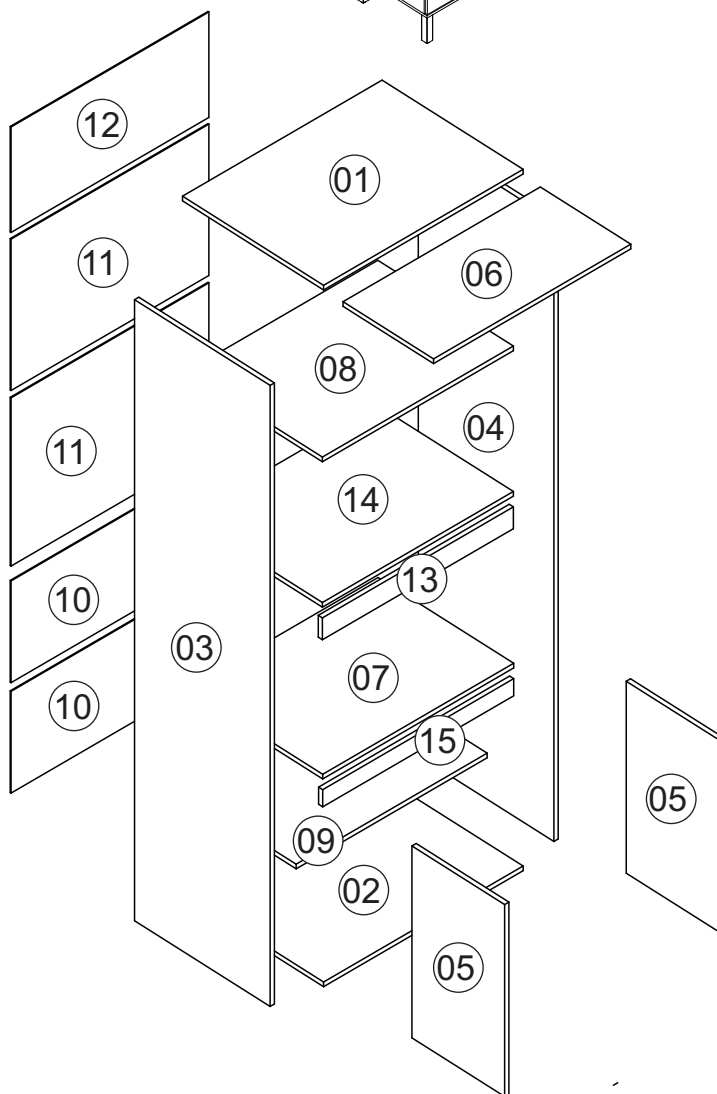

Nº	CÓDIGO ASSISTÊNCIA	NOME DA PEÇA/DESCRIPCIÓN PIEZAS	MEDIDAS (mm)	QTD.	CÓDIGO DAS PEÇAS/CÓDIGO PIEZAS			
					HAVANA	TAUPE	TAUPE	OFF WHITE
01	TVE02.05.00	Base superior/Base superior	700x516x15	01	159224		159218	
02	TVE02.01.00	Base inferior/Base inferior	700x516x15	01	66143		66196	
03	TVE02.18.00	Lateral externa esquerda/Lateral izquierda	1990x496x15	01	52270		52389	
04	TVE02.17.00	Lateral externa direita/Lateral derecha	1990x496x15	01	52271		52390	
05	TVE02.25.01	Porta/Puerta	615x339x15	02		64535		64569
06	TVE02.25.00	Porta aereo basculante/Puerta	692x331x15	01		64536		64570
07	TVE02.33.00	Tampo/Tapa	670x516x25	01	17686		176673	
08	TVE02.01.01	Base basculante/Base	670x496x15	01	64556		64571	
09	TVE02.27.02	Prateleira interna/Repisa	670x400x15	01	64538		64538	
10	TVE02.13.01	Forro balcão/Revés	694x326x2.5	02	47482		47482	
11	TVE02.13.04	Forro forno/Revés horno	694x513x2.5	02	52274		78411	
12	TVE02.13.02	Forro aereo basculante/Revés superior	694x338x2.5	01	58715		58715	
13	TVE02.28.00	Ripa frontal/Travesaño delantero	670x70x15	01	159225		64573	
14	TVE02.02.00	Base micro/Base	670x496x15	01	52277		52398	
15	TVE02.37.00	Ripa balcão/Travesaño	670x55x15	01	159226		159220	

# Ferragens/Herrajes

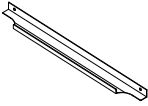
**A**  **03x**  
Cód 1816  
Puxador

**B**  **24x**  
Cód 12537  
Parafuso 4,0x50mm Cht.

**C**  **24x**  
Cód 7604  
Parafuso 4,0x12mm Cht.

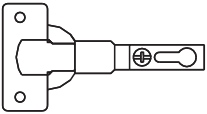
**D**  **06x**  
Cód 10269  
Kit dobradiça 26mm

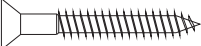
**E**  **08x**  
Cód 692  
Parafuso 3,5x25mm Cht.

**F**  **04x**  
Cód 1979  
Parafuso 5,0x50mm Cht.

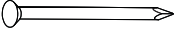
**G**  **78x**  
Cód 822  
Prego 8x8

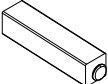
**H**  **04x**  
Cód 5885  
Pé plástico

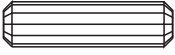
**I**  **04x**  
Cód 873  
Cavilha

**J**  **02x**  
Cód 18804  
Calço Alto

**K**  **01x**  
Cód 1205  
Pistão a gás

**L**  **20x**  
Cód 7169  
Fixador costa

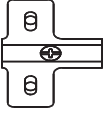

**M**  **04x**  
Cód 691  
Parafuso 3,5x40mm Cht.

**N**  **04x**  
Cód 12539  
Calço Dobradiça

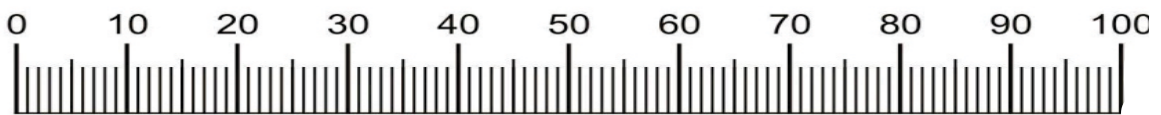
**O**  **06x**  
Cód 11413  
Parafuso 3,0x12mm Cht.

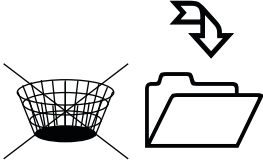
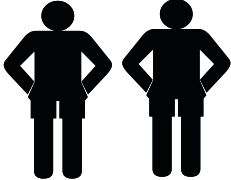

Medidas em mm

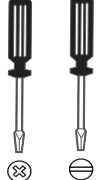
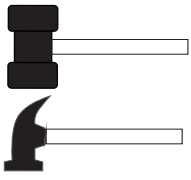
		 <b>1:00</b>		
---	---	---	--	---

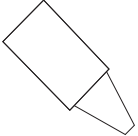
	<p>Produto para ser aplicado em caso de riscos na superfície</p>
---	--

Giz para madeira

# Pré-Montagem/Preparación Piezas

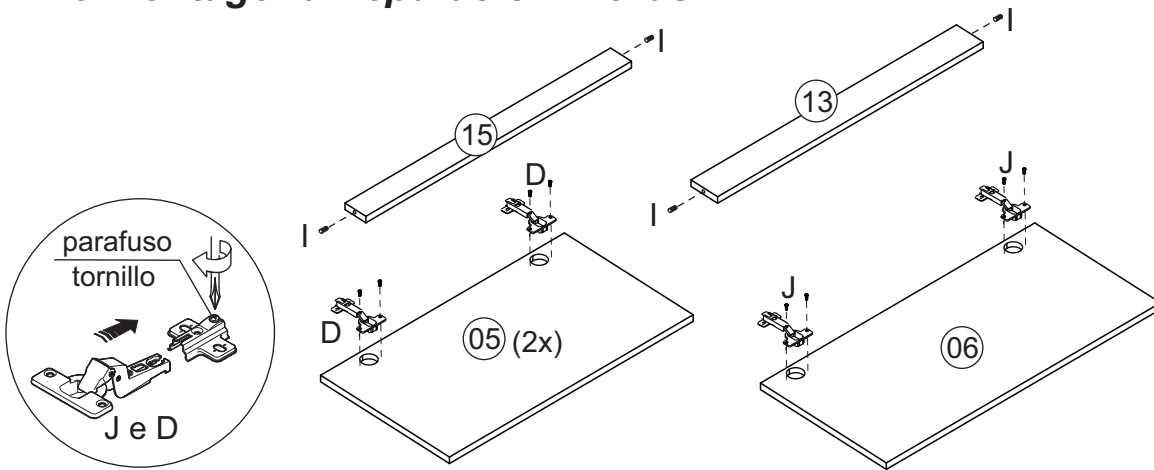

# Montagem/Montaje

01

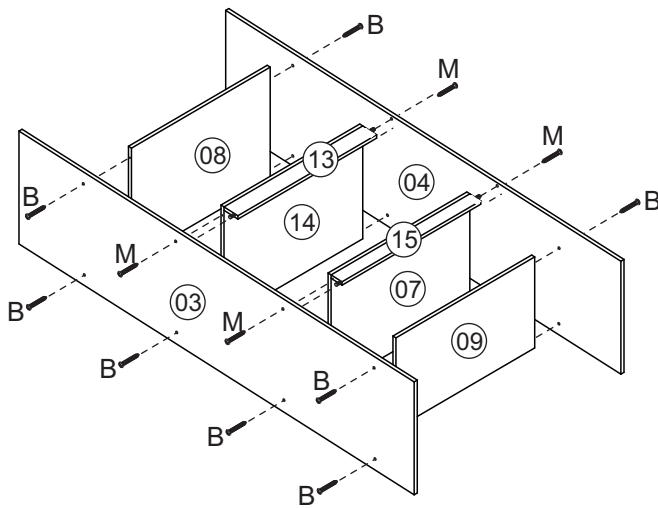

02

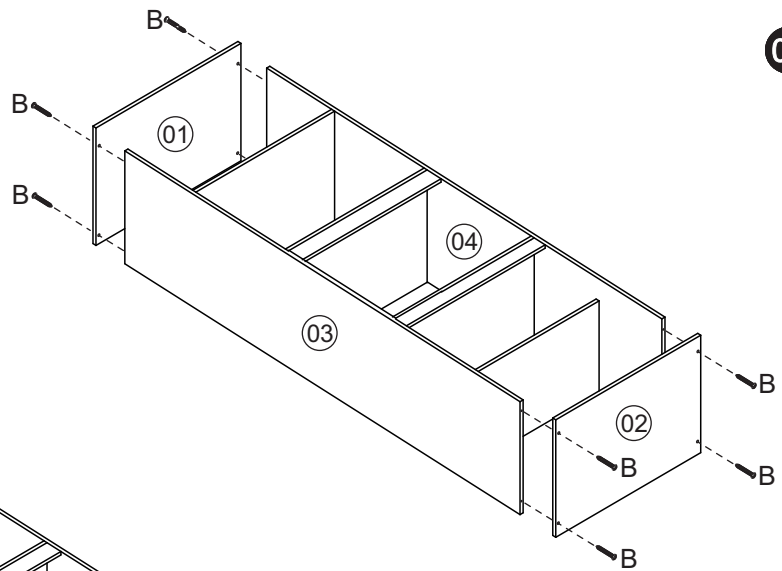

03

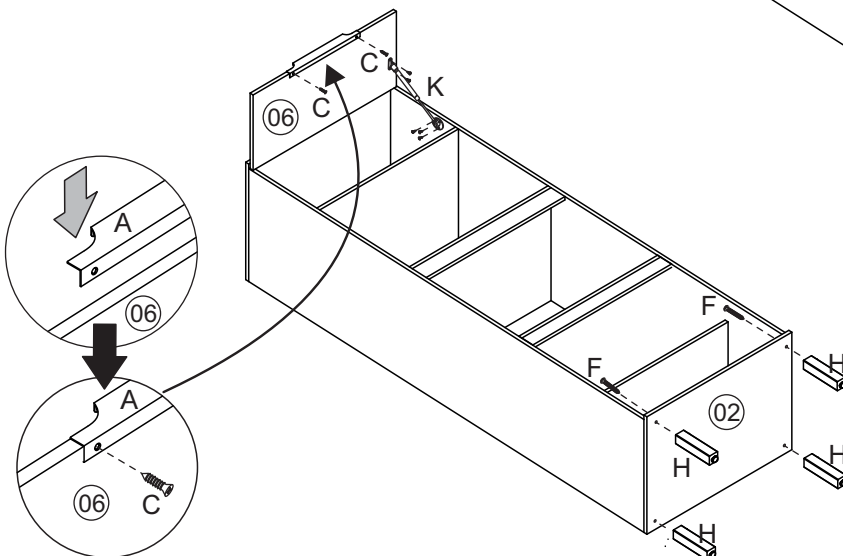

# Montagem/Montaje

04

## ATENÇÃO!!!

É importante colocar o móvel no esquadro antes de fixar as costas. Para isto utilize uma trena observando que a medida 1 deve ser igual à medida 2.

## ATENCIÓN!!!

Es importante hacer una escuadra perfecta entre el fondo y la estructura del mueble. Observe que la medida 1 debe ser la misma que la medida 2.

**Quando usar forno não fixar este forro (11)**  
**Cuando usar el horno no utilice este revés (11)**

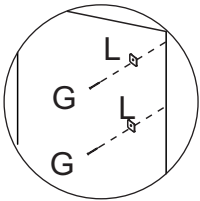

\*Usar o prego (G) e a junção (L) a cada 100mm.

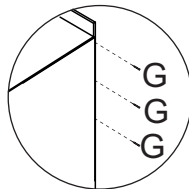

\*Colocar um prego (G) a cada 100mm.

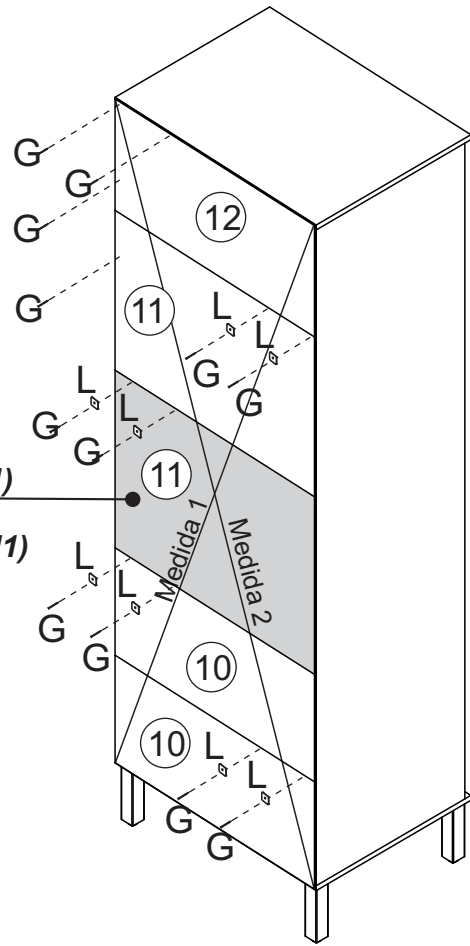

05

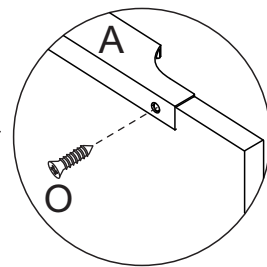
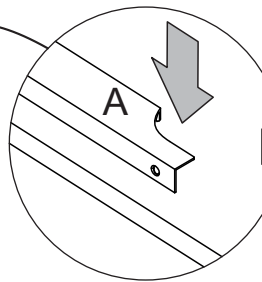
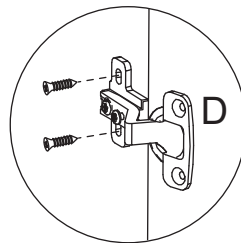
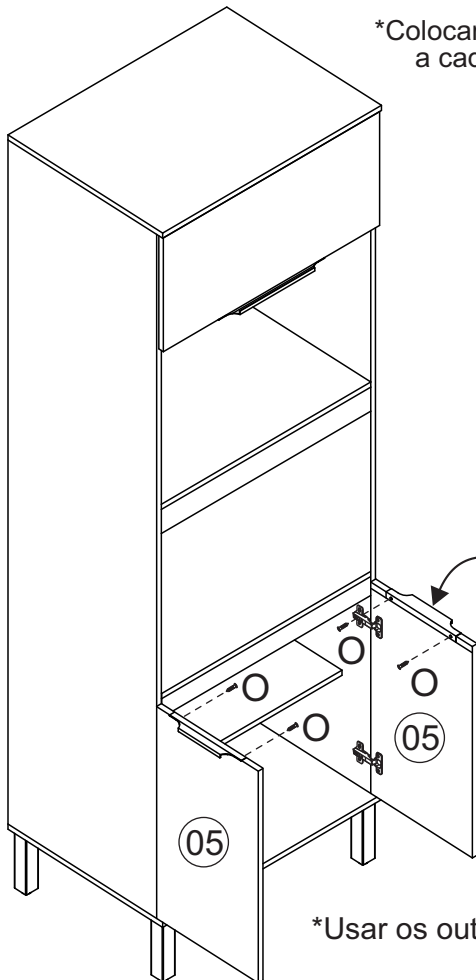

\*Usar os outros 4 parafusos (E) para unir este módulo a outro.  
 Usar los otros tornillos (E) para unirse este modulo a otro.

## Limpeza/Limpieza

- ✘ Use um pano levemente umedecido com água, seguido de pano seco.
- ✘ Use solamente un paño húmedo con agua y después un paño seco.
- ✘ Nunca utilize produtos químicos ou abrasivos.
- ✘ No utilice productos quimicos o abrasivos.